

FOR EVERYTHING IN ELECTRONICS

Wireless World

AUGUST 1983

80p

Daisywheel typewriter interface

Spectrum analysis on the cheap

Did Morse get it right?

Ultrasonics for robots



How to stop a travelling wave

Australia A\$ 2.70
Canada C\$ 3.25
Denmark DKR. 33.25
Germany DM 7.00
Greece DRA. 190.00
Holland DFL. 8 50
Italy L 3700
New Zealand NZ\$ 3.00
Norway NKR. 26.00
Singapore M\$ 5.50
Spain PTS 275 00
Switzerland FR. 7.00
U S A. \$ 3 75

The PSG520H



a small, lightweight
synthesized signal generator
for field or bench use

100kHz to 520MHz

Runs from clip-on NiCd battery pack, external 12Vd.c.
(vehicle battery via cigar lighter socket) or,
from any standard a.c. mains supply

Reverse power protection to 50W (standard)

Excellent specification and features

from



Farnell

FARNELL INSTRUMENTS LIMITED · WETHERBY · WEST YORKSHIRE LS22 4DH · TELEPHONE (0937) 61961 · TELEX 55478 FARINT G
REGIONAL OFFICE (SOUTH) · DAVENPORT HOUSE · BOWERS WAY · HARPENDEN · HERTS. AL5 4HX · TEL. (05827) 69071 · TELEX 826307
WW-001 FOR FURTHER DETAILS

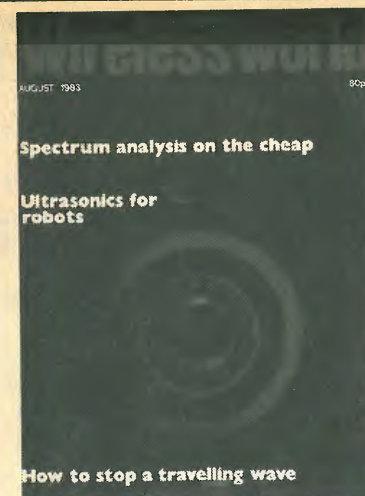

Red and green arcs of light represent crests and troughs of an electromagnetic wave brought to rest in the laboratory, as described by Professor Jennison on pages 36-38.

NEXT MONTH

During his work on crises control R. E. Young saw a connexion between shock caused by a mass of data too enormous and possibly suspect to comprehend and the 'shell' condition of hyperautism in the mentally handicapped. R. E. Y. describes how electronics is now being applied to help people escape from the shell by communication.

Ian Wade's RTTY program runs on a basic Nascom 1 or 2 microcomputer and displays received text on a tv screen in lower-case letters, transmitted text in upper case.

Exceeding its designers expectations, the 6809-based Forth computer can be used with disc drives requiring high data-transfer rates - including Sony's microdrive and 8in floppy-disc drives.

Current issue price 80p, back issues (if available) £1, at Retail and Trade Counter, Units 1 & 2, Bankside Industrial Centre, Hopton Street, London SE1. Available on microfilm; please contact editor.

By post, current issue £1.23, back issues (if available) £1.80, order and payments to EEP General Sales Dept., Quadrant House, The Quadrant, Sutton, Surrey SM2 5AS Tel: 01-661 8668.

Editorial & Advertising offices: Quadrant House, The Quadrant, Sutton, Surrey SM2 5AS.

Telephones: Editorial 01-661 3614. Advertising 01-661 3130. See leader page. Telex: 892084 BISPRS G.

Subscription rates: 1 year £14 UK and £17 outside UK.

Student rates: 1 year £9.35 UK and £11.70 outside UK.

Distribution: Quadrant House, The Quadrant, Sutton, Surrey SM2 5AS. Telephone 01-661 3248.

Subscriptions: Oakfield House, Perry-mount Road, Haywards Heath, Sussex RH16 3DH. Telephone: 0444 459188. Please notify a change of address.

USA: \$44 surface mail, \$93.80 airmail. Business Press International, Subscriptions Office, 205 E. 42nd Street, NY 10017.

USA mailing agents: Expeditors of the Printed Word Ltd, 527 Madison Avenue, Suite 1217, New York, NY 10022. 2nd class postage paid at New York.

© Business Press International Ltd 1983 ISSN 0043 6062.

FOR EVERYTHING IN ELECTRONICS Wirelessworld

AUGUST 1983

VOL 89 NO 1571

- 21 **ENGINEERING, NOT POLITICS**
- 22 **COMMUNICATIONS COMMENTARY**
IARU accountability CB collapse? HF jamming
- 24 **TYPEWRITER TO DAISYWHEEL PRINTER**
by N. Duffy
- 29 **AERIAL INEFFICIENCY AT SEA**
by J. J. Wiseman
- 32 **LOUDSPEAKER MEASUREMENTS SIMPLIFIED**
by P. F. Dobbins
- 36 **ELECTRIC CHARGE FROM A RADIO WAVE**
by R. C. Jennison
- 38 **LITERATURE RECEIVED**
Application notes and equipment data
- 39 **CIRCUIT IDEAS**
Monitor conversion Cable reflectometer Rcm selector
- 42 **SHORTCUTS IN CIRCUIT ANALYSIS**
by W. A. Vincent
- 44 **FORTH COMPUTER**
by B. Woodroffe
- 46 **300BAUD FULL-DUPLEX MODEM**
by D. Richards
- 49 **LETTERS TO THE EDITOR**
Electromagnetic Doppler Heretics feedback Waves in space
- 53 **BOOKS RECEIVED**
- 54 **ULTRASONIC RANGING FOR ROBOTS**
by H. W. Gleaves
- 58 **HOBBYIST'S SPECTRUM ANALYSER**
by R. Hartkopf
- 62 **DID MORSE GET IT RIGHT?**
by A. S. Chester
- 64 **ELECTRONIC MAIL ORDER FOR ELECTRONICS**
Estelle Rewtel and Cashtel
- 65 **NEWS OF THE MONTH**
Microchip mic Erasable optical disc Colour with mono crt
- 68 **ASSEMBLY LANGUAGE PROGRAMMING**
by R. F. Coates
- 70 **TWO-METRE TRANSCEIVER**
by T. Forrester
- 74 **NEW PRODUCTS**
Logic game Eurocube computer Autodial modem

CHERRY PROTO-PADS

Membrane keyboards – cut out for custom-design.

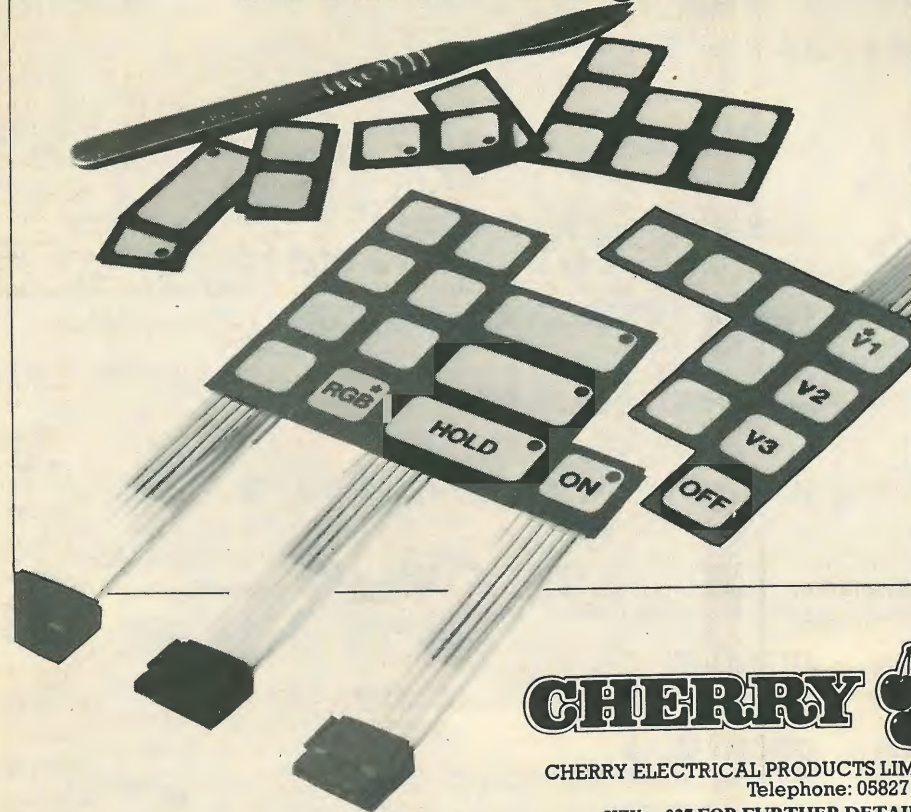

CHERRY MEMBRANES

CHERRY ELECTRICAL PRODUCTS LIMITED, Coldharbour Lane, Harpenden, Herts AL5 4UN
 Telephone: 05827 63100 Telex: 826012 CHERRY G
 WW - 037 FOR FURTHER DETAILS

Now Cherry offers you a cost-effective answer to prototype development, in application areas hitherto not possible with conventional keyboards.

The Protopad range of self-adhesive membrane panels offers you a wide choice, with keypad configurations of 4 x 4, 2 x 4 and 1 x 4 in single or double pad size, with or without LED windows.

Their modular design makes for easier layout and unwanted pads can be progressively cut away, without disturbing circuit continuity.

For improved operator keying, all pad areas are embossed and have a special finish to accept custom legends using dry transfers or water-based ink pen.

But most important of all, Protopads carry the Cherry name that assures you of no short-cuts in reliability and performance.

'Protopad design evaluation modules are available, ex-stock, from our distributors.'

Semicomps, telephone: (0535) 67921
 Tenco, telephone: (0793) 485255



6FT. PARABOLIC DISHES

FROM ONLY £85 PLUS V.A.T.

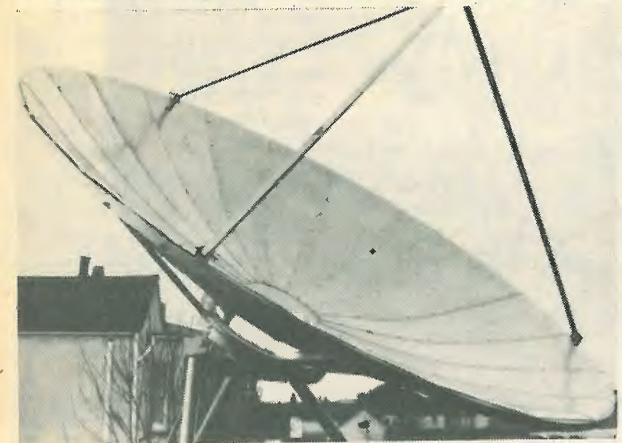

6ft. dia. dishes, feed horns and electronics for use in 4GHz satellite reception. GaAs Fet transistors, SMA connectors, P.T.F.E., etc. available. Please send s.a.e. for full details and data sheets.

Harrison Bros.

Electronic Distributors

22 Milton Road, Westcliff-on-Sea, Essex SS0 7JX
 Tel. Southend (0702) 332338

WW - 010 FOR FURTHER DETAILS

Miscellaneous Hardware for sale

Cabinets (6ft)	£95
Delta Data VDUs	£50
Centronics 101 Printers	£40
8K Micronova Memory	£45
D.G. Cassette Tape Drive	£65
Series 30 Diablo Drives	£245
Tally 2200 Printer	£245
Teletype ASR 33	£15
Olivetti TE 300	£20
Nova 800 Memory	P.O.A.

Call ALASTAIR DODS 01-467 1985/8489

WW - 031 FOR FURTHER DETAILS

1.5 GHz UP-CONVERTER 260

works with any 240-350 MHz generator



Designed for economic testing and calibration of 1.5 GHz communications equipment, the Model 260 is a linear heterodyne up-converter employing advanced techniques to generate a very clean signal in the 1440-1550 MHz band from signal generator inputs 1200 MHz lower. It has zero insertion loss and allows the input signal generator controls to be used directly to set the output signal level and modulation conditions. Full accuracy and stability is ensured by phase-locking the internal 1200 MHz local oscillator to the signal generator frequency standard.

Full details from:
 Techtest Ltd, Street Court, Kingsland
 Leominster, Herefordshire HR6 9QA, England
 Telephone: KINGSLAND (056881) 744. Telex: 837264

WW - 054 FOR FURTHER DETAILS

STATIC DRAIN AND LIGHTNING PROTECTION COMPONENTS

Line Transformer Type DDL/14A/1

To provide a DC path for static drain between coaxial centre contacts and earth.

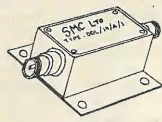

Brief Specifications

Freq. Range	30-1000 MHz
Impedance	50 Ohms
Power Rating	50 or 100 W
Terminations	BNC or 'N' to customers' requirements

Highpass Filter Type 2DLO1

To protect VHF and UHF equipment from static discharges and lightning induced EMF which predominate below 20MHz.

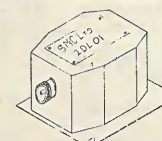

Brief specifications

Pass band	20-1000 MHz
Impedance	50 Ohms
Power Rating	20 watts
Terminations	BNC, N or to customers' requirements

Gas Discharge Lightning Arrestor Type LA1

To provide both protection from lightning strikes and prevention of significant static build-up on antennas and transmission lines.

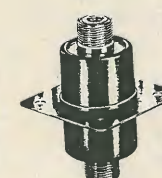

Brief Specifications

Freq. Range	0.54 MHz
Impedance	50/75 Ohms
Power Ratings	1Kw
Terminations	SO239 only
Surge Capability:	10 or more surges of 15,000 amperes in 5 microseconds

SMC also supply a wide range of RF Baluns Rx to 30KW 1.5-30 MHz, ground or antenna mounted, with most combinations of connector or open wire termination earth rods, earthing wire, etc.

SOUTH MIDLANDS COMMUNICATIONS LTD.

RUMBRIDGE ST., TOTTON
 SOUTHAMPTON SO4 4DP

Telex: 477351 SMCMM G
 Tel: Totton (0703) 867333

WW - 051 FOR FURTHER DETAILS

Keep those Contacts CLEAN

BY USING A

DIACROM SPATULA

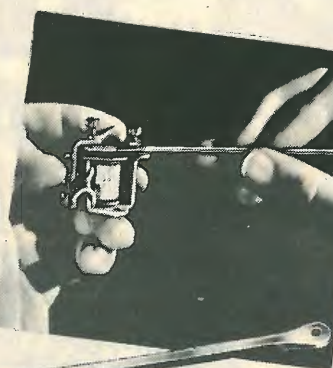

Manufactured in France
 British Patents applied for

No other cleaner has all these advantages:-

- Only 100% pure, natural diamond grains are utilised.
 - Blades are treated with hard chrome to reinforce the setting of the diamond grains, to obviate loosening or breakaway during use. This process also prevents clogging of the diamonded surface by residues resulting from use.
 - All diamonded blades are rectified to ensure an absolutely smooth surface by eliminating diamond grains which may rise above the surface. This eliminates all excessive scratching during use.
 - All diamond grains are rigidly calibrated to ensure a perfectly uniform grain size of either 200, 300 or 400.
 - The chrome gives a very weak co-efficient of friction and the rigidity of the nylon handle is calculated to permit proper utilisation and yet pliant enough to avoid undue pressures on highly delicate relays.
- Grain size 200, thickness 55/100 mm., both faces diamonded. For quick cleaning of industrial relays and switching equipment, etc.
 - Grain size 300, thickness 55/100mm., both faces diamonded. For smaller equipments, like telephone relays, computer relays, etc.
 - Grain size 400, thickness 25/100 mm., one face diamonded. For sensitive relays and tiny contacts. Two close contacts facing each other can be individually cleaned, because only one face of the spatula is abrasive.

Sole Distributors for the United Kingdom
SPECIAL PRODUCTS (DISTRIBUTORS) LTD
 81 Piccadilly, London W1V 0HL. Phone: 01-629 9556
 As supplied to the M.O.D., U.K.A.E.A., C.E.G.B. British Rail and other Public Authorities;
 also major industrial and electronic users throughout the United Kingdom.
 WW - 024 FOR FURTHER DETAILS

THE SOURCE OF ALL GOOD USED TEST EQUIPMENT

ANALYSERS

606-3 Line Disturbance Monitor	£2500.00
Hewlett Packard	
5004A Signature Analyser	£550.00
5420A Digital Signal Analyser	£21,000.00
8407A/8412A Network Analyser	£1800.00
Marconi	
TF2303 Mod Meter	£460.00
TF2337 Automatic Distortion Analyser	£250.00
Tektronix	
AA501 opt 01, Distortion 10Hz-100KHz to Less than 0.0025%	£1450.00
DAS 8103 opt 01 02, Logic Analyser	£11,000.00
DF1 Display Formatter For 7D01	£850.00
308 Portable 8 Channel 20MHz Data Analyser	£2100.00
491 Spectrum Analyser 10MHz-40GHz	£7500.00
492 (opt 01, 08) Spectrum Analyser 50KHz-220GHz	£13000.00
492P (opt 01, 2, 3) Programmable Version of 492	£20000.00
1401A Spectrum Analyser 1-500MHz	£950.00
7L5 Spectrum Analyser with opt 25 (Tracking Gen) and L3 (50K input) 20Hz-5MHz	£7300.00
7L12 Spectrum Analyser 100KHz-1.8GHz	£6000.00
7L13 Spectrum Analyser 1KHz-1.8GHz	£7500.00
7L14 Spectrum Analyser 10KHz-1.8GHz	£9450.00
7L18 Spectrum Analyser 1.5GHz-60GHz	£9950.00
TR502 Tracking Generator (for 7L12, 13 & 14)	£3200.00
TR503 Tracking Generator (for 492/496 series)	£3250.00
5L4N Spectrum Analyser 20Hz-100KHz	£2350.00
7D01 16 Channel 100MHz Sample Rate	£2450.00

TEKTRONIX TM500 SERIES

AF501 Bandpass Filter/Amplifier	£400.00
AM501 Op Amp Gain 10,000	£300.00
AM502 Diff. Amp Gain 1 - 100K	£500.00
DM502A True RMS 3 1/2 digit DMM	£325.00
DC503A 125MHz Counter	£475.00
DC505A 225MHz Counter	£600.00
DC509 Counter/Timer 135MHz	£950.00
FG501 Function Generator 0.001Hz-1MHz	£375.00
FG501A Function Generator 0.002Hz-2MHz	£450.00
FG502 Function Generator 0.1Hz-11MHz	£425.00
FG503 Function Generator 1Hz-3MHz	£275.00
PG501 50MHz Pulse Gen	£320.00
PG502 250MHz Pulse Gen	£1,450.00
PG505 Pulse Generator 1Hz-100KHz	£450.00
PG507 Pulse Gen 50MHz	£900.00
PG508 50MHz Pulse Gen	£1,250.00
SC502 15MHz Dual Trace Scope	£1000.00
SC504 80MHz Dual Trace Scope	£1250.00
SG503 Sinewave Generator 250KHz	£1,950.00
SG504 Sig Gen 1050MHz	£350.00
TM515 Mainframe (5 wide)	£350.00

We stock a complete range of Plug Ins for use with 7000 and 5000 series Mainframes.

TEKTRONIX PLUG INS

MISCELLANEOUS	
Bruel & Kjaer	
2209 Sound Level Meter	£850.00
Datalabs	
DL901 Transient Recorder	£750.00
DL905 Transient Recorder	£995.00
Ferroglyph	
RTS1 Test Set	£195.00
Fluke	
515A Portable Calibrator DC/AC and Resistance with DC Resolution 0.2uV	£1750.00
760A Meter Calibrator	£2950.00
883 AC/DC Differential	£615.00
845 AB Null Detector	£610.00
9315 Diff. V Meter	£1,000.00
2020A-4.6 Printer	£500.00
2020A-3.6 Printer	£500.00
3010A Logic Tester, Self Contained, Portable, Full Spec. on Request	£8500.00
Hewlett Packard	
3552A Trans Test Set	£1,500.00
3300B/5306A DMM/Counter	£1,200.00
5340A Counter 10Hz-18GHz 8 Digit	£3750.00
8013B Pulse Generator	£750.00
8350A/83525A Sweeper System	£9,500.00
8403A Modulator Fitted With B732B PIN MODULATOR	£1500.00
8745A S Parameter Test Set, Fitted with 11604A Universal Arms 0.1-2GHz	£2750.00
59308A HP-IB Timing Generator	£300.00
Marconi	
TF1313A LCR Bridge	£775.00
TF2603 RF Millivoltmeter	£750.00
Racal	
9301A RF Millivoltmeter	£495.00
Tektronix	
106 Square Wave Generator 1ns risetime 10Hz-1MHz without accessories	£175.00
577/D1 Curve Tracer	£3000.00
651HR PAL Monitor	£2,100.00
832 Data Comms. Tester	£925.00
833 Data Comms. Tester	£1350.00
2701 Step Attenuator 50Ω 0.79dB in 1dB steps DC to 2GHz	£295.00
2901 Time-Mark Generator	£195.00

Please note: Prices shown do not include VAT or carriage.

Electronic Brokers Ltd., 61/65 Kings Cross Road, London WC1X 9LN. Tel: 01-278 3461. Telex 298694

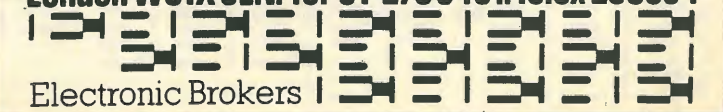

WW - 202 FOR FURTHER DETAILS

EuroCUBE 6502/6809

One small Eurocard - more computer than ever

EuroCUBE is just one, small 100x160mm Eurocard but it is an Industrial Computer of exceptional power and versatility.

The user has a choice of 6502 or 6809 microprocessors. Programs can be developed on a full CUBE development Eurorack or on any other microprocessor development system in a high level language such as Industrial BASIC or machine code.

EUROCUBE has four memory sockets whose function and position in memory is fully user selectable. For example, the first socket might contain a 4KB operating system EPROM, the second a BBC BASIC interpreter in ROM, the third the user's BASIC program in whatever size EPROM is convenient, and the fourth might contain 8KB of battery backed non-volatile CMOS RAM.

An on-board calendar clock is also supported by the battery, and provides the time of day to 1/10th second and the date correct for the whole century.

EUROCUBE communicates with the outside world through 20 digital i/o channels, RS423/RS232 serial port and the full CUBE/Acorn data bus through which the entire CUBE/Acorn range of video, disk, analog, solid state switches and other peripherals can be controlled.

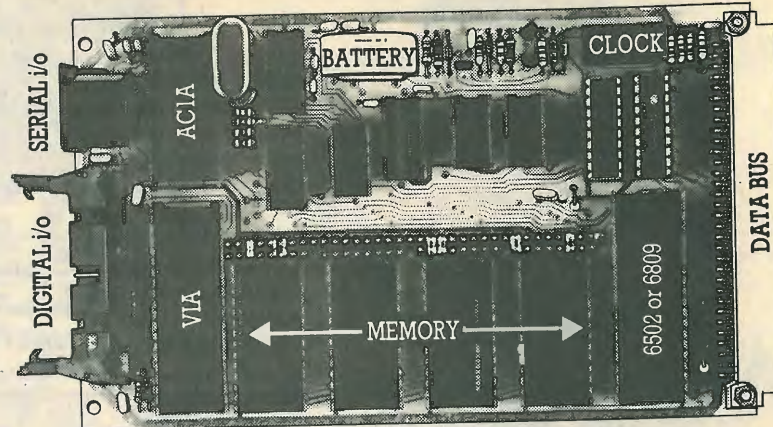

£139

Exc. VAT. No charge for Operating System Software

Control Universal's new 150 page catalogue and technical overview is now available free of charge. Use the reply service for your copy, or ring one of our engineering team to discuss your application.



Unit 2, Andersons Court,
Newnham Road, Cambridge CB3 9EZ
Telephone (0223) 358757

WW - 017 FOR FURTHER DETAILS

NEW! ICOM ICH2 SYNTHESIZED FM HANDPORTABLE



The ICH2 is the first of a new breed of synthesized hand-held radio transceivers. Being synthesized, it requires no crystals to be set on to frequency. All that is required is to lift a recessed panel on the top of the set and cut the correct diodes to program the set to one or two channels. Duplex or simplex is obtained in the same way. This really is a boon to the busy dealer and convenient for the customer who wants those extra few sets "yesterday".

The ICH2 is very versatile, coming complete with a rechargeable ni-cad pack, small mains charger, rubber helical antenna, earphone and strong spring belt clip. Optional extras include: A speaker/microphone, cigarette lighter plug 12V charging lead, 12V convertor to operate direct from the car supply, leather and leatherette cases, various different types of slide on/off battery packs both rechargeable and dry and a desk charger that fast charges some of the battery packs in 1 to 1 1/2 hours. The battery packs slide on and off very easily, enabling a spare to be carried in your pocket and an exchange made in the field. Sizes are 6.5"H x 2.6"W x 1.4"D, weighing 1.1lb. Power output is 1-3 watts and covers a frequency range of 164.975-174.975Mhz, duplex or simplex.

Retail price is 269 pounds each plus VAT. We are also looking for dealers for general distribution. More details from

Thanet Electronics **ICOM**

143 Reclver Road, Herne Bay, Kent
Tel: 02273 63859. Telex 965179

WW - 013 FOR FURTHER DETAILS

TO BE CRYSTAL CLEAR
Tel. 029-34-5353 Telex 87116 Aero G
MOD approved CAA approved

WW - 032 FOR FURTHER DETAILS

ELECTRON GUNS TV TUBE COMPONENTS

If you are Rebuilding or Manufacturing TV Tubes - We are the leading suppliers of Electron Guns and TV Tube Components to the TV Tube Industry. We specialise in all aspects of Electron Mount Technology. Our product range includes more than 250 gun types for Colour, In Line, Mono and Display Tubes along with Mount Parts, Bases, Getters, Sealoffs, and all other associated items for TV Tube Production. A Full Technical Back-up and Advisory Service is available to all customers Worldwide.

Please request our current catalogues and Data Information.

GRIFTRONIC EMISSION LTD
2 SWAN STREET
ALCESTER
WARWICKSHIRE
B49 5DP
ENGLAND

Telephone: (0789) 764852/764100. Telex: 312354 Grifem G

WW - 033 FOR FURTHER DETAILS

WIRELESS WORLD AUGUST 1983

Hilomast Ltd

HILOMAST SYSTEMS

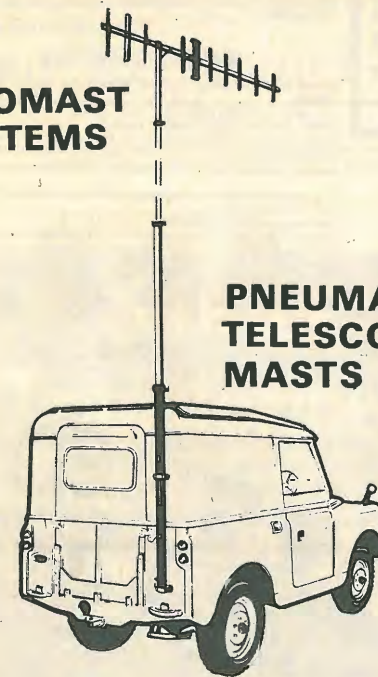

PNEUMATIC TELESCOPIC MASTS

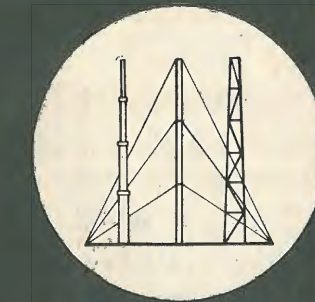

HILOMAST LIMITED

THE STREET HEYBRIDGE - MALDON
ESSEX CM9 7NB ENGLAND
Tel. MALDON (0621) 56480
TELEX NO. 995855

WW - 019 FOR FURTHER DETAILS

WIRELESS WORLD AUGUST 1983

DEC SALE

a selection from our huge stocks. All items reconditioned unless otherwise stated.

NEW AUTUMN '83 CATALOGUE now out send for your free copy

SPECIAL PURCHASE

OF PDP11/34A PROCESSORS
11/34A CPU
MS11JP 64KB MOS Memory
DL11W Console Interface
KY11LB Programmers Panel,
M9312 Bootstrap
BA11L 5 1/4" Chassis
ONLY £2,500

DEC PDP11/60

SYSTEMS special offer
11/60 Processor with 256KB
2 x RK06 Disk Drives + control
LA36 Console Rack Cabinet
OUR BARGAIN PRICE
£5250.00 All items
ex DEC-maintained site

PDP8A/RL01 SYSTEMS

special purchase - immaculate as new condition BA400-BR Processor complete with
KK8A CPU
MM8AB 16KW Core
KC8AA Programmers Panel
KM8AA Option module
DKC8A Option module
2 x RL01AK Disk Drive
RL8A Controller
H967 4ft. cabinet
£4750.00

DEC LSI PROCESSORS

11/03LX KD11HA CPU,
KEV11 EIS/FIS, BDV11AA Terminator/Bootstrap.
BA11N 5 1/4" Chassis with Backplane and Power Supply.
No memory included.
NEW £1200

11/03N KD11G CPU,
KEV11 EIS/FIS, BDV11AA Terminator/Bootstrap. BA11R 5 1/4" Chassis with Backplane and Power Supply, MSV11DD 32KW MOS

NEW £1495

DEC DISK DRIVES

RK07ED 28MB	£2,500
RK07PD 28MB	£2,500
RL01A 5MB	£995
RM02AD 67MB NEW	£6,250
RM03AD 67MB NEW	£6,250
RM05AD 256MB NEW	£14,750
RM80 124MB	£9,500
RPO6AB 176MB	£7,500
RX11BD Dual Floppy	£995
RX211BD Dual Floppy	£1,725

DEC PRINTERS AND TERMINALS

LA34 DECwriter IV EIA 300 baud	£425
LA36 DECwriter II 20mA	£295
LA36 DECwriter II RS232	£325
LA180-PD DECprinter (NEW)	£495
LS120 DECwriter III EIA 1200 baud	£750
VT50 DECscope 20mA	£199
VT50 DECscope RS232	£225
VT105 Graphics Terminal	£950
VT131AB	£995
VT132	£875

TEKTRONIX DESKTOP COMPUTERS

Special Purchase of Ex-Demonstrator Stock

4051

High resolution Graphics and Alphanumerics. 32KB Memory. Integral Cartridge Tape Drive
£2,250 INCLUDING OPTION 22 32KB MEMORY

4052

High performance stand-alone processor with 64KB Memory. Integral Cartridge Tape Drive
£4,950 INCLUDING OPTION 24 64KB MEMORY

JOYSTICK 4952

(for 4050 series) sensitive cursor-control with .1% accuracy and XY zero feature. **£275**

Other Tektronix graphics equipment currently available includes 4006-1, 4010-1, 4027, 4014-1, 4015-1, 4016-1, 606/606A/606B and 611

ADD 15% VAT TO ALL PRICES Carriage and Packing extra

Electronic Brokers Ltd., 61/65 Kings Cross Road, London WC1X 9LN. Tel: 01-278 3461. Telex 298694



Electronic Brokers

WW - 203 FOR FURTHER DETAILS

GET THE COMPLETE PICTURE

AT YOUR NEWSAGENT DURING JULY — OR DIRECT

— ORDER YOUR COPY NOW —

★ STILL THE ONLY CATALOGUE FOR THE COMPLETE RANGE OF COMPONENTS. BATTERIES, CRYSTAL FILTERS, RF POWER, MOSFET, TOKO COILS, CHOKES, ALPS PLOTTERS, SOLENOID CASSETTE MECHS ETC.

COMPONENTS FOR ELECTRONICS, COMMUNICATIONS & COMPUTING

ambit[®]
INTERNATIONAL

WORLD OF RADIO & ELECTRONICS
— CATALOGUE —



SUMMER '83

3 x £1 DISCOUNT VOUCHERS
144 PAGES
80p

- ★ FIRST WITH ON-LINE COMPUTER SHOPPING
- ★ FIRST FOR INNOVATION
- ★ FIRST FOR VALUE
- ★ FIRST FOR CHOICE
- ★ FIRST FOR SERVICE

ambit[®] INTERNATIONAL

200 North Service Road, Brentwood, Essex CM14 4SG
Tel: (Consumer Sales/Enquiries) 0277-230909.
Tel: (Industrial Sales/Enquiries) 0277-231616.
Tlx: 995194 AMBIT G. Data 24hrs (RS232/300 baud) 0277-232628.

WW - 039 FOR FURTHER DETAILS

CX80 COLOUR MATRIX PRINTER

New low price
£795 + V.A.T.

At last a low-cost Colour Matrix Printer for Text, Graphics, Histograms, Colour VDU Dumps, etc.

Colour printout is quickly assimilated, makes graphics more understandable and is an ideal medium for the presentation of complex data or concepts.

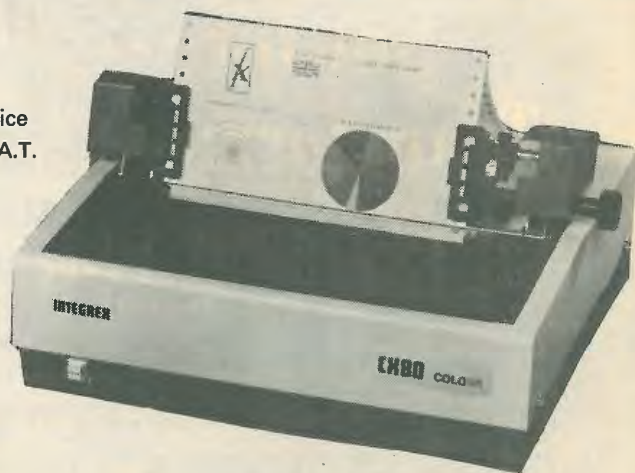

Compatible with most microprocessors, prints in 7 colours — sophisticated internal programme makes the CX80 easy to use.

Dot Addressable + 15 user programmable characters, 96 ASCII and 64 graphics characters in rom. Centronics interface with RS232 and IEEE488 options. Apple II interface gives dot for dot colour dump. New viewdata interface prints out two pages side by side in full colour. See Prestel 200650.

The CX80 is a product of our own design and development laboratories. It represents a British breakthrough in colour printer technology. Colour brochure on request. OEM pricing available.

INTEGREX LIMITED

Portwood Industrial Estate, Church Gresley
Burton-on-Trent, Staffs DE11 9PT
Burton-on-Trent (0283) 215432. Telex: 377106

Essex Tiny Basic System

The Essex Tiny Basic Computer is an ideal choice for data acquisition and process control systems. Its crystal controlled timer and interrupts provide accurate timing and fast response to critical events, while the watchdog timer ensures reliable operation. Programs can be entered and tested from an RS232 terminal, and then be copied into EPROM. Alternatively, Instant ROM modules may be used both during development and for program storage. INSTANT ROM is the trademark of Greenwich Instruments.

£185

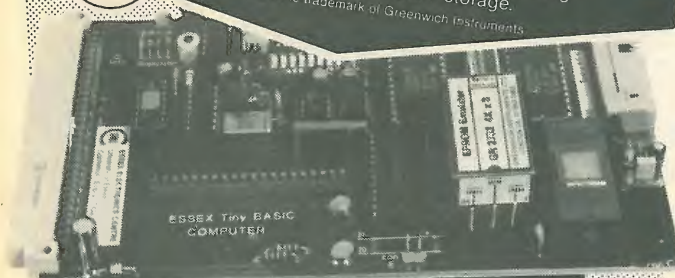

Essex Buffer Timer

A convenient means of buffering the I/O lines of the Essex Tiny BASIC Computer provides 24 inputs, 16 outputs and four hardware timers.

£78

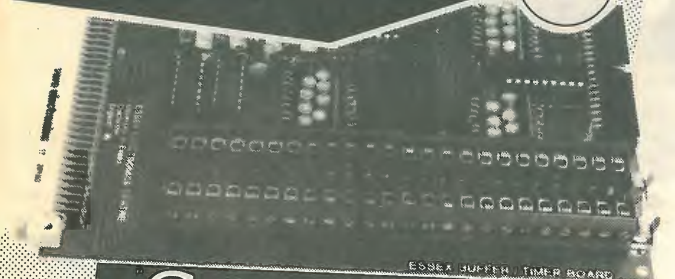

Essex Opto-Isolator

Connects to the Essex Tiny BASIC System bus to provide an additional 12 opto-isolated inputs and 12 opto-isolated outputs per card for safe connection to external equipment. Isolation voltage = 1500 volts.

£150

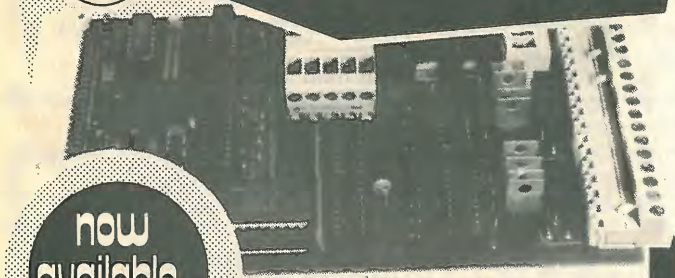

now available...

Essex Backplane

A four slot backplane with printer and terminal connectors to accept these cards. £35

Alex

A powerful software utilities package that provides the user with an enhanced editor and all the tools needed to program efficiently in assembly language.

- * Text Editor * Assembler
 - * Disassembler * Debug Monitor
- Supplied as a 4K EPROM with comprehensive manual. £65

Essex Electronics Centre

Wivenhoe Park, Colchester, Essex CO4 3SQ
Telephone: Colchester (0206) 865089

WW - 057 FOR FURTHER DETAILS

AUDIO ELECTRONICS

TEST EQUIPMENT CENTRES ALL MODELS ON DISPLAY OPEN SIX DAYS A WEEK

RETAIL • MAIL ORDER • EXPORT • INDUSTRIAL • EDUCATIONAL

DIGITAL MULTIMETERS (UK C/P Free) ALL MODELS 3 1/2 DIGIT UNLESS STATED

HAND HELD	With free carry case	Beckman T110 As T100 plus cont. test.	£67.85
KD25C=13 range 0.2A DC 2 meg ohm	£24.95	Sifam 2200B 21 range 2A AC/DC 20 meg ohm	£39.95
KD30C=16 range 10A AC/DC 2 meg ohm	£29.95	+Optional carry case £2.95	
KD55C=26 range 10A AC/DC 20 meg ohm	£39.95	BENCH MODELS	
6010= 28 range 10A AC/DC 20 meg ohm	£34.40	TM353= 27 range LCO 2A AC/DC	£86.25
7030= As 6010 but 0.1% basic.	£41.30	TM355= 29 range LEO 10A AC/DC	£86.25
KD615= 6 range 10A DC 2 meg plus Hfe tester	£39.95	TM351= 29 range LCO 10A AC/DC	£113.85
18SM 30 range 10A AC/DC 20 meg plus Hfe tester	£69.95	+Optional carry case £6.84	
HD30 16 range 0.2A AC/DC 2 meg ohm	£41.95	2001 28 range LCO 10A AC/DC plus 5 range Cap. Meter with case	£108.00
HD30/B As above plus cont. buzzer	£44.50	TM451 4 1/2 digit LCD every facility (0.02%)	£171.00
HD31 22 range 10 AC/DC 2 meg ohms plus cont. buzzer	£58.95	1503a 4 1/2 digit LCD every facility (0.05%)	£171.00
DM2350 = 21 range 10A AC/DC 20 meg ohm miniature hand held auto range	£49.95	1504a true RMS version	£201.25
Beckman T100 34 range 10A AC/DC 20 meg ohm	£56.35	Sifam 2500 24 range LCD 2A AC/DC	£99.95
		Metrix (ITT) professional 3 1/2 + 4 1/2 digit DMM's standard & true. RMS 4 models stocked	£77.00 - £201.25

FREQUENCY COUNTERS

PFM200A MHz hand held pocket 8 digit LED	£77.60	TM105 Various facilities 5 Hz - 5 MHz	£97.75
8110A 8 digit LED bench 2 ranges 100 MHz	£77.00	AUDIO: Multiband Sine/Square	
8610B 9 digit LED bench 2 ranges 600 MHz	£113.85	LAG27 10 Hz to 1 MHz	£90.85
8000B 9 digit LED 3 ranges 1 GHz	£178.00	AG202A 20 Hz to 200 KHz (List £94.50)	£83.50
TF040 = 8 digit LCD 40 MHz	£126.50	RS6402 100 KHz to 30 MHz (List £79.50)	£69.50
TF200 = 8 digit LCD 200 MHz	£166.75	LS617 100 KHz to 150 MHz	£79.35
+Optional carry case £6.84			
Prescalers - Extended range of most counters			
TP600 600 MHz	£43.00		
TP1000 1 GHz	£74.00		

ELECTRONIC INSULATION TESTER

YF 501 500 V/0-100m with carry case £63.00

MULTIMETERS (UK C/P 65p)

HM102Z 20K/V 10A DC 22 range & cont. buzzer	£13.50	HM103 15 MHz 2mV, 6 x 7 display plus component tester C/P £3.00	£181.70
HM102Z 20 K/V 22 range & cont buzzer	£14.95	+Optional carry case £6.84 AC adaptor £6.69	
ETC5000/5001 21 ranges, 50K/V. Range doubler, 10A DC.	£18.95	Nicads £12.50	
TMK500 23 ranges 30K/V, 12A DC plus cont. buzzer.	£24.75	DUAL TRACE (UK C/P £4.00)	
NH56R 20K/V, 22 range pocket	£10.95	DT 520 Dual 20 MHz	£241.50
ETU 102 14 range 2K/V pocket	£6.50	HM203/4 Dual 20 MHz plus component tester	£303.66
830A 26 range 30K/V, 10A AC/DC overload protection, etc.	£23.95	CS1562A Dual 10 MHz (List £321.00)	£269.50
360TR 23 range 100K/V. Large scale 10A AC/DC plus Hfe	£39.95	3131 Dual 15 MHz + component tester	£276.00
AT1020 18 range 20K/V. Deluxe plus Hfe tester	£18.95	CS1566A Dual 20 MHz All facilities (List £401.35)	£349.50
YN 360TR 19 range 20K/V plus Hfe tester	£15.95	HM204 Dual 20 MHz plus component tester sweep delay.	£419.75
Matrix Professional multimeters in stock 3 models from	£74.75	CS1820 Dual 20 MHz with extra facilities (List £508.30)	£485.00

VARIABLE POWER SUPPLIES (UK C/P £1.00)

PP241 0/12/24V, 0/1A	£35.00	OX710 Metrix dual 15 MHz + component tester	£304.75
PP243 3 amp version	£59.95	OPTIONAL PROBE KITS	
PS 1307S 8/15V 7 amp twin meter	£24.95	X1: £7.95 X1-X10 £10.50 X10 £9.45 X100 £16.95	

DIGITAL THERMOMETER

TH301 LCO -50°C to +750°C with thermocouple £68.43

AC CLAMP METER

ST300 0/300A: 0/600 VAC, 0/1 Kohm 9 ranges With carry case (UK C/P 65p) £28.50

LOGIC PROBES

LP10 10 MHz £28.50
DLP50 50 MHz with carry case and accessories £52.33

TRANSISTOR TESTER

Direct reading PNP: NPN, etc. TC1 (UK C/P 65p) £21.95

AUDIO ELECTRONICS

301 EDGWARE ROAD, LONDON W2 1BN, TEL: 01-724 3564
ALSO AT HENRY'S RADIO, 40A/406 EDGWARE ROAD, LONDON, W2, TEL: 01-724 0323
HENRY'S COMPONENT SHOP, TEL: 01-723 1008

WW - 016 FOR FURTHER DETAILS

NEW PRODUCT



The new microprocessor controlled EP8000 Emulator Programmer will program and emulate all EPROMs up to 8k x 8 sizes, and can be extended to program other devices such as 16k x 8 EPROMs, Bipolar PROMs, single chip microprocessors with external modules.

Personality cards and hardware changes are not required as the machine configures itself for the different devices.

The EP4000 with 4k x 8 static RAM is still available with EPROM programming and emulation capacity up to 4k x 8 sizes.

- EP8000 8k x 8 Emulator Programmer – £695 + £12 delivery
- BSC8 Buffered emulation cable – £49
- SA27128 Programming adaptor – £69
- SA25128 Programming adaptor – £69
- EP4000 4k x 8 Emulator Programmer – £545 + £12 de-

FEATURES

- Software personality programming/emulation of all EPROMs up to 8k x 8 bytes including 2704, 2708, 2716(3), 2508, 2758A, 2758B, 2516, 2716, 2532, 2732, 2732A, 68732-0, 68732-1, 68766, 68764, 2564, 2764. Programs 25128, 27128 with adaptors.
- No personality cards/characterisers required.
- Use as stand alone programmer, slave programmer, or EPROM development system.
- Checks for misplaced and reversed insertion, and shorts on data lines.
- Memory mapped video output allows full use of powerful editing facilities.
- Built-in LED display for field use.
- Powerful editing facilities include: Block/Byte move, insert, delete, match, highlight, etc.
- Comprehensive input/output – RS232C serial port, parallel port, cassette, printer O/P, DMA.
- Extra 1k x 8 scratchpad RAM for block moving.

- livery ● BSC4 Buffered emulation cable – £39
- BP4 (TEXAS) Bipolar PROM Module – £190
- Prinz video monitor – £99
- UV141 EPROM Eraser with timer – £78
- GP100A 80 column printer – £225
- GR1 Centronics interface – £65

VAT should be added to all prices

DISTRIBUTORS REQUIRED

EXPORT ENQUIRIES WELCOME

GP Industrial Electronics Ltd.

Tel: Plymouth (0752) 332961
Telex: 42513

Unit E, Huxley Close, Newnham Industrial Estate, Plymouth PL7 4JN

WW – 025 FOR FURTHER DETAILS



NEW PRODUCT

- Checks, Programs, Compares up to 8 devices simultaneously
- Handles all NMOS EPROMS up to projected 128K designs with no personality modules or characterisers – See list
- Easy to use, menu driven operation for blankcheck, program, verify, illegal bit check, checksum, self-test
- Constant display of device type, mode and fault codings
- Individual socket LED indicators for EPROM status
- Comprehensive EPROM integrity checks – Illegal bit check, data and address shorts, constant power line monitoring
- Full safeguard protection on all sockets
- Automatic machine self-test routine
- RS232C interface supplied as standard
- Powered down sockets
- Cost effective price – £695 + VAT
- Available from stock

Write or phone for more details

DISTRIBUTORS REQUIRED

EXPORT ENQUIRIES WELCOME

GP Industrial Electronics Ltd.

Tel: Plymouth (0752) 332961
Telex: 42513

Unit E, Huxley Close, Newnham Industrial Estate, Plymouth PL7 4JN

WW – 025 FOR FURTHER DETAILS

- 2704
- 2708
- 2716(3)
- 2508
- 2758A
- 2758B
- 2516
- 2716
- 48016
- 2532
- 2732
- 2732A
- 68732-0
- 68732-1
- 68766
- 68764
- 2764
- 2564
- MK2764
- 25128
- 27128

TOROIDALS

The toroidal transformer is now accepted as the standard in industry, overtaking the obsolete laminated type. Industry has been quick to recognise the advantages toroidals offer in size, weight, lower radiated field and, thanks to I.L.P., PRICE.

Our large standard range is complemented by our SPECIAL DESIGN section which can offer a prototype service within 7 DAYS together with a short lead time on quantity orders which can be programmed to your requirements with no price penalty.

*Gold service available.
21 days manufacture for urgent deliveries.

*Orders despatched within 7 days of receipt for single or small quantity orders.

*5 year no quibble guarantee.

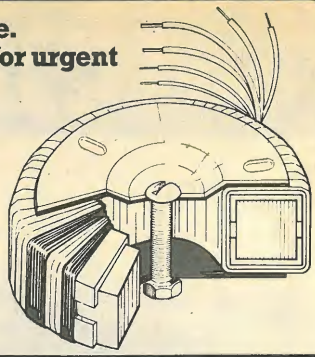

TYPE	SERIES	SECONDARY	RMS	PRICE	TYPE	SERIES	SECONDARY	RMS	PRICE	TYPE	SERIES	SECONDARY	RMS	PRICE					
	No	Volts	Current			No	Volts	Current			No	Volts	Current						
<p>NEW! NEW! NEW!</p>																			
<p>15 VA 0x010 6+6 1.25 62 x 34mm 0x011 9+9 0.83 0.35Kg 0x012 12+12 0.63 Regulation 0x013 15+15 0.50 19% 0x014 18+18 0.42 0x015 22+22 0.34 0x016 25+25 0.30 0x017 30+30 0.25</p> <p>£5.12 + p & p £0.78 + VAT £0.89 TOTAL £6.79</p> <p>(encased in ABS plastic)</p>					<p>120 VA 4x010 6+6 10.00 90 x 40mm 4x011 9+9 6.66 1.2Kg 4x012 12+12 5.00 Regulation 4x013 15+15 4.00 11% 4x014 18+18 3.33 4x015 22+22 2.72 4x016 25+25 2.40 4x017 30+30 2.00 4x018 35+35 1.71 4x028 110 1.09 4x029 220 0.54 4x030 240 0.50</p> <p>£7.42 + p & p £1.72 + VAT £1.37 TOTAL £10.51</p>					<p>300 VA 7x013 15+15 10.00 110 x 50mm 7x014 18+18 8.33 2.6Kg 7x015 22+22 6.82 Regulation 7x016 25+25 6.00 6% 7x017 30+30 5.00 7x018 35+35 4.28 7x026 40+40 3.75 7x025 45+45 3.33 7x033 50+50 3.00 7x028 110 2.72 7x029 220 1.36 7x030 240 1.25</p> <p>£10.88 + p & p £2.05 + VAT £1.94 TOTAL £14.87</p>									
<p>30 VA 1x010 6+6 2.50 70 x 30mm 1x011 9+9 1.66 0.45Kg 1x012 12+12 1.25 Regulation 1x013 15+15 1.00 18% 1x014 18+18 0.83 1x015 22+22 0.68 1x016 25+25 0.60 1x017 30+30 0.50</p> <p>£5.49 + p & p £1.10 + VAT £0.99 TOTAL £7.58</p>					<p>160 VA 5x011 9+9 8.89 110 x 40mm 5x012 12+12 6.66 1.9Kg 5x013 15+15 5.33 Regulation 5x014 18+18 4.44 8% 5x015 22+22 3.63 5x016 25+25 3.20 5x017 30+30 2.66 5x018 35+35 2.28 5x028 110 1.45 5x029 220 0.72 5x030 240 0.66</p> <p>£8.43 + p & p £1.72 + VAT £1.52 TOTAL £11.67</p>					<p>500 VA 8x016 25+25 10.00 140 x 60mm 8x017 30+30 8.33 4Kg 8x018 35+35 7.14 Regulation 8x026 40+40 6.25 4% 8x025 45+45 5.55 8x033 50+50 5.00 8x042 55+55 4.54 8x028 110 4.54 8x029 220 2.27 8x030 240 2.08</p> <p>£14.38 + p & p £2.40 + VAT £2.40 TOTAL £19.30</p>									
<p>50 VA 2x010 6+6 4.16 80 x 35mm 2x011 9+9 2.77 0.9Kg 2x012 12+12 2.08 Regulation 2x013 15+15 1.66 13% 2x014 18+18 1.38 2x015 22+22 1.13 2x016 25+25 1.00 2x017 30+30 0.83 2x028 110 0.45 2x029 220 0.22 2x030 240 0.20</p> <p>£6.13 + p & p £1.35 + VAT £1.12 TOTAL £8.60</p>					<p>625 VA 9x017 30+30 10.41 140 x 75mm 9x018 35+35 8.92 5Kg 9x026 40+40 7.81 Regulation 9x025 45+45 6.94 4% 9x033 50+50 6.25 9x042 55+55 5.68 9x028 110 5.68 9x029 220 2.84 9x030 240 2.60</p> <p>£17.12 + p & p £2.05 + VAT £2.95 TOTAL £22.62</p>					<p>225 VA 6x012 12+12 9.38 110 x 45mm 6x013 15+15 7.50 2.2Kg 6x014 18+18 6.25 Regulation 6x015 22+22 5.11 7% 6x016 25+25 4.50 6x017 30+30 3.75 6x018 35+35 3.21 6x026 40+40 2.81 6x025 45+45 2.50 6x033 50+50 2.25 6x028 110 2.04 6x029 220 1.02 6x030 240 0.93</p> <p>£9.81 + p & p £2.05 + VAT £1.74 TOTAL £13.64</p>									
<p>80 VA 3x010 6+6 6.64 90 x 30mm 3x011 9+9 4.44 1Kg 3x012 12+12 3.33 Regulation 3x013 15+15 2.66 12% 3x014 18+18 2.22 3x015 22+22 1.81 3x016 25+25 1.60 3x017 30+30 1.33 3x028 110 0.72 3x029 220 0.36 3x030 240 0.33</p> <p>£6.66 + p & p £1.72 + VAT £1.26 TOTAL £9.64</p>					<p>ALSO AVAILABLE Sizes up to and including 5KVA are manufactured to order.</p>														

The benefits of ILP toroidal transformers
ILP toroidal transformers are only half the weight and height of their laminated equivalents, and are available with 110V, 220V or 240V primaries coded as follows:
IMPORTANT: Regulation — All voltages quoted are FULL LOAD. Please add regulation figure to secondary voltage to obtain full load voltage.
For 110V primary insert "0" in place of "X" in type number.
For 220V primary (Europe) insert "1" in place of "X" in type number.
For 240V primary (UK) insert "2" in place of "X" in type number.
Also available at Electrovalve, Maplin, Technomatic and Barrie Electronics.

For mail order please make your crossed cheques or postal orders payable to ILP Electronics Ltd. Barclaycard/Access welcome. Trade orders standard terms.
Post to: ILP Electronics Ltd, Graham Bell House, Roper Close, Canterbury CT2 7EP, Kent, England.
Telephone (0227) 54778 Telex 965780.



WW - 006 FOR FURTHER DETAILS

Hitachi Oscilloscopes

performance, reliability, value

New Models!

immediate delivery!

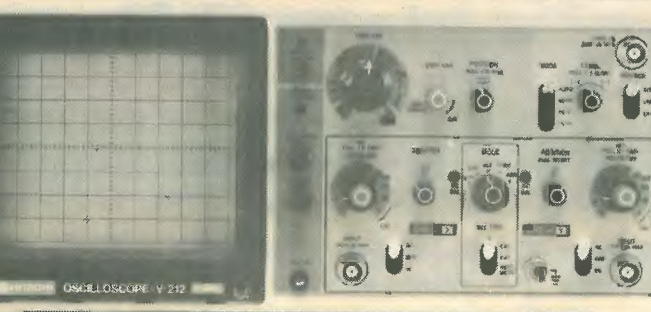

New from Hitachi are three low-cost bench scopes with bigger screens and extra features in a new slimline ultra-lightweight format. The range now extends to 13 models:—

- 4 dual trace single timebase models 20MHz to 40MHz
- 2 dual trace sweep delay models 20MHz and 35MHz
- 2 dual timebase multi-trace models 60MHz and 100MHz
- 2 miniature field portable models, 20MHz and 50MHz
- 3 storage models, one tube storage, two digital storage

Prices start at £295 plus vat (model illustrated) including 2 probes and a 2-year warranty. We hold the range in stock for immediate delivery.

For colour brochure giving specifications and prices ring (0480) 63570.

Reltech Instruments, 46 High Street, Solihull, W. Midlands, B91 3TB

WW - 052 FOR FURTHER DETAILS

LANGREX SUPPLIES LTD

Climax House, Fallsbrook Rd., Streatham, London SW16 6ED
Tel: 01-677 2424 Telex: 946708

RST RST

SEMICONDUCTORS				VALVES				INTEGRATED CIRCUITS													
TYPE	SERIES	SECONDARY	RMS	TYPE	SERIES	SECONDARY	RMS	TYPE	SERIES	SECONDARY	RMS	TYPE	SERIES	SECONDARY	RMS						
	No	Volts	Current		No	Volts	Current		No	Volts	Current		No	Volts	Current						
AA119	0.10	AS215	1.20	BC173	0.11	BD132	0.48	BF257	0.27	GEX541	5.00	OA207	1.50	OC205	2.75	ZTX504	0.21	2N1671	5.00	2N3819	0.30
AA199	0.17	AS216	1.10	BC177	0.28	BD136	0.40	BF259	0.27	GJ3M	1.50	OC20	2.50	OC206	2.50	ZTX550	0.24	2N1893	0.32	2N3820	0.39
AA230	0.17	AS217	1.00	BC178	0.28	BD137	0.40	BF336	0.34	KJ100A	0.45	OC22	2.50	OC207	2.50	IN914	0.25	2N2147	4.00	2N3823	1.60
AA213	0.15	AS220	2.30	BC179	0.28	BD138	0.40	BF338	0.36	MJ300	0.60	OC23	2.50	OC208	2.50	IN915	0.05	2N2148	3.75	2N3826	1.00
AA217	0.15	AS221	2.50	BC182	0.11	BD139	0.48	BF321	4.00	MJ371	0.71	OC25	1.00	R2009	2.25	IN4001	0.06	2N2218	0.32	2N3900	0.17
AC107	0.55	AU113	2.50	BC183	0.11	BD140	0.58	BF528	2.25	MJ520	0.47	OC26	1.50	R2010B	2.25	IN4002	0.06	2N2220	0.20	2N3906	0.17
AC125	0.25	BA145	3.00	BC184	0.11	BD144	2.00	BF561	0.20	MJ521	0.73	OC28	2.00	TIC44	0.27	IN4003	0.06	2N2221	0.20	2N4058	0.20
AC126	0.25	BA148	1.15	BC213	0.11	BD181	0.80	BF570	0.10	MJ522	0.73	OC29	2.00	TIC45	0.12	IN4005	0.09	2N2222	0.20	2N4059	0.20
AC127	0.25	BA154	0.10	BC214	0.11	BD2137	0.54	BFW10	0.97	MJ535	1.10	OC35	1.50	TIL209	0.16	IN4006	0.11	2N2233	4.25	2N4060	0.16
AC128	0.30	BA155	0.11	BC237	0.11	BD238	0.54	BFW11	0.96	MJ535	1.10	OC36	1.50	TIP29A	0.43	IN4007	0.12	2N2238	0.25	2N4061	0.16
AC141	0.28	BA156	0.10	BC238	0.11	BD239	0.54	BFW12	0.96	MJ535	1.10	OC37	1.50	TIP30A	0.43	IN4008	0.07	2N2484	0.25	2N4124	0.16
AC141K	0.35	BA157	0.13	BC239	0.11	BD240	0.91	BFX84	0.30	MJ535	1.10	OC38	1.50	TIP31A	0.43	IN4009	0.07	2N2485	0.25	2N4126	0.16
AC142	0.28	BA158	0.13	BC303	0.33	BDX32	2.00	BFX87	0.30	MJ535	1.10	OC39	1.50	TIP32A	0.36	IN4010	0.07	2N2486	0.25	2N4128	0.16
AC142K	0.35	BA160	0.06	BC307	0.11	BDY60	2.75	BFY50	0.25	MPSA06	0.26	OC44	0.85	TIP33A	0.36	IN4011	0.07	2N2487	0.25	2N4130	0.16
AC176	0.30	BC107	0.16	BC308	0.11	BF115	0.35	BFY51	0.25	MPSA06	0.26	OC45	0.85	TIP34A	0.47	IS44	0.04	2N2488	0.21	2N4131	0.16
AC187	0.28	BC108	0.16	BC327	0.12	BF152	0.16	BFY52	0.25	MPSU01	0.53	OC47	0.65	TIP41A	0.44	IS44	0.04	2N2489	0.21	2N4132	0.16
AC188	0.28	BC109	0.16	BC328	0.12	BF153	0.16	BFY53	0.25	MPSU01	0.53	OC48	0.65	TIP41A	0.44	IS44	0.04	2N2490	0.21	2N4133	0.16
AC189	0.28	BC110	0.16	BC337	0.12	BF154	0.17	BFY54	0.25	MPSU01	0.53	OC49	0.65	TIP41A	0.44	IS44	0.04	2N2491	0.21	2N4134	0.16
AC191	1.10	BC114	0.15	BC338	0.12	BF159	0.17	BSX19	0.27	NKT401	3.50	OC75	0.65	TIS43	0.43	ZG306	1.00	2N3053	0.26	2N5458	0.32
AC192	1.10	BC115	0.15	BCY30	1.25	BF160	0.17	BSX20	0.27	NKT403	2.50	OC76	1.00	ZS140	0.25	2N404	1.30	2N3054	0.26	2N5459	0.32
AC193	1.10	BC116	0.15	BCY31	1.50	BF161	0.24	BSX21	0.27	NKT404	2.20	OC77	1.00	ZS170	0.25	2N405	1.30	2N3055	0.26	2N5460	0.32
AC194	1.10	BC117	0.15	BCY32	1.50	BF162	0.24	BSX22	0.27	NKT404	2.20	OC78	1.00	ZS171	0.25	2N406	1.30	2N3056	0.26	2N5461	0.32
AC195	1.10	BC118	0.18	BCY33	1.50	BF163	0.24	BSX23	0.27	NKT404	2.20	OC79	1.00	ZS172	0.25	2N407	1.30	2N3057	0.26	2N5462	0.32
AD149	0.75	BC125	0.18	BCY34	1.00	BF178	0.35	BU205	1.30	OA10	0.55	OC82	0.90	ZS278	0.57	2N705	1.25	2N3442	1.25	2S103	1.50
AD162	0.35	BC135	0.15	BCY39	3.40	BF179	0.35	BU206	1.50	OA27	0.12	OC83	0.90	ZS279	0.57	2N706	1.25	2N3443	1.25	2S104	1.50
AF106	0.35	BC136	0.15	BCY42	0.30	BF180	0.28	BU207	1.50	OA27	0.12	OC84	0.90	ZS280	0.57	2N707	1.25	2N3444	1.25	2S105	1.50
AF115	0.75	BC137	0.19	BCY43	0.30	BF181	0.28	BU208	1.50	OA27	0.12	OC85	0.90	ZS281	0.57	2N708	1.25	2N3445	1.25	2S106	1.50
AF116	0.75	BC147	0.12	BCY58	0.17	BF183	0.28	BU209	1.50	OA27	0.12	OC86	0.90	ZS282	0.57	2N709	1.25	2N3446	1.25	2S107	1.50
AF117	0.75	BC148	0.12	BCY70	0.17	BF184	0.28	BU210	1.50	OA27	0.12	OC87	0.90	ZS283	0.57	2N710	1.25	2N3447	1.25	2S108	1.50
AF139	0.33	BC157	0.13	BCY71	0.18	BF185	0.28	BU211	1.50	OA27	0.12	OC88	0.90	ZS284	0.57	2N711	1.25	2N3448	1.25	2S109	1.50
AF231	0.39	BC159	0.13	BD115	0.42	BF196	0.14	BU212	1.50	OA27	0.12	OC89	0.90	ZS285	0.57	2N712	1.25	2N3449	1.25	2S110	1.50
AFZ12	4.00	BC170	0.11	BD121	1.70	BF197	0.13	BU213	1.50	OA27	0.12	OC90	0.90	ZS286	0.57	2N713	1.25	2N3450	1.25	2S111	1.50
AS226	1.40</																				

Accurate Digital Multimeters at Exceptional Prices

NEW ANALOGUE METER WITH CONTINUITY BUZZER AND BATTERY SCALE

28 RANGES, EACH WITH FULL OVERLOAD PROTECTION

SPECIFICATION MODELS 6010 & 7030

- 10 amp AC/DC
- Battery: Single 9V drycell. Life: 200 hrs
- Dimensions: 170 x 89 x 38mm.
- Weight: 400g inc. battery.
- Mode Select: Push Button.
- AC DC Current: 200µA to 10A
- AC Voltage: 200mV to 750V
- DC Voltage: 200mV to 1000V
- Resistance: 200Ω to 20MΩ
- Input Impedance: 10MΩ
- Display: 3 1/2 Digit 13mm LCD
- O/Load Protection: All ranges

OTHER FEATURES: Auto polarity, auto zero, battery low indicator, ABS plastic case with tilt stand, battery and test leads included, optional carrying case.

Quantity discount for trade on application.



6010
.5% Accuracy
£29.95

7030
.1% Accuracy
£35.95

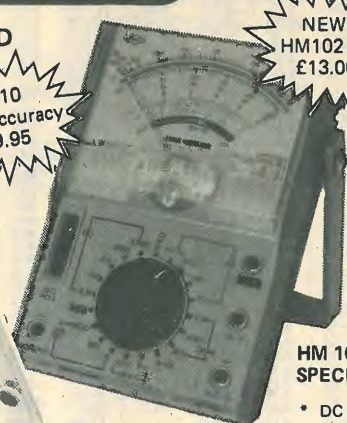

NEW HM102 BZ
£13.00

NEW HM 102 BZ SPECIFICATION

- DC Voltage: 0-25, 1, 2.5, 10, 25, 100, 250, 1000 volts 20,000 ohms/volt.
- AC Voltage: 0-10, 25, 100, 250, 1000 volts 10,000 ohms/volt.
- Decibels: -20 to +22dB
- DC Current: 0-50, 500µA, 0-5, 50, 500mA
- Ohmmeter: 0-6 Megohms in 4 ranges. 30 ohms Centre Scale
- Power Supply: One 1.5V size 'A' battery (incl)
- Size & Weight: 135 x 91 x 39mm, 280gr.

HM 101 POCKET SIZE MULTIMETER SPECIFICATION

- DC & AC Voltage: 0-10, 50, 250, 1000 volts, 2000 ohms/volts
- Decibels: -10 to +22dB
- DC Current: 0-100mA
- Ohmmeter: 0-1 Megohm in 2 ranges, 60 ohms Centre Scale
- Power Supply: One 1.5V size 'A' battery (incl)
- Size & Weight: 90 x 60 x 29mm, 92gr. incl. battery
- Price: £5.50

Add 15% to your order for VAT. P&P is free of charge.

Payment by cheque with order



ARON ELECTRONICS LTD.

Cottrell House, 53-63 Wembley Hill Road, Wembley, Middlesex HA9 8BH, England

Telephone: 01-902 4321 (3 lines)

TELEX No. 923985



accepted

WW - 007 FOR FURTHER DETAILS

Toroidal Transformers

THE COTSWOLD "BUDGET RANGE" OFFERS BUILT-IN QUALITY COUPLED TO A RELIABLE DELIVERY SERVICE MOST TYPES FROM STOCK

IEC 65
VDE 0550
BS 415
TO ORDER

PHONE
TELEX, WRITE
FOR DATA SHEET
AND PRICE LIST

Cotswold Electronics LTD.

Unit T1, Kingsville Road, Kingsditch Trading Estate, Cheltenham GL51 9NX

Tel: 0242-41313

Telex: 897106

Sales Office in U.S.A.
AVEL LINDBERG INC.
Peacock Alley 116, 1 Padanaram Road, Danbury, CT 06810 U.S.A.
203-797-8698. Telex: 710-456-9984

WW - 012 FOR FURTHER DETAILS

STEREO DISC AMPLIFIER 4

THE MOST THOROUGHLY RESEARCHED DISC AMPLIFIER THERE IS for Broadcasting, Disc Monitoring and Transfer



Supersedes Stereo Disc Amplifier 2. Unique Response Variable Filter which provides, through a single control knob, a 3dB turnover frequency variable between 13 and 4kHz but always with an appropriate phase and amplitude characteristic for psychoacoustic considerations. Ring or write for full specifications:

SURREY ELECTRONICS LTD., The Forge, Lucks Green, Cranleigh Surrey, GU6 7BG - Telephone: 0483 275997

METAL FILM RESISTORS

100R	1k	10k	100k
110R	1k1	11k	110k
120R	1k2	12k	120k
130R	1k3	13k	130k
150R	1k5	15k	150k
160R	1k6	16k	160k
180R	1k8	18k	180k
200R	2k	20k	200k
220R	2k2	22k	220k
240R	2k4	24k	240k
270R	2k7	27k	270k
300R	3k	30k	-
330R	3k3	33k	330k
360R	3k6	36k	-
390R	3k9	39k	-
430R	4k3	43k	-
470R	4k7	47k	470k
510R	5k1	51k	-
560R	5k6	56k	560k
620R	6k2	62k	-
680R	6k8	68k	680k
750R	7k5	75k	-
820R	8k2	82k	820k
910R	9k1	91k	1M

1/4 Watt, 1% tolerance, 3p each. 89 Values, E24, see left. Minimum order £20. Minimum 10 pcs per value. VAT, P&P incl.

SPECIAL OFFER
10 pcs of each value, 890 pcs
£25.30

SPECIAL 'POP' PACK
100 pcs: 100R, 1K, 4K7, 10K, 47K,
100K, 1M. 50 pcs: 330R, 470R, 1K5,
2K2, 3K3, 22K. Total 1000 pcs. £28.50.

One of each pack £50 only

ORION SCIENTIFIC LTD - 16 Orange Street - London WC2H 7ED

WW - 047 FOR FURTHER DETAILS

Versatower:

A range of telescopic towers in static and mobile models from 7.5 to 36 metres with tilt-over facility enabling all maintenance to be at ground level.



Designed in accordance with CP3 Chapter V: part 2: 1972 for a minimum wind speed of 85 mph in conditions of maximum exposure and specified by professionals world-wide where hostile environments demand the ultimate in design, quality and reliability.

Suitable for mounting equipment in the fields of:

- Communications
- Security surveillance - CCTV
- Meteorology
- Environmental monitoring
- Geographical survey
- Defence range-finding
- Marine & aero navigation
- Floodlighting
- Airport approach lighting

Further details available on request.



Strumtech Engineering Limited,
Portland House, Coppice Side,
Brownhills, Walsall, West Midlands,
WS8 7EX, England.
Telephone: Brownhills (05433) 4321.
Telex: 335243 SEL G.

WW - 020 FOR FURTHER DETAILS

hi! performance hi! competitive hi!

MORE people are buying TRIO

*** FOR ***

MORE DISPLAY

nearly 50% more with the NEW LARGE 6 inch rectangular CRT with illuminated inner face graticule, 6KV accelerator voltage for a brighter, higher resolution display with guaranteed accuracy.

MORE SENSITIVITY

1 milli Volt per cm in the vertical axis, valuable for observing complex low level waveforms especially with 20 nano sec per cm Sweep Speed.

MORE FACILITIES

like push-button MODES inc. Add, Sub, Alt and Chop - V mode trigger SOURCE - NEW super video sync - Front panel control of Astig, Trace rotation, Scale illum and X-Y - Chan I O/P, Int. Mod etc, etc.

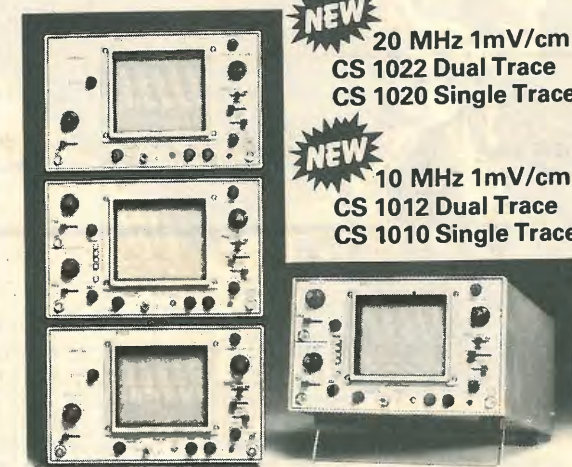

NEW
20 MHz 1mV/cm
CS 1022 Dual Trace
CS 1020 Single Trace

NEW
10 MHz 1mV/cm
CS 1012 Dual Trace
CS 1010 Single Trace

AT REAL VALUE FOR MONEY PRICES

Fully Guaranteed for 2 years inc.
Free 'pick up' and 'return'



In a hurry? Then ring (0799) 24922

House of Instruments,
Clifton Chambers, 62 High Street,
Saffron Walden, Essex CB10 1EE.
Telephone: (0799) 24922 Telex: 818750

Ask for FREE DATA

TRIO

hi!

hi! competitive hi! House of Instruments Ltd.

WW - 028 FOR FURTHER DETAILS

GET BIG POWER

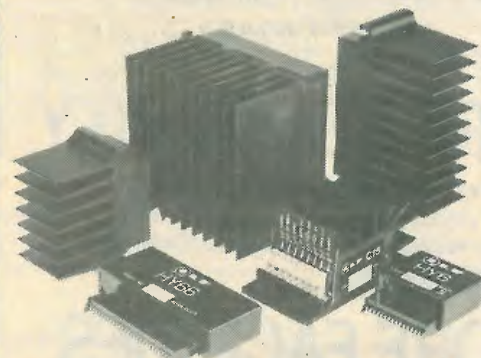

ILP Modular Amplifiers the third generation

Due to continuous improvements in components and design ILP now launch the largest and most advanced generation of modules ever.

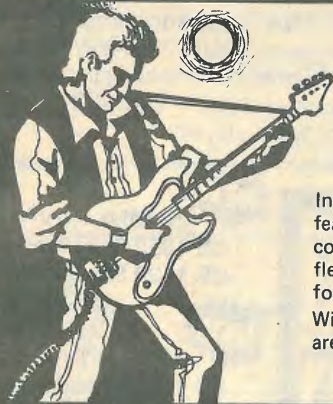

WE'RE INSTRUMENTAL IN MAKING A LOT OF POWER

In keeping with ILP's tradition of entirely self-contained modules featuring, integral heatsinks, no external components and only 5 connections required, the range has been optimized for efficiency, flexibility, reliability, easy usage, outstanding performance, value for money.

With over 10 years experience in audio amplifier technology ILP are recognised as world leaders.



BIPOLAR MODULES								
Module Number	Output Power Watts rms	Load Impedance Ω	DISTORTION T.H.D. Typ at 60Hz/1KHz	I.M.D. 7KHz 4:1	Supply Voltage Typ	Size mm	WT gms	Price inc. VAT
HY30	15	4-8	<0.006%	± 18	76 x 68 x 40	240	£8.40	
HY40	30	4-8	<0.006%	± 25	76 x 68 x 40	240	£9.55	
HY60	30 + 30	4-8	<0.006%	± 25	120 x 78 x 40	420	£18.69	
HY124	60	4	<0.006%	± 26	120 x 78 x 40	410	£20.75	
HY128	60	8	<0.006%	± 35	120 x 78 x 40	410	£20.75	
HY244	120	4	<0.006%	± 35	120 x 78 x 50	520	£25.47	
HY248	120	8	<0.006%	± 50	120 x 78 x 50	520	£25.47	
HY364	180	4	<0.006%	± 45	120 x 78 x 100	1030	£38.41	
HY368	180	8	<0.006%	± 60	120 x 78 x 100	1030	£38.41	

Protection: Full load line. Slew Rate: 15v/ μ s. Rise time: 5 μ s. S/N ratio: 100db. Frequency response (-3dB) 15Hz - 50KHz. Input sensitivity: 500mV rms. Input impedance: 100K Ω . Damping factor: 100Hz > 400.

PRE-AMP SYSTEMS				
Module Number	Module	Functions	Current Required	Price inc. VAT
HY6	Mono pre amp	Mic/Mag, Cartridge/Tuner/Tape/Aux + Vol/Bass/Treble	10mA	£7.60
HY66	Stereo pre amp	Mic/Mag, Cartridge/Tuner/Tape/Aux + Vol/Bass/Treble/Balance	20mA	£14.32
HY73	Guitar pre amp	Two Guitar (Bass Lead) and Mic + separate Volume Bass Treble + Mix	20mA	£15.36
HY78	Stereo pre amp	As HY66 less tone controls	20mA	£14.20

Most pre-amp modules can be driven by the PSU driving the main power amp. A separate PSU 30 is available purely for pre amp modules if required for £5.47 (inc. VAT). Pre-amp and mixing modules in 18 different variations. Please send for details.

Mounting Boards
For ease of construction we recommend the B6 for modules HY6-HY13 £1.05 (inc. VAT) and the B66 for modules HY66-HY78 £1.29 (inc. VAT).

POWER SUPPLY UNITS (Incorporating our own toroidal transformers)

Model Number	For Use With	Price inc. VAT	Model Number	For Use With	Price inc. VAT	Model Number	For Use With	Price inc. VAT
PSU 21X	1 or 2 HY30	£11.93	PSU 52X	2 x HY124	£17.07	PSU 72X	2 x HY248	£22.54
PSU 41X	1 or 2 HY60, 1 x HY6060, 1 x HY124	£13.83	PSU 53X	2 x MOS128	£17.86	PSU 73X	1 x HY364	£22.54
PSU 42X	1 x HY128	£15.90	PSU 54X	1 x HY248	£17.86	PSU 74X	1 x HY368	£24.20
PSU 43X	1 x MOS128	£16.70	PSU 55X	1 x MOS248	£19.52	PSU 75X	2 x MOS248, 1 x MOS368	£24.20
PSU 51X	2 x HY128, 1 x HY244	£17.07	PSU 71X	2 x HY244	£21.75			

Please note: X in part no. indicates primary voltage. Please insert "0" in place of X for 110V, "1" in place of X for 220V, and "2" in place of X for 240V.

MOSFET MODULES								
Module Number	Output Power Watts rms	Load Impedance Ω	DISTORTION T.H.D. Typ at 1KHz	I.M.D. 7KHz 4:1	Supply Voltage Typ	Size mm	WT gms	Price inc. VAT
MOS 128	60	4-8	<0.005%	<0.006%	± 45	120 x 78 x 40	420	£30.41
MOS 248	120	4-8	<0.005%	<0.006%	± 55	120 x 78 x 80	850	£39.86
MOS 364	180	4	<0.005%	<0.006%	± 55	120 x 78 x 100	1025	£45.51

Protection: Able to cope with complex loads without the need for very special protection circuitry (fuses will suffice). Slew rate: 20v/ μ s. Rise time: 3 μ s. S/N ratio: 100db. Frequency response (-3dB): 15Hz - 100KHz. Input sensitivity: 500mV rms. Input impedance: 100K Ω . Damping factor: 100Hz > 400.

'NEW to ILP' In Car Entertainments

C15
Mono Power Booster Amplifier to increase the output of your existing car radio or cassette player to a nominal 15 watts rms.

Very easy to use. £9.14 (inc. VAT)

Robust construction. Mounts anywhere in car. Automatic switch on. Output power maximum 22w peak into 4 Ω .

Frequency response (-3dB) 15Hz to 30KHz. T.H.D. 0.1% at 10w-1KHz. S/N ratio (DIN AUDIO) 80dB. Load Impedance 3 Ω . Input Sensitivity and Impedance (selectable) 700mV rms into 15K Ω 3V rms into 8 Ω . Size 95 x 48 x 50mm. Weight 256 gms.

C1515
Stereo version of C15. £17.19 (inc. VAT)
Size 95 x 40 x 80. Weight 410 gms.

WITH A LOT OF HELP FROM ILP ELECTRONICS LTD

PROFESSIONAL HI-FI THAT EVERY ENTHUSIAST CAN HANDLE...

Unicase

Over the years ILP has been aware of the need for a complete packaging system for its products, it has now developed a unique system which meets all the requirements for ease of assembly, adaptability, ruggedness, modern styling and above all price.

Each Unicase kit contains all the hardware required down to the last nut and bolt to build a complete unit without the need for any special tools.

Because of ILP's modular approach, "open plan" construction is used and final assembly of the unit parts forms a compact aesthetic unit. By this method construction can be achieved in under two hours with little experience of electronic wiring and mechanical assembly.

Hi Fi Separates

UC1 PRE AMP UNIT: Incorporates the HY78 to provide a "no frills", low distortion, (<0.01%), stereo control unit, providing inputs for magnetic cartridge, tuner, and tape/monitor facilities. This unit provides the heart of the hi fi system and can be used in conjunction with any of the UP Unicase series of power amps. For ultimate hum rejection the UC1 draws its power from the power amp unit.

POWER AMPS: The UP series feature a clean line front panel incorporating on/off switch and concealed indicator. They are designed to complement the style of the UC1 pre-amp. Performance for each unit which includes the appropriate power supply, is as specified on the facing page.

Power Slaves

Our power slaves, which have numerous uses i.e. instrument, discotheque, sound reinforcement, feature in addition to the hi fi series, front panel input jack, level control, and a carrying handle. Providing the smallest, lowest cost, slave on the market in this format.

UNICASES

HIFI Separates					Price inc. VAT
UC1	Preamp				£29.95
UP1X	30 + 30W/4-8 Ω	Bipolar	Stereo	HiFi	£54.95
UP2X	60W/4 Ω	Bipolar	Mono	HiFi	£54.95
UP3X	60W/8 Ω	Bipolar	Mono	HiFi	£54.95
UP4X	120W/4 Ω	Bipolar	Mono	HiFi	£74.95
UP5X	120W/8 Ω	Bipolar	Mono	HiFi	£74.95
UP6X	60W/4-8 Ω	MOS	Mono	HiFi	£64.95
UP7X	120W/4-8 Ω	MOS	Mono	HiFi	£84.95
Power Slaves					Price inc. VAT
US1X	60W/4 Ω	Bipolar	Power Slave		£59.95
US2X	120W/4 Ω	Bipolar	Power Slave		£79.95
US3X	60W/4-8 Ω	MOS	Power Slave		£69.95
US4X	120W/4-8 Ω	MOS	Power Slave		£89.95

Please note X in part number denotes mains voltage. Please insert '0' in place of X for 110V, '1' in place of X for 220V (Europe), and '2' in place of X for 240V (U.K.) All units except UC1 incorporate our own toroidal transformers.

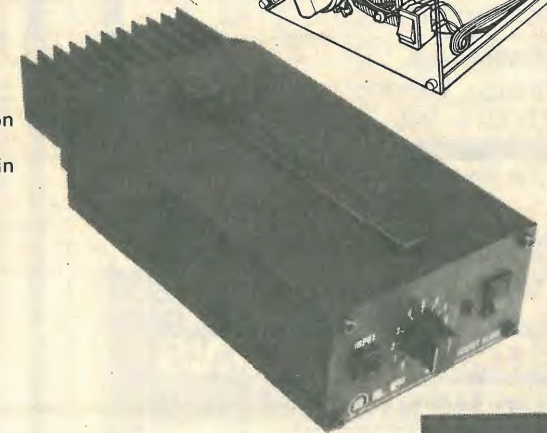
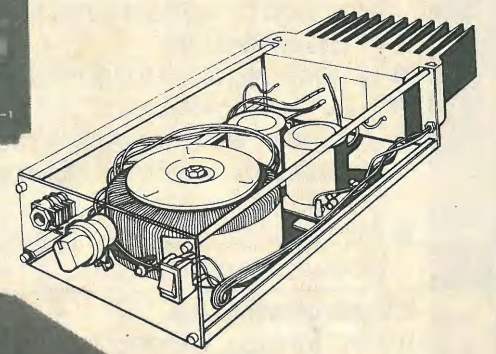

TO ORDER USING OUR FREEPOST FACILITY
Fill in the coupon as shown, or write details on a separate sheet of paper, quoting the name and date of this journal. By sending your order to our address as shown at the bottom of the page opposite, with FREEPOST clearly shown on the envelope, you need not stamp it. We pay postage for you. Cheques and money orders must be crossed and made payable to I.L.P. Electronics Ltd. if sending cash, it must be by registered post. To pay C.O.D. please add £1 to TOTAL value of order.

PAYMENT MAY BE MADE BY ACCESS OR BARCLAYCARD IF REQUIRED

Post to: ILP Electronics Ltd., Freepost, 5 Graham Bell House, Roper Close, Canterbury, CT2 7EP, Kent, England. Telephone: (0227) 54778. Technical: (0227) 64723. Telex: 965780.

Please send me the following _____
Total purchase price _____
I enclose Cheque Postal Orders Int. Money Order
Please debit my Access/Barclaycard No. _____
Name _____
Address _____
Signature _____

WW - 005 FOR FURTHER DETAILS

NEW Get started in Fibre Optics

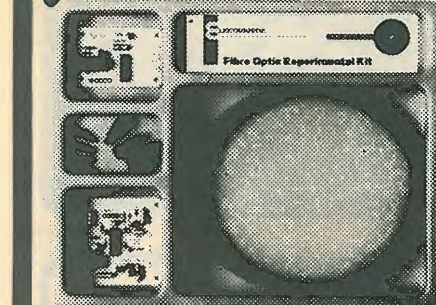

... with our new fibre optic experimental kit.

Features include:

- 0-10Mbit/s (NRZ) guaranteed to 15m with Polymer Cable. (Can be extended by using a glass fibre).
- TTL Compatible.
- No tools required to terminate cable.
- Fully tested modules.
- Complete with transmitter, receiver connectors and 5m of Polymer Cable.
- Also a full range of components for glass systems available.

Electrostatic Ltd.

9 Step Terrace, Winchester, Hants.
Tel. 0962 60916. Telex: 877255.

WW - 045 FOR FURTHER DETAILS

COMPUTER ACCESSORY BARGAINS from HENRY'S

I.T.T. 2020 CABINET

Complete PROFESSIONAL Case beautifully constructed with cut out for one CHERRY keyboard, plus ample room to house a COMPLETE SYSTEM, and power supply. Complete with fittings. (Case top detachable). Unit is silver-grey in colour. Robust construction. Sloping front with side ventilation. Ideal for NASCOM, ACORN, TANGERINE or your own system. Size 18" x 15 1/2" x 4 1/2" £27.50 (inc. V.A.T.) (front slopes) UK C/P £2.50



'CHERRY' ADD-ON KEYPAD

A compact 16 button keypad suitable for use with cherry keyboard to extend its functions. Supplied brand new with data. A 4 x 4 non-encoded single mode keyboard.



TEXAS TI99-4A

Colour, sound and a typewriter type keyboard for under £160. A truly expandable microcomputer system with a wide range of educational and games software.

MICRO STOCKISTS

BBC - DRAGON - SHARP - SPECTRUM TEXAS - ORIC - MICROPROFESSOR - ZX81 Nascom and Gemini Products. Also stocked range of monitors, printers and disc systems to suit most purposes.

£5.95 (inc. V.A.T.) UK C/P Free

ORDER BY PHONE OR CALL IN AND SEE FOR YOURSELF
Computer Shop
404/406 Edgware Road, London, W2 1ED Tel: 01-402 6822

P.M. COMPONENTS LTD VALVE & COMPONENTS SPECIALISTS

INTEGRATED CIRCUITS		SEMICONDUCTORS	
AN124 2.50	MC1495 3.00	BD159 0.85	BD166 0.55
AN214Q 1.35	MC1496 2.25	BD179 0.72	BD179 0.72
AN240P 2.80	MC1401BCP 1.00	BD201 0.83	BD201 0.83
AN612 2.15	MC145106P 0.32	BD202 0.65	BD202 0.65
AN7150 2.95	MC1723 7.95	BD203 0.78	BD203 0.78
BA521 3.35	MC1725 0.50	BD204 0.70	BD204 0.70
CA3123E 2.50	MC3357 2.25	BD205 0.15	BD205 0.15
ET76016 2.50	ML2318 1.75	BD223 0.48	BD223 0.48
HA1551 2.95	ML2319 1.25	BD225 0.48	BD225 0.48
HA1156W 2.50	ML2322 2.50	BD232 0.35	BD232 0.35
HA1366W 1.95	ML2378 1.95	BD233 0.35	BD233 0.35
HA1230 1.15	ML2388 4.20	BD234 0.10	BD234 0.10
LA4031P 2.70	ML920 4.12	BD236 0.45	BD236 0.45
LA4102 2.95	MSM5807 6.75	BD237 0.40	BD237 0.40
LA4400 4.15	PLL02A 5.75	BD238 0.40	BD238 0.40
LA4422 2.25	SA5A1025 7.25	BD241 0.09	BD241 0.09
LC7120 3.25	SA5A000A 3.05	BD242 0.50	BD242 0.50
LC7130 3.50	SA5A5010 6.35	BD246 0.60	BD246 0.60
LC7131 5.50	SA5605 1.75	BD247 0.32	BD247 0.32
LC7137 5.50	SA5705 1.75	BD248 0.32	BD248 0.32
LM565CH 0.95	SA5850 2.85	BD249 0.32	BD249 0.32
LM324N 0.45	SL901B 4.85	BD250 0.32	BD250 0.32
LM3800N 0.95	SL917B 6.65	BD251 0.32	BD251 0.32
LM3837 2.95	SL1310 1.80	BD252 0.32	BD252 0.32
LM3900N 1.95	SL1327 1.10	BD253 0.32	BD253 0.32
MC1313 1.15	SN76003N 1.95	BD254 0.32	BD254 0.32
MC1351P 1.50	SN76031N 1.95	BD255 0.32	BD255 0.32
MC1352P 1.25	SN76033N 1.95	BD256 0.32	BD256 0.32
MC1357 2.35	SN76034N 1.85	BD257 0.32	BD257 0.32
MC1358 1.58	SN76650N 1.15	BD258 0.32	BD258 0.32

DIODES		CRT TUBES	
AA119 0.08	BY206 0.14	4A119 0.08	4A119 0.08
BA102 0.17	BY208-800 0.33	4A120 0.17	4A120 0.17
BA115 0.13	BY210-800 0.33	4A121 0.17	4A121 0.17
BA145 0.16	BY221 0.30	4A122 0.17	4A122 0.17
BA148 0.17	BY222 0.30	4A123 0.17	4A123 0.17
BA154 0.06	BY223 0.30	4A124 0.17	4A124 0.17
BA155 0.13	BY224 0.30	4A125 0.17	4A125 0.17
BA157 0.30	BY225 0.30	4A126 0.17	4A126 0.17
BA166 0.06	BY226 0.30	4A127 0.17	4A127 0.17
BA167 0.06	BY227 0.30	4A128 0.17	4A128 0.17
BA168 0.06	BY228 0.30	4A129 0.17	4A129 0.17
BA169 0.06	BY229 0.30	4A130 0.17	4A130 0.17
BA170 0.06	BY230 0.30	4A131 0.17	4A131 0.17
BA171 0.06	BY231 0.30	4A132 0.17	4A132 0.17
BA172 0.06	BY232 0.30	4A133 0.17	4A133 0.17
BA173 0.06	BY233 0.30	4A134 0.17	4A134 0.17
BA174 0.06	BY234 0.30	4A135 0.17	4A135 0.17
BA175 0.06	BY235 0.30	4A136 0.17	4A136 0.17
BA176 0.06	BY236 0.30	4A137 0.17	4A137 0.17
BA177 0.06	BY237 0.30	4A138 0.17	4A138 0.17
BA178 0.06	BY238 0.30	4A139 0.17	4A139 0.17
BA179 0.06	BY239 0.30	4A140 0.17	4A140 0.17
BA180 0.06	BY240 0.30	4A141 0.17	4A141 0.17
BA181 0.06	BY241 0.30	4A142 0.17	4A142 0.17
BA182 0.06	BY242 0.30	4A143 0.17	4A143 0.17
BA183 0.06	BY243 0.30	4A144 0.17	4A144 0.17
BA184 0.06	BY244 0.30	4A145 0.17	4A145 0.17

WIREWOUND RESISTORS		BASES ETC.	
4Watt	10K 0.24	B7G Skirted	0.15
7Watt	10K-12K 0.19	B8G	0.30
11Watt	15K-22K 0.24	B9A	0.20
17Watt	15K-22K 0.28	B9A Skirted	0.30

ZENER DIODES		THERMISTORS	
BZX61 0.15	6V2 7V5 8V2 9V1 10V 11V 12V 13V	VA1005 0.23	7V Power Mike
BZX61 0.07	15V 16V 18V 20V 22V 24V 27V 30V	VA1065 0.23	batteries
BZX61 0.07	33V 36V 39V 47V 51V 56V 68V 75V	VA1104 0.70	TR175 £1.40
BZX61 0.07	82V 91V 100V 110V 120V 130V	VA850 0.45	other prices on request
BZX61 0.07	150V 160V 180V 200V 220V 240V 270V 300V	VA1097 0.25	

P.M. COMPONENTS LTD SELECTRON HOUSE, WROTHAM ROAD MEOPHAM GREEN, MEOPHAM, KENT DA130QY

A SELECTION FROM OUR STOCK OF BRANDED VALVES

A1714 18.50	EA491 0.60	EF731 1.80	HK90 1.05
AR112 0.70	EAC80 2.50	EF732 1.80	HL2K 3.50
AR122 0.70	EAC91 0.60	EF733 1.80	HL23DD 4.50
AR132 0.70	EAC92 0.60	EF734 1.80	HL23DD 4.50
AR142 0.70	EAC93 0.60	EF735 1.80	HL41DD 3.50
AR152 0.70	EAC94 0.60	EF736 1.80	HL42DD 3.50
AR162 0.70	EAC95 0.60	EF737 1.80	HL90 0.70
AR172 0.70	EAC96 0.60	EF738 1.80	HL90 0.70
AR182 0.70	EAC97 0.60	EF739 1.80	HL133/DD 3.50
AR192 0.70	EAC98 0.60	EF740 1.80	HR2 4.00
AR202 0.70	EAC99 0.60	EF741 1.80	HY90 1.00
AR212 0.70	EAC100 0.60	EF742 1.80	HVR2 3.00
AR222 0.70	EAC101 0.60	EF743 1.80	K3118 85.00
AR232 0.70	EAC102 0.60	EF744 1.80	K3118 85.00
AR242 0.70	EAC103 0.60	EF745 1.80	K3118 85.00
AR252 0.70	EAC104 0.60	EF746 1.80	K3118 85.00
AR262 0.70	EAC105 0.60	EF747 1.80	K3118 85.00
AR272 0.70	EAC106 0.60	EF748 1.80	K3118 85.00
AR282 0.70	EAC107 0.60	EF749 1.80	K3118 85.00
AR292 0.70	EAC108 0.60	EF750 1.80	K3118 85.00
AR302 0.70	EAC109 0.60	EF751 1.80	K3118 85.00
AR312 0.70	EAC110 0.60	EF752 1.80	K3118 85.00
AR322 0.70	EAC111 0.60	EF753 1.80	K3118 85.00
AR332 0.70	EAC112 0.60	EF754 1.80	K3118 85.00
AR342 0.70	EAC113 0.60	EF755 1.80	K3118 85.00
AR352 0.70	EAC114 0.60	EF756 1.80	K3118 85.00
AR362 0.70	EAC115 0.60	EF757 1.80	K3118 85.00
AR372 0.70	EAC116 0.60	EF758 1.80	K3118 85.00
AR382 0.70	EAC117 0.60	EF759 1.80	K3118 85.00
AR392 0.70	EAC118 0.60	EF760 1.80	K3118 85.00
AR402 0.70	EAC119 0.60	EF761 1.80	K3118 85.00
AR412 0.70	EAC120 0.60	EF762 1.80	K3118 85.00
AR422 0.70	EAC121 0.60	EF763 1.80	K3118 85.00
AR432 0.70	EAC122 0.60	EF764 1.80	K3118 85.00
AR442 0.70	EAC123 0.60	EF765 1.80	K3118 85.00
AR452 0.70	EAC124 0.60	EF766 1.80	K3118 85.00
AR462 0.70	EAC125 0.60	EF767 1.80	K3118 85.00
AR472 0.70	EAC126 0.60	EF768 1.80	K3118 85.00
AR482 0.70	EAC127 0.60	EF769 1.80	K3118 85.00
AR492 0.70	EAC128 0.60	EF770 1.80	K3118 85.00
AR502 0.70	EAC129 0.60	EF771 1.80	K3118 85.00
AR512 0.70	EAC130 0.60	EF772 1.80	K3118 85.00
AR522 0.70	EAC131 0.60	EF773 1.80	K3118 85.00
AR532 0.70	EAC132 0.60	EF774 1.80	K3118 85.00
AR542 0.70	EAC133 0.60	EF775 1.80	K3118 85.00
AR552 0.70	EAC134 0.60	EF776 1.80	K3118 85.00
AR562 0.70	EAC135 0.60	EF777 1.80	K3118 85.00
AR572 0.70	EAC136 0.60	EF778 1.80	K3118 85.00
AR582 0.70	EAC137 0.60	EF779 1.80	K3118 85.00
AR592 0.70	EAC138 0.60	EF780 1.80	K3118 85.00
AR602 0.70	EAC139 0.60	EF781 1.80	K3118 85.00
AR612 0.70	EAC140 0.60	EF782 1.80	K3118 85.00
AR622 0.70	EAC141 0.60	EF783 1.80	K3118 85.00
AR632 0.70	EAC142 0.60	EF784 1.80	K3118 85.00
AR642 0.70	EAC143 0.60	EF785 1.80	K3118 85.00
AR652 0.70	EAC144 0.60	EF786 1.80	K3118 85.00
AR662 0.70	EAC145 0.60	EF787 1.80	K3118 85.00
AR672 0.70	EAC146 0.60	EF788 1.80	K3118 85.00
AR682 0.70	EAC147 0.60	EF789 1.80	K3118 85.00
AR692 0.70	EAC148 0.60	EF790 1.80	K3118 85.00
AR702 0.70	EAC149 0.60	EF791 1.80	K3118 85.00
AR712 0.70	EAC150 0.60	EF792 1.80	K3118 85.00
AR722 0.70	EAC151 0.60	EF793 1.80	K3118 85.00
AR732 0.70	EAC152 0.60	EF794 1.80	K3118 85.00
AR742 0.70	EAC153 0.60	EF795 1.80	K3118 85.00
AR752 0.70	EAC154 0.60	EF796 1.80	K3118 85.00
AR762 0.70	EAC155 0.60	EF797 1.80	K3118 85.00
AR772 0.70	EAC156 0.60	EF798 1.80	K3118 85.00
AR782 0.70	EAC157 0.60	EF799 1.80	K3118 85.00
AR792 0.70	EAC158 0.60	EF800 1.80	K3118 85.00
AR802 0.70	EAC159 0.60	EF801 1.80	K3118 85.00
AR812 0.70	EAC160 0.60	EF802 1.80	K3118 85.00
AR822 0.70	EAC161 0.60	EF803 1.80	K3118 85.00
AR832 0.70	EAC162 0.60	EF804 1.80	K3118 85.00
AR842 0.70	EAC163 0.60	EF805 1.80	K3118 85.00
AR852 0.70	EAC164 0.60	EF806 1.80	K3118 85.00
AR862 0.70	EAC165 0.60	EF807 1.80	K3118 85.00
AR872 0.70	EAC166 0.60	EF808 1.80	K3118 85.00
AR882 0.70	EAC167 0.60	EF809 1.80	K3118 85.00
AR892 0.70	EAC168 0.60	EF810 1.80	K3118 85.00
AR902 0.70	EAC169 0.60	EF811 1.80	K3118 85.00
AR912 0.70	EAC170 0.60	EF812 1.80	K3118 85.00
AR922 0.70	EAC171 0.60	EF813 1.80	K3118 85.00
AR932 0.70	EAC172 0.60	EF814 1.80	K3118 85.00
AR942 0.70	EAC173 0.60	EF815 1.80	K3118 85.00
AR952 0.70	EAC174 0.60	EF816 1.80	K3118 85.00

No Contest!

The SC61 waveform analyser from Sencore stands head and shoulders above any other oscilloscopes for speed, accuracy and versatility even from semi-skilled operators — **and we're prepared to come round and prove it.**

For an on-site test and more information:
Mike Dawson 01-897 6446.



**Fieldtech
Heathrow**

Fieldtech Heathrow Limited
Huntavia House 420 Bath Road
Longford Middlesex UB7 0LL
Telex: 23734 FLDTEC G

WW - 022 FOR FURTHER DETAILS



FOR EVERYTHING IN ELECTRONICS Wirelessworld

Editor:
PHILIP DARRINGTON
01-661 3128

Deputy Editor:
GEOFFREY SHORTER, B.Sc.
01-661 8639

Technical Editor:
MARTIN ECCLES
01-661 8638

News Editor:
DAVID SCOBIE
01-661 8632

Drawing Office Manager:
ROGER GOODMAN
01-661 8690

Technical Illustrator:
BETTY PALMER

Advertisement Manager:
BOB NIBBS, A.C.I.I.
01-661 3130

BARBARA MILLER
01-661 8640

Northern Sales:
HARRY AIKEN
061-872 8861

Midland Sales:
BASIL MCGOWAN
021-356 4838

Classified Manager:
BRIAN DURRANT
01-661 3106

IAN FAUX
01-661 3033

Production:
BRIAN BANNISTER
(Make-up and copy)
01-661 8648

Publishing Director
DAVID MONTGOMERY
01-661 3241

Engineering, not politics

Even in the pre-war days when Japanese industry was best known for its imitative tendencies, its imitations were often better products than the originals. Modern Japanese engineering demonstrates little need to take other nations' ideas and has made Japan an industrial giant.

In design and reliability, products from Japan have gained a formidable reputation for quality — to the extent that they now dominate world markets in several important groups of product. With the exception of those Western companies who refuse to be intimidated and who also possess reputations for high quality, European and American firms tend to see the reply to imports from the Far East in political, rather than in commercial and engineering terms. They require the Japanese to restrict their exports voluntarily and frequently ask politicians to apply pressure to that end.

An approach as negative as that to the imbalance of trade can surely not succeed over a long period. In reply to huge imports from Japan, the proper action is to redress the balance by exporting, not politicking. Admittedly, it is not easy to sell to the Japanese but, according to the Department of Trade, "formal barriers are disappearing and the desire of the Japanese to be self-supporting — the 'Buy Japanese' policy — is on the way out. Import tariffs on over 2000 products have now been reduced to a lower level than those of European countries or the US".

In common with any other manufacturers, the Japanese want the best products at the lowest price. If a UK exporter can supply well-designed products, either to fill a gap in Japanese production or to beat local efforts on quality or price, he will win orders.

An important point to watch is that the

customer must be given what he wants, not what the vendor thinks he ought to want. Time and time again, Western makers of, for example, audio equipment have introduced new models in enclosures which they thought were sensible and attractive, in spite of the fact established by the successful marketing of Japanese products that customers prefer satin chrome, coloured lights and masses of knobs and switches. Presentation is a matter of taste and who is to say that the customers are wrong?

This office recently received a note from a maker of illuminated switches, in which he claimed that his company has taken massive orders from Japan and is now going into Hong Kong. The customers say that the switches are visually attractive to them, they are reliable and are cheaper to buy than locally made types: there is therefore a ready sale for them in Japan.

British industry began the industrial revolution and was able to dominate world markets when it was possible to tell customers what they could have and why they should want it. In the words of Adam Smith: we "founded a great empire for the sole purpose of raising up a people of customers". Perhaps more of our industrial base would still be firm if our manufacturers had recognised a good deal earlier that the world has developed while they were not looking, and will not now buy equipment that is not designed and made with customers in mind.

George Moore said that "a man travels the world over in search of what he needs and returns home to find it". Perhaps we could reduce the number of homing customers by making sure they find what they need here, not what we feel they should need.

Out of this world for value!

ET Not our extra-terrestrial friend, but a versatile bench power supply —

— the ET30/2

For a modest price it will provide you with:

2 outputs at 0 to 30 volts d.c. at 1 amp or
2 outputs at 0 to 15 volts d.c. at 2 amps or
0 to 30 volts d.c. at 2 amps or 0 to 60 volts
d.c. at 1 amp or 0 to 15 volts d.c. at 4 amps.

from



Farnell

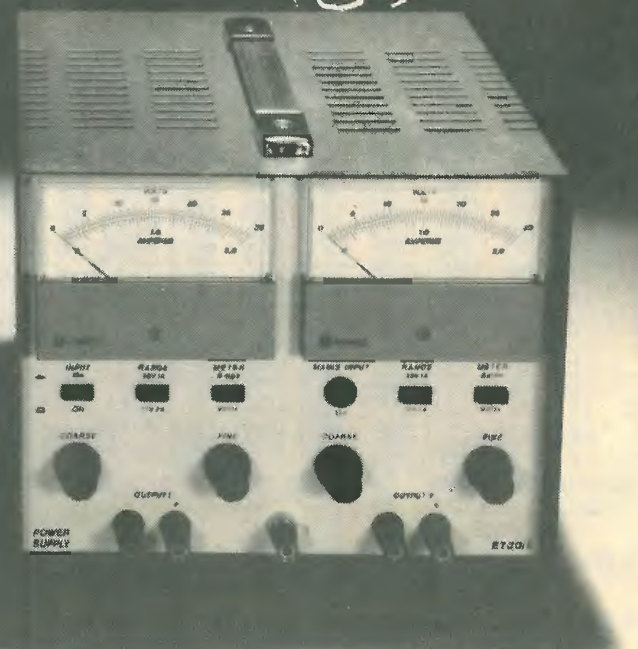

Send for details now from: FARNELL INSTRUMENTS LIMITED · WETHERBY · WEST YORKSHIRE LS22 4DH
TELEPHONE (0937) 61961 · TELEX 557294 FARIST G | REGIONAL OFFICE TELEPHONE (05827) 66123/4 · TELEX 826307

WW - 034 FOR FURTHER DETAILS

C.B. market collapse?

The Home Office tells me that fewer new CB licences were issued during the first quarter of 1983 than the number of licences that lapsed. At the end of April valid licences totalled 289,108 compared with 313,318 at the end of November 1982. The percentage of renewed licences seems to vary widely from month to month: 42% in October 1982; 72% in November; and only 27% in December. Fidelity Radio has claimed that its CB division lost £700,000 in the year to March 1983 and the firm has since disposed of the division "for a nominal sum", blaming "the collapse of the CB radio market".

The Japanese radio communications industry seems to be setting its sights on the para-military field with increasing emphasis on such products as v.h.f./u.h.f. manpack equipment providing digital encryption. European communications firms have long been worried at the prospect of a full-scale entry of Japan into defence electronics.

Antennas galore!

I have to confess that I did not attend ICAP 83 (Third International Conference on Antennas and Propagation, London, April 1983) but I have been making up for this omission by ploughing (or at least skimming) through the two thick volumes of papers (IEE Conference Publication 219). This is no lightweight matter: 193 papers filling 961 pages from authors whose names literally span A to Z (O. Aboul-Atta to Zi Shen Lui in volume 1 and I. Y. Ahmed to Z. W. Zhang in volume 2!). One really does wonder how many of the delegates managed, in four days, to absorb almost 200 papers – or indeed whether thereby they learned much that was of vital importance to them. These large international conferences, free from the constraints of "commercial" exhibitions do tend to take off into the stratosphere or, more appropriately in this case, the ionosphere. Radio propagation and aerials (to get back on the editorial wavelength of *Wireless World*) are both subjects that envelope themselves in an unusual degree of mythology and mysticism. I hasten to add that there are interesting and some thoroughly practical papers among the 193 but it could be argued that, since these come over clearly from the printed page, attendance was possibly not the optimum learning process. It is always said, of course, that the most interesting discussions at conferences are those that take place out in the bar rather than in the conference hall. Experience tends to support that view – although the more memorable conversations seldom seem to relate to conference topics!

The difficulty for the non-specialist reader (or delegate) is to decide what really

is new and what is not. ICAP 83 included some useful invited survey papers, though apparently prepared independently of the other contributions.

A. W. Rudge of ERA Technology Ltd in "Current trends in antenna technology and prospects for the next decade" highlights three major themes, the influence of environmental factors, the impact of v.l.s.i. electronics and the continuous search for improved characteristics. He aptly quotes Professor Mayes of the University of Illinois: "The popular conception in 1950 was that electromagnetics was a mature field and that it was improbable that any new discoveries remained to be made in the field of antennas. The development of frequency-independent antennas was certainly evidence to the contrary. Today similar sentiment seems to be prevalent. History shows it prudent to be sceptical." 193 papers suggests there must still be rich ore to be mined in these subjects.

Moral persuasion?

The BBC took the opportunity, as hosts of the 17th European DX Council Conference, to launch another strong attack on the 10% increase in "jamming" of h.f. broadcasts by the USSR since the Polish crisis of December 1981. Douglas Muggidge, managing director of BBC External Broadcasting, protested "The h.f. bands are very congested. There is more broadcasting than they can contain satisfactorily. A conference is soon to be held, the first session in 1984, with the task of trying to plan and regularize this position. Its job is made extremely difficult, if not impossible, by the large amount of 'deliberate, harmful interference' – better known as 'jamming' – which is present within the shortwave bands.

Many people have not been aware of the extent to which this is a worldwide problem. Every country that broadcasts on h.f. and all who listen on h.f. are affected. Perhaps there may be a solution. If there is not, then it is difficult to see how any order can be brought out of the chaos that exists at certain times of the day".

The BBC apparently hopes that "moral persuasion", plus the fact that the USSR is anxious that its own transmissions should be well received throughout the world may prove a powerful argument to reduce jamming. Keith Edwards presented data showing co-channel and adjacent-channel jamming as monitored in Vienna and at Caversham that underline the extent of the current problem. This is particularly true on the 15, 17 and 21MHz broadcast bands, with between 70-80% of channels (pre-WARC 1979) affected from about 1200 to 1800 hours on 17MHz, over 60% on all three bands around 1600 hours, etc. Other statistical data show the massive use made of the 6MHz broadcast band. Although

WARC 1979 gave Western broadcasters much less additional spectrum than they sought, over 30 countries are already using the new frequencies despite the WARC agreement not to do so until after the 1984-86 planning conferences. There are also a number of countries using parts of the spectrum not allocated to broadcasting. China, for example, has quit out-of-band operation at 7.0 to 7.1MHz but is now using many channels around 8.3MHz!

A happier prospect arises from the use of satellite feeds. The BBC are using digital audio at 128kilobits (two adjacent 64kb/s speech channels) to distribute programmes via satellite to overseas relays; these links have uniform frequency response to 6kHz, distortion around 1% or less and s:n ratio of about 50dB. One result is that the BBC may soon reduce long-distance h.f. coverage from the UK of areas better served from the relay bases of the BBC or the Foreign & Commonwealth Office: Atlantic Relay on Ascension Island; Caribbean Relay (Antigua); East Mediterranean Relay (Cyprus); Far Eastern Relay (Singapore); Eastern Relay (Masira) and (later) a possible relay at Hong Kong, and an East African Relay in the Indian Ocean.

Stereo all ways

A new twist to the American a.m.-stereo fight between the four competing systems has been given by demonstrations at NAB of the prototype of a new Sansui multisystem a.m. stereo tuner, type TU-S77AMX, that uses a Japanese-manufactured single-chip decoder handling signals in any of the four systems. A.m.-stereo in the USA has been delayed by the FCC "leave it to the market place" decision. By April 1983 there were 50 stations using the Harris system, around 30-plus with Kahn, six using Motorola and three using Magnavox out of some 4600 commercial a.m. stations. However, retail price of the Sansui tuner is around \$400 and their car radio tuner around \$50. Even with multisystem decoding it will still be necessary for American broadcasters individually to make the difficult choice between the four systems.

Mercurial thoughts

I do not know what the new Mercury communications network will do for British business – but it must already be helping our printers and typographers and illustrators. That is if the three very large and very glossy advertising brochures that have come my way are anything to go by. They proudly proclaim: "Mercury is the new force in communications . . . it exists to facilitate the dynamic interchange of ideas that are vital to your business . . . Mercury means communications. At the speed of thought". The global village, I am told, is

no longer a concept but a reality. Pages are filled with large colour pictures of eggs, a charming little chameleon, a chisel, a honeycomb and a small globe in the palm of a giant hand. All this represents "a new approach to communications for the '80s and beyond".

Just the thing presumably for the businessman who has caught a chameleon, intends to put it inside an egg-shell after slicing the top off with his chisel, and is not afraid of being stung by bees. Or is my dynamic interchange of ideas failing me?

In brief

Costs of the NASA Space Telescope project may exceed \$1000-million instead of the original estimate of \$435m and is unlikely to be launched until 1986 or later . . . Launch of the second Tracking and Data Relay Satellite (TDRS) is being delayed in the hope that NASA can find out what went wrong with the first launch last March . . . A spate of fraud and cheating – "doctoring" and "massaging" data – in scientific research papers has led to Nicholas Wade of the *New York Times* claiming: "It is not just a matter of rotten apples in the barrel but something to do with the barrel itself" . . . the opportunities to cheat are becoming more frequent because of the readiness of laboratory chiefs to put their names to papers prepared by junior colleagues with little or no supervision".

AMATEUR RADIO

Planning the bands

The problems of spectrum regulation are increasingly reflected inside the amateur bands. There have been some gains – 7000 to about 7030kHz or so is now refreshingly clear of Radio Beijing (Radio Peking) in the evenings and has become a far more usable piece of spectrum. The upper part of the world "exclusive" 7000-7100kHz however, still includes broadcast "intruders" such as Radio Tirana on 7065kHz.

But there is increasing unease within the amateur movement over the future of "voluntary band-planning".

For very many years mandatory sub-band allocations have been part of North American amateur licensing in the USA and Canada, to provide exclusive A1A (c.w.) segments and also in connection with American "incentive licensing" whereby higher "grades" are given access to additional segments of the bands.

Until the immediate post-war period no attempt was made to segment the fre-

quency bands available to British amateurs. In 1948 the RSGB set-up a working party (I was a member) which, *inter-alia*, recommended a voluntary h.f. band-plan (our first effort was so unpopular that we promptly revised it). Basically this followed North American practice in locating exclusive A1A segments at the low-frequency ends of the bands, and later formed the basis of the IARU Region 1 recommendations. These also took into account the then still rare use of r.t.t.y., although neither IARU or RSGB are official regulatory bodies.

As the years have gone by the band-plan has been extended to v.h.f. and u.h.f. bands and covers more and more modes and special activities, offering protection to minority interests, such as "raynet" emergency services, beacons, space satellites, "local" and "long-distance" working, repeaters and dividing bands into simplex channels, etc.

The IARU decided that, in view of the limited (50kHz) bandwidth, there should be no s.s.b. on the new 10.1MHz band (for different reasons the Home Office has temporarily similarly restricted UK operation on 18 and 24MHz). Where countries, such as South Africa, have declined to follow these recommendations, both IARU Region 1 Bureau and the RSGB officials have separately urged the South Africans to reconsider their decision. Being primarily a c.w. operator, I personally benefit from the new IARU recommendations, but nevertheless it does raise important matters of principle: are such organizations as the IARU justified in assuming a "regulatory" role that goes well beyond the original concepts of "voluntary bandplanning" without first providing greater "accountability" to those whose activities are being restricted? Individual amateurs have no direct control over IARU decisions, member societies have one vote per member, regardless of the size of the individual societies.

The 1983 IARU statistics show that there are now roughly 1.8-million amateur radio operators world-wide, using 1.4-million stations. Licensed members belonging to IARU member-societies are, however, under 450,000, despite the fact that 22% of the countries make membership of their national society an obligatory condition of the licence. The RSGB is listed as having, as members, precisely 50% of the UK's 40,000 licensed amateurs, of whom the majority are v.h.f.-only operators. In such circumstances can "voluntary bandplanning" continue to work?

No r.m.s. power!

W. J. Omer, G3DOJ, who lectures in electrical and electronic engineering in higher education, is concerned to find that some 90% of his students believe that power in an a.c. circuit can correctly be

defined as an r.m.s. quality. The term r.m.s. watts has been creeping into the literature for the past 20 years – stemming largely from the audio field where it first came to be used to distinguish between "continuous average output" ratings and "music power" ratings (now tending to be replaced by "dynamic headroom") and the even less demanding peak envelope power rating.

Bill Omer has for some time been waging virtually a one-man crusade against 'r.m.s. power' which, since the definitions of r.m.s. voltage and current in an a.c. circuit are themselves derived from power, is a technical nonsense. He notes that 'r.m.s. power' has spread from the audio field to r.f. amplifiers and transmitter ratings in the editorial and advertising columns of many technical journals. When challenged some writers and firms have dismissed his objections as semantics while others insist that power is an r.m.s. quantity. To Bill Omer, r.m.s. watts is as ludicrous as 'average feet'.

A problem for the transmitter engineer is that "continuous wave" or c.w. has come to mean the A1A mode which is far from continuous. Nevertheless there do seem very good reasons for *not* using either r.m.s. watts or even watts (r.m.s.)!

Notes and news

Since June 1 the Home Office has imposed a 50 per cent increase in the annual amateur radio licence fee: from £8 to £12. This means that with RAE, Morse Test fees, training fees, travelling expenses, etc, it now costs around £50 or more to obtain a Class A transmitting licence issued for purposes of "self-training, inter-communication and technical investigations". It seems regrettable that at a time when emphasis is being placed on the need to encourage expansion of "sun-rise industries" such high barriers are being erected, affecting particularly the younger enthusiasts, or those who may later be seeking employment in the still-expanding communications field.

There must be a diminishing number of people who can recall actually hearing Pip Eckersley announcing that they were listening to "Two Emma Toc (2 MT) Writtle testing". The historic callsign, converted to G2MT, was due to come on the air on July 2 and should be heard frequently later this year. The Home Office has re-allocated the callsign at the request of the recently formed "Marconi Radio Society", formed by enthusiasts at the Stanmore headquarters of Marconi Space and Defence Systems.

The RSGB has decided to hold future annual National Amateur Radio Exhibitions and Conventions at the National Exhibition Centre in Birmingham. The 1984 dates are April 28-29.

PAT HAWKER, G3VA

Typewriter to daisywheel printer

With an Olivetti Praxis typewriter, this interface makes one of the cheapest word-processing printers around. It can be used with any microcomputer fitted with an RS232 or RS423 port.

by Neil Duffy

A typewriter-printer offers a number of advantages over a conventional daisy-wheel printer with no keyboard. For example, headings can be added to its output and margins set from the keyboard without the requirement to send special control codes from the computer, although this can be done if required. When not in use as a printer the typewriter can still be used in the normal manner.

The typewriter chosen for conversion here is the Olivetti Praxis series compact typewriter which was one of the first electronic typewriters and is well proven. It is also used as the basis of a number of commercially available printers and has turned out to be an excellent choice for this application. It is available in two versions, the Praxis 30 and the Praxis 35. Both feature interchangeable daisywheels, automatic correction of the last ten characters typed, and cartridge ribbon loading with a choice of correctable, carbon or fabric ribbons. The two models are almost identical but the 35 has a type-head position indicator and keyboard selection of 10, 12 or 15 characters per inch. Type pitch on the Praxis 30 is preset in the factory by means of links on the circuit board.

Daisy-wheel printers are in general much slower than their dot-matrix or thermal counterparts and are intended for use where letter quality output is required. They are not ideal for day to day listing of programs because of their relatively low speed. The basic typewriter mechanism is capable of a maximum print speed of around 8 to 10 characters per second and so a standard baud rate of 75 was chosen for the computer-interface to give a print speed of 7.5 characters per second.

A special feature of the interface is the provision of an electronic paper sensor on the typewriter to halt the computer output when the paper has run out. This feature is seldom provided even on high cost printers but has been found to be invaluable when errors are made in estimating the length of text that can be printed on a page.

The typewriter keyboard circuit (Fig. 1) operates on a matrix scanning principle. Each of the matrix columns is pulsed low

in turn. When a key is pressed the appropriate pulse is fed on to a particular keyboard matrix row. The typewriter electronics uses the row and pulse timing information to determine which key has been pressed.

The interface (Fig. 2 and Fig. 3) consists of a circuit board powered from the typewriter 5V power supply. Connection to the typewriter is made via a 40-way ribbon cable. In the interface, data from the computer is received by a uart and decoded by eeprom IC₄. The three least significant bits output from the eeprom are fed to multiplexer IC₆ which has its inputs connected to the keyboard columns and which selects the appropriate strobe pulse. The next three bits from the eeprom route

the selected pulse via demultiplexer IC₇ to the selected keyboard row. The seventh bit controls the typewriter shift function and the eighth triggers a circuit which signals back to the computer to halt data transmission until the typewriter has completed a carriage-return, line-feed operation.

Circuit operation

Incoming serial data is buffered by the RS232 receiver IC₁ and fed to the uart IC₂ which decodes the serial data and presents it in parallel form to the eeprom IC₄. The clock to the uart is derived from a 2.4576MHz crystal via the divider IC₃, configured for 75 baud operation and providing clock pulses to the uart at 16 times this rate. The uart must be set up to match the format of the incoming serial data from the computer. This is done by selecting links on the circuit board according to Table 1.

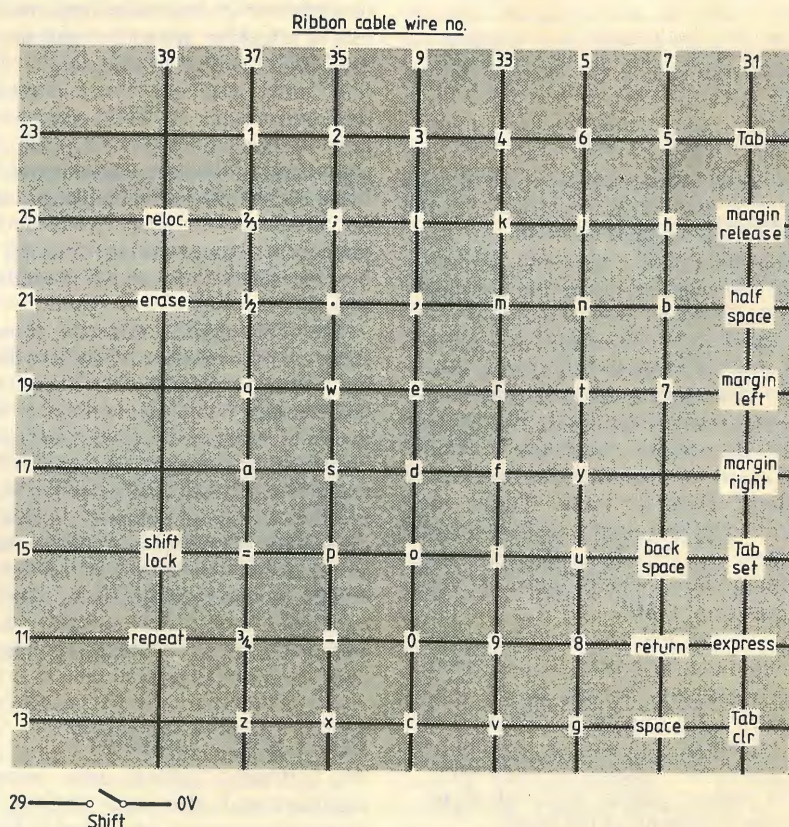
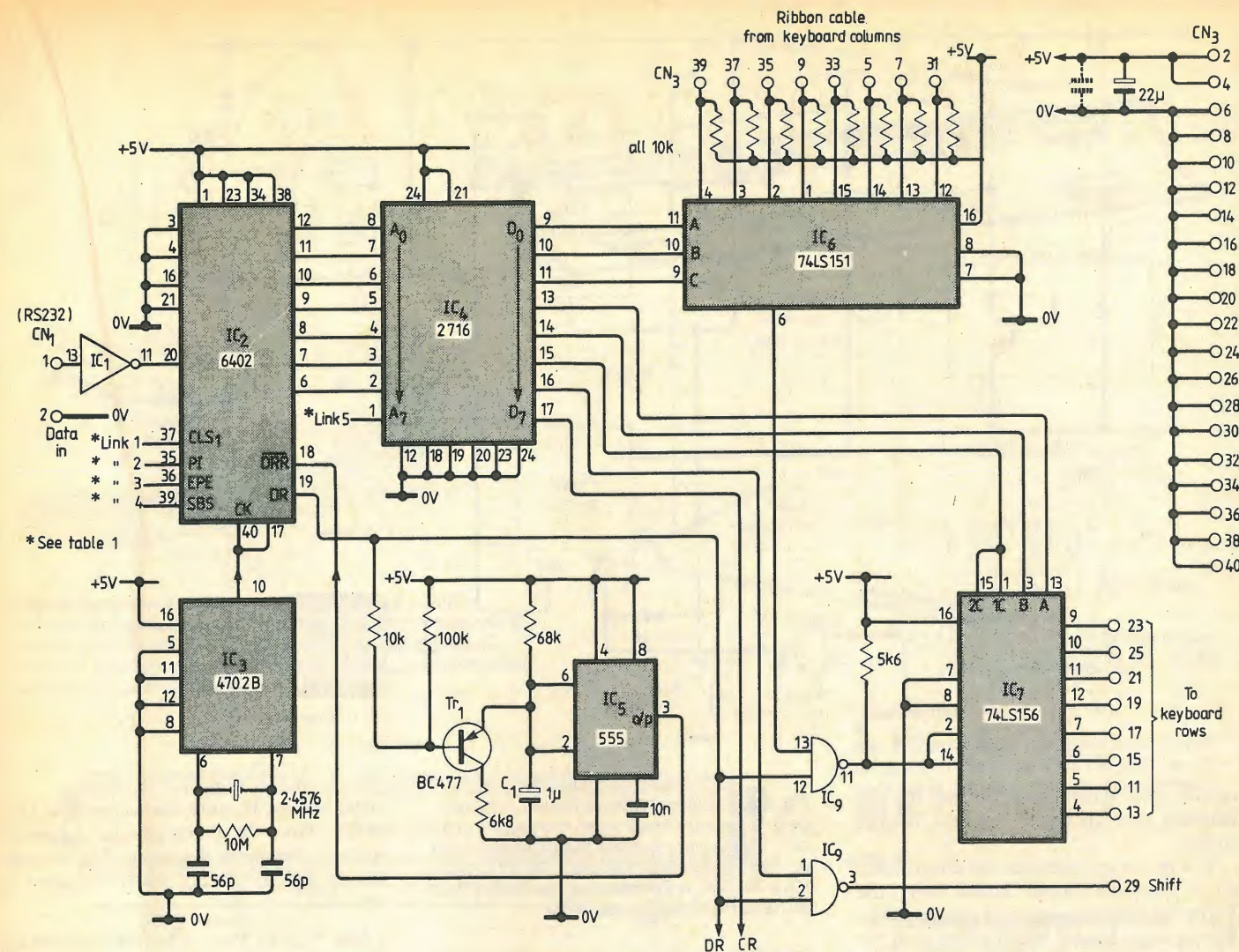

Fig. 1. Typewriter keyboard matrix: columns are each pulsed low in turn and pressing a key connects a column to a row. For clarity, diagram shows lower-case characters only.



When a data word is received by the uart it generates a high-going data-ready signal which turns off Tr₁ releasing the short circuit across C₁ on the 555 timer IC₅. Capacitor C₁ charges up towards 5V and at the end of a time period of approximately 70ms reaches the timer threshold voltage level. The output from the 555 goes low and resets the data-ready signal from the uart. Transistor Tr₁ turns on, discharging C₁ until the voltage on C₁ falls below the timer trigger voltage. The 555 output then reverts to the high state. The data-ready signal from the uart is used to strobe data to the keyboard via IC₉.

The eeprom is used to convert the incoming ASCII code from the computer into an output code suitable for energising the keyboard rows at the correct time. The contents of the eeprom are shown in Table 2. The eeprom is programmed to cause the typewriter to print spaces in place of ASCII codes for which the daisy-wheel has no corresponding symbol. ASCII codes from 0 to 32 are programmed to cause the typewriter to set and clear tabs, margins and so on.

During typewriter carriage-return/line-feed operations the data output from the computer must be halted by setting negative the clear-to-send (CTS) line on its RS232 port. This is done to prevent data loss caused by the typewriter buffer overflowing. When a carriage return signal is received from the computer, IC_{10b}

Fig. 2. Incoming serial data from the computer is converted by the interface into parallel data in a form suitable for connection to the keyboard matrix of the typewriter. IC₁ is a section of an MC1489 line-receiver device.

latches with its \bar{Q} output low. The \bar{Q} output is reset to the high state when S₁ on the interface is pressed or when the typewriter has completed a line-feed operation. This latter is detected by monitoring an existing limit switch on the line-feed mechanism.

For the handshake circuit to operate correctly, the typewriter must perform a carriage-return and then wait until the print head has returned to the left margin before performing a line-feed and thus operating the limit switch. If this is to happen the computer has to output a carriage-return and a line-feed symbol in the correct sequence. Because there is no convention for the sequence the interface has to allow for both possibilities. This is done by connecting a link on the interface board to select data either from locations 0 to 127 or from locations 128 to 255 on the eeprom. The data in the first set of locations is identical to that in the second except that in the second set, incoming carriage-return commands cause the printer to carry out a line-feed operation and line-feeds cause it to carry out a carriage-return.

The paper sensor is a reflective opto-

switch device with built-in infra-red led. Resistors R₁, R₃ and the sensitivity adjusting potentiometer R₂ are mounted on a small circuit board which is attached to the sensor mounting bracket. The paper-low signal from the sensor is fed back along the ribbon cable to the interface card.

Paper-low signals are inhibited by IC₈ until the CR output from the eeprom indicates that a carriage return has been received from the computer. If the paper is low, then at the end of the current print line IC_{10a} latches with its Q output low. Led₁ lights and Tr₂ is turned off sending the CTS line to the computer negative to prevent any further data transfer. IC_{10a} is restored to the high state by pressing S₁ after feeding a fresh sheet of paper into the typewriter. If S₁ is pressed when the paper low signal is still active then a further line of text will be printed. A -5V supply for the collector resistor of Tr₂ is provided by the negative-voltage generator IC₁₁. Note that the CTS signal taken from Tr₂ collector is not a full-specification RS232 signal in terms of voltage swing but is perfectly adequate for the short cable likely to be required.

Construction

There is a shortage of space inside the typewriter casing so the interface was housed outside in a small metal box. It connects to the typewriter via a 40-way

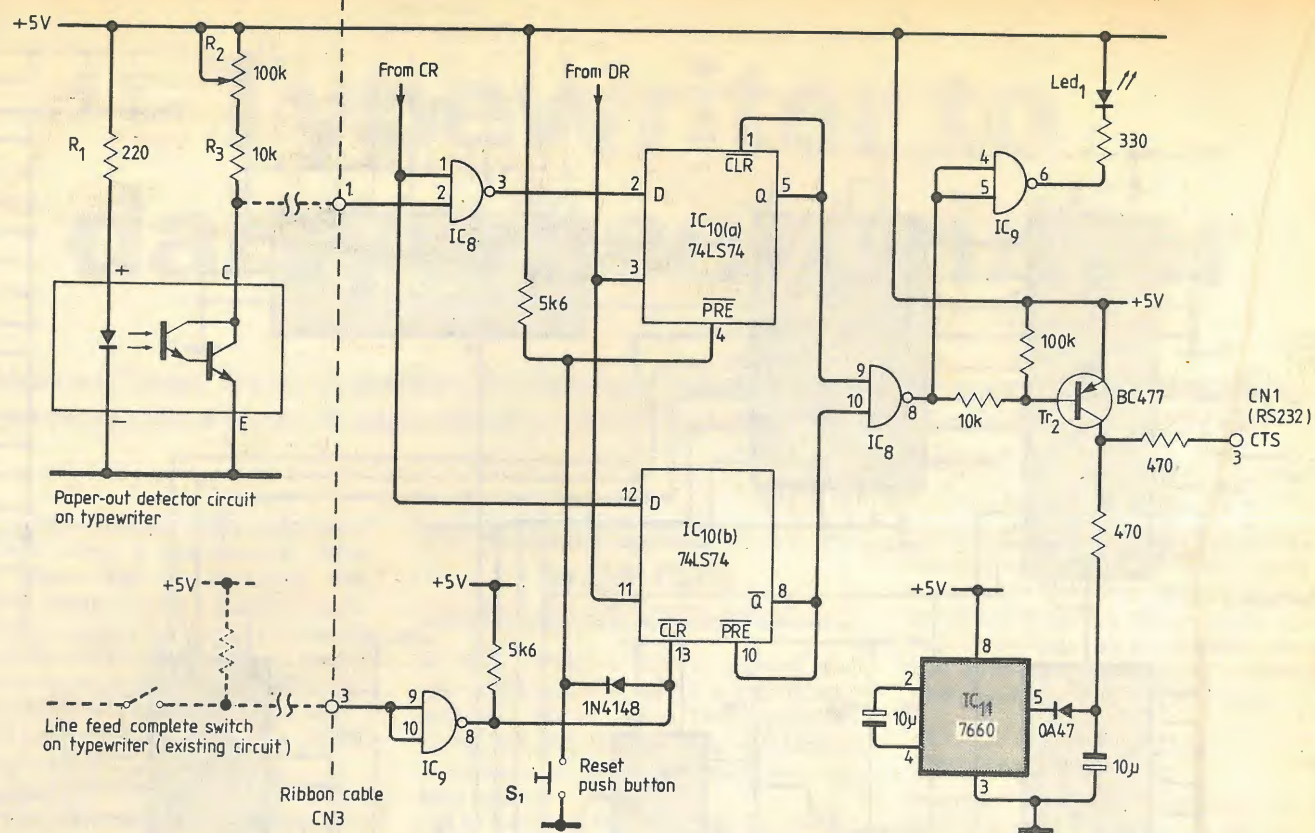

Fig. 3. Output from the computer is halted by this sensor circuit when the paper runs out. This feature is often not provided even on high-cost printers. IC₈ is a 74LS132 and IC₉ a 74LS03. A suitable opto-switch is type 307-913 from RS Components.

capacitor for every two i.c.s. Remember when connecting wires both to the typewriter and to the interface that some of the i.c.s are static-sensitive m.o.s. devices.

The photoelectric sensor is fitted onto a bracket mounted underneath the typewriter platen roller and views the paper through a hole cut in the paper guide (Fig. 6).

Commissioning the interface

With the interface disconnected from the typewriter, feed a sheet of paper into the typewriter and monitor the voltage at pin 1 of the connector at the end of the ribbon

cable. Adjust R₂ until the voltage just falls to 0V. Give the potentiometer a further turn in the same direction. The voltage should now rise to 5V when the paper is removed.

Table 1: Links 1 and 4 in this table set up the uart for the expected serial data format. Link 5 selects appropriate data from the eeprom for the expected carriage-return, line-feed sequence from the computer (see text).

Link	Function	Low (0V)	High (+5V)
1	character length	7 bits	8 bits
2	parity inhibit	enable	inhibit
3	even parity enable	odd	even
4	stop bit select	1 bit	2 bits
5	CR-LF sequence	LF-CR	CR-LF

Fig. 4. 40-way ribbon cable connects the interface to the underside of the typewriter main circuit board. Alternate wires in the ribbon are connected to +5V or 0V either at the interface end or the typewriter end. This helps to prevent crosstalk between the signal wires.

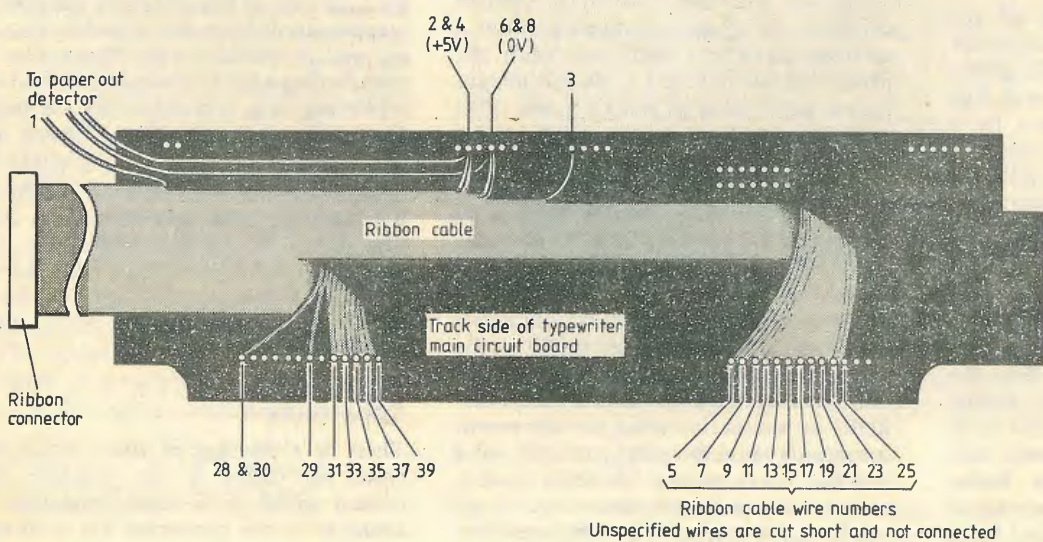

ribbon cable which passes through the gap between the typewriter top and bottom covers.

The prototype interface was constructed on a Eurocard circuit board using the Verewire interconnection technique. The 40-way cable header which mates with the ribbon cable from the typewriter is mounted on the end of the interface board and protrudes through a slot cut in the side of the case. The cable header serves to locate one end of the board. The other end is attached to the case by two screwed spacers. A DIN socket attached to the case provides the RS232 connection to the computer and a flying lead from this socket mates with a connector on the circuit board.

A 22µF tantalum bead capacitor decouples the power supply at the ribbon connector and 0.01µF decoupling capacitors are fitted to the board, one

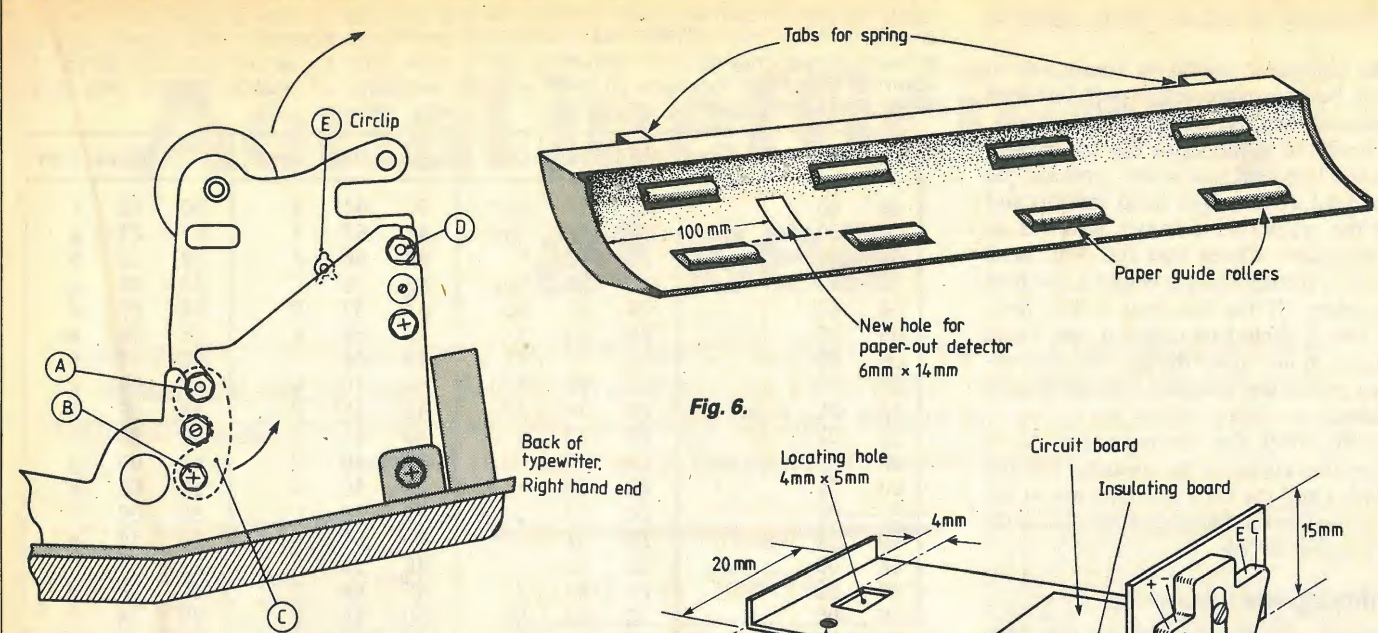

Fig. 5. Platen roller must be swung upwards to allow access for fitting the paper-out detector. Remove screw B on the right-hand roller support bracket. Swing plate C clear on the right-hand bracket and swing the platen roller assembly upwards, pivoting it about nut D.

Fig. 6.

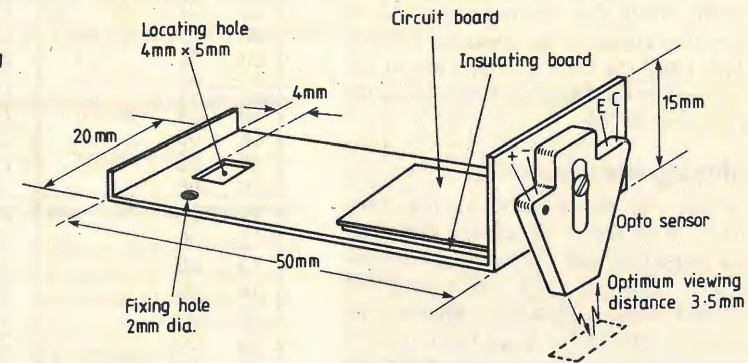
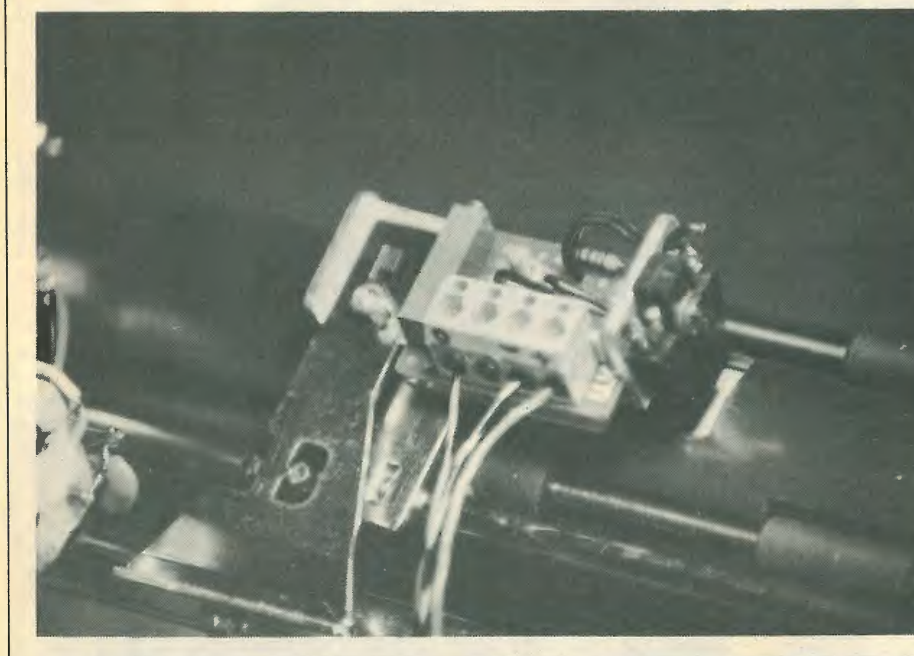

Fig. 7. Opto-sensor mounted underneath the platen roller views the paper through a hole cut in the paper guide roller carrier (Fig. 6).

Fig. 8.

Attaching the paper sensor

The paper sensor is mounted on a bracket on the underside of the platen roller. A hole must be cut in the paper guide under the platen roller for the sensor to view the paper through. To cut the hole the guide must be removed from the typewriter. Remove from the rear of the platen roller the four springs which tension the paper guide and the paper bail bar. Next refer to Fig. 5 and pivot the whole platen roller assembly upwards. Remove the small spring which can now be seen on the underside of the assembly at the right hand end. Remove circlip E from the right hand bracket and pull the bar that was retained by the circlip out of the bracket. The bar can now be sprung to enable the paper guide to be removed. To avoid damaging the guide a hot soldering iron can be used to melt a hole in the plastic in the position shown in Fig. 6. The hole should be carefully trimmed with a file to ensure that there are no sharp edges that can snag the paper. The mounting bracket for the sensor is shown in Fig. 7 and is attached as shown in Fig. 8 to the left hand spring bar on the underside of the platen roller by a single screw.



Test the connections to the typewriter by shorting out rows and columns at the connector on the end of the ribbon. Check by referring to Fig. 1 that the typewriter prints the correct character.

The interface should next be connected to the computer RS232 port and powered up, preferably from an independent 5V

supply. Press S₁ to reset IC₁₀, ensure that the led goes out and the CTS line to the computer goes high. A short program loop should be written to send a continuous stream of characters to the interface. Do not forget that it will be necessary to configure the computer for the correct baud rate. The row outputs from the interface

should be monitored to ensure that the appropriate row is pulsed low (use an oscilloscope or else a led in series with a 390Ω resistor to +5V). Check each row in turn by sending an appropriate character to select each one.

The interface should now be connected to the typewriter. Data should be sent by

the computer to test the entire character set.

The computer should be configured to output both carriage-return and line-feed characters whenever a new line is required. To check the sequence of the carriage-return and line-feed characters, position the print head at the right hand margin and send the typewriter a return signal from the computer. Check that the print head returns to the left margin before a line-feed takes place. If the line-feed occurs first, then link 5 should be changed (see Table 1). Led₁ should flash during the carriage-return period and computer output should be halted.

Finally check that the paper-out circuit is operating correctly by ensuring that the led lights and the CTS line goes low at the end of the line following a paper-out condition being detected.

Modifying the typewriter

To attach the ribbon cable to the typewriter it is necessary to remove the typewriter top cover and the keyboard assembly. The pivoting cover on top of the typewriter should first be removed by swinging it upward and springing one of its ends away from the retaining bar on to which it is clipped. The other end can then be unclipped and the cover removed. The knobs on either end of the platen roller should then be removed by unscrewing them.

Next the four top cover retaining screws should be removed from the underside of the typewriter and the top cover taken off. Undo the two retaining screws at either side of the keyboard and lift the keyboard assembly away, taking care in the process to unplug the cables from its underside. The cable connectors are easily distinguished so there is no need to mark them for later re-assembly. The keyboard assembly consists of two circuit boards folded together and held apart by three spacers. The three nuts that fasten the circuit board to the spacers should be removed and the keyboard assembly unfolded. The ribbon cable should now be soldered to the main circuit board as shown in Fig.4 so that it emerges from between the two boards when they are folded together again. During re-assembly, take care to position the flexible ribbon to the print head so that it is not under tension when the head is at the extremes of its travel. It is necessary to cut away some projections on the inside of the top cover to prevent damage to the cable when the cover is refitted.

WW

Praxis typewriters are available through Wilding Office Equipment and other Olivetti dealers at around £260 for the Praxis 30 and £290 for the Praxis 35. Programmed eproms are available from the author at 18 Carnoustie Gardens, Glenrothes, Fife KY6 2QB for £9.60 each including postage and v.a.t. The other components can be obtained as a kit from Technomatic Ltd.

Table 2: Eprom converts data received by the uart into a code to select the typewriter keyboard rows and columns via multiplexer and de-multiplexer. Table shows data and typewriter response to each incoming ASCII code. Data for eprom locations 80 to FF is identical to data in locations 00 to 7F with the exception of location 8A with data 36 and location 8D with data B7.

Addr	Data	Char	Addr	Data	Char	Addr	Data	Char	Addr	Data	Char
00	00		20	3E	Spc	40	44	@	60	46	f
01	00		21	3E	Spc	41	61	A	61	21	a
02	00		22	42	"	42	56	B	62	16	b
03	00		23	3E	Spc	43	7B	C	63	3B	c
04	00		24	3E	Sp	44	63	D	64	23	d
05	00		25	51	%	45	5B	E	65	1B	e
06	00		26	5E	&	46	64	F	66	24	f
07	00		27	75	'	47	7D	G	67	3D	g
08	2E	B.Spc	28	74	(48	4E	H	68	0E	h
09	07	Tab	29	73)	49	6C	I	69	2C	i
0A	B7	Express	2A	41	*	4A	4D	J	6A	0D	j
0B	00		2B	69	+	4B	4C	K	6B	0C	k
0C	00		2C	13	,	4C	4B	L	6C	0B	l
0D	36	Return	2D	32	-	4D	54	M	6D	14	m
0E	00		2E	12	.	4E	55	N	6E	15	n
0F	00		2F	43	/	4F	6B	O	6F	2B	o
10	00		30	33	0	50	6A	P	70	2A	p
11	00		31	01	1	51	59	Q	71	19	q
12	00		32	02	2	52	5C	R	72	1C	r
13	00		33	03	3	53	62	S	73	22	s
14	00		34	04	4	54	5D	T	74	1D	t
15	00		35	06	5	55	6D	U	75	2D	u
16	00		36	05	6	56	7C	V	76	3C	v
17	00		37	1E	7	57	5A	W	77	1A	w
18	17	½ Spc.	38	35	8	58	7A	X	78	3A	x
19	0F	M.Rel.	39	34	9	59	65	Y	79	25	y
1A	1F	M.Left	3A	4A	:	5A	79	Z	7A	39	z
1B	27	M.Right	3B	0A	;	5B	3E	Spc	7B	3E	Spc
1C	2F	Tab set	3C	3E	Spc	5C	3E	Spc	7C	3E	Spc
1D	3F	Tab clr	3D	29	=	5D	3E	Spc	7D	3E	Spc
1E	28	S.Lock	3E	3E	Spc	5E	3E	Spc	7E	3E	Spc
1F	30	Repeat	3F	72	?	5F	45	-	7F	10	Del

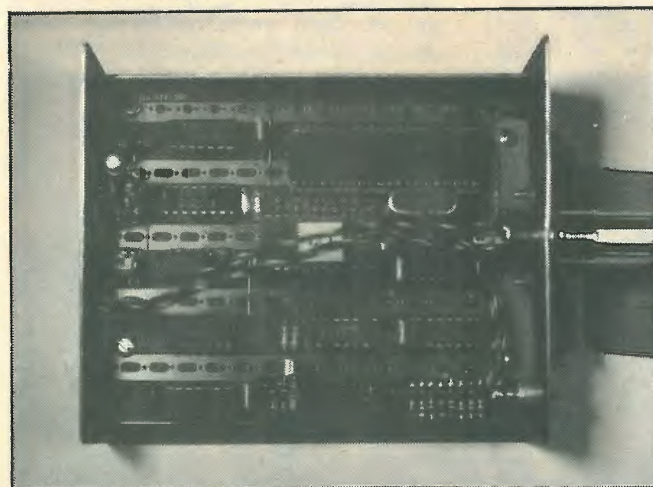

Aerial inefficiency at sea

Innovation in marine aerals is badly needed: British thought in this area has been 'fossilized' for 50 years. But North Atlantic sea trials earlier this year of new British-designed components have shown 'excellent results.' This is the third of John Wiseman's startling revelations on the state of marine aerals.

by J. J. Wiseman

We at sea are not the only people who have been forced by an unfavourable environment, to operate low-frequency transmitters into aerals less efficient than the textbook optimum. The photograph on this page shows a trench transmitter of the First World War, operating on wavelengths between 500 and 2000 metres with an aerial only a metre above the ground, and a range of 3 or 4km. With an aerial of specified 40 foot length and 15 foot height,

range was up to 80km. Even from this inadequate aerial, a useful service was still obtained, even more remarkable considering the primitive receivers of those days. Other 1914-18 War transmitters worked

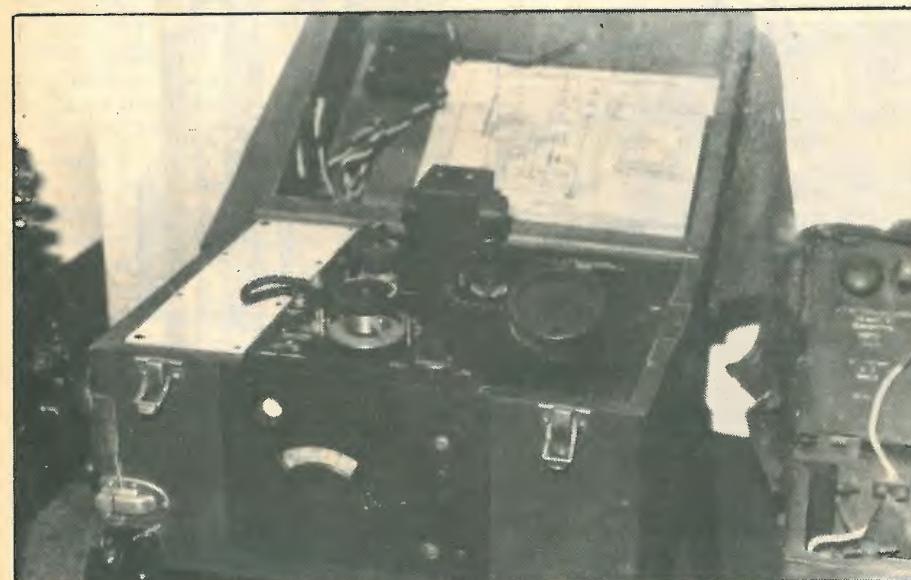

Fig. 1. This l.f. trench transmitter operated into an aerial only a metre above ground, but others worked from aerals inside the trench. (20watt Mk 3 transmitter, 1917, has single-valve tuned-anode oscillator, but a second valve could be switched in parallel for maximum power. HT supplied by 1,000-volt battery or induction coil.)

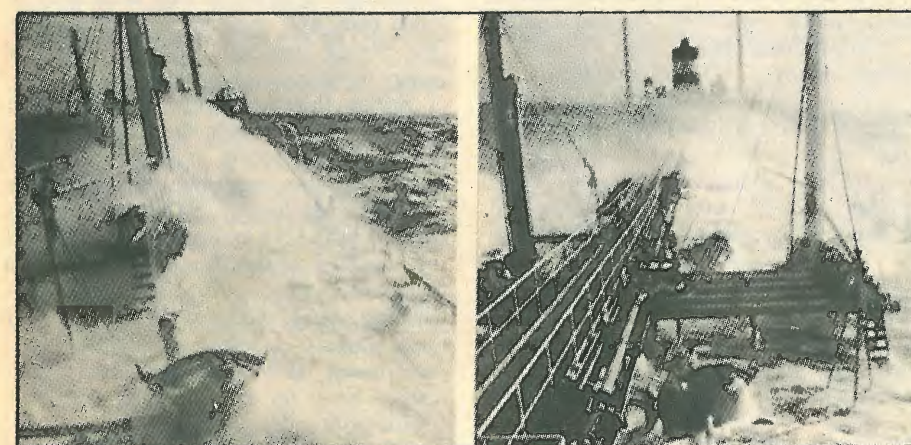

Fig. 2. Those whose experience of a storm at sea is a rough ride to Calais on a stabilized passenger ferry can have little idea of the force of a North Atlantic winter gale. (Photo: P. F. Barber, Scarborough)

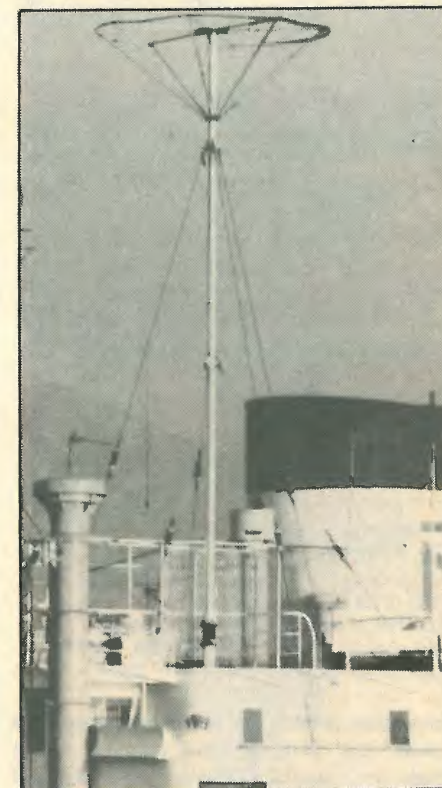

Fig. 3. Top-loaded unipole aerial of Scandinavian origin. The stays add to the top capacitance, also to the leakage. Has little height. (Photographed at Eleusis, Greece, 1982)

into aerals actually *inside* the trench, below ground level, operating at 80 to 100 metres wavelength.

The efficiency of the 500kHz marine aerial depends, as for any other other, on its height and dimensions; the special variable factor in the marine environment is leakage. A correspondent (WW February 1983 issue) has pointed out that an aerial height of 0.1λ, at perhaps 40 or 50% efficiency is about the least we can hope to get away with, and at 500kHz this corresponds to 60 metres, an impossible height. But according to a BBC Research Department report by H. Page, published in 1963: "... a capacitive top is often added to a low aerial with the object of increasing the radiation resistance. In this case, a large top changes the current distribution on the vertical portion of the aerial from linear to substantially constant, thus approximately quadrupling the radiation resistance ...". This might lead to the

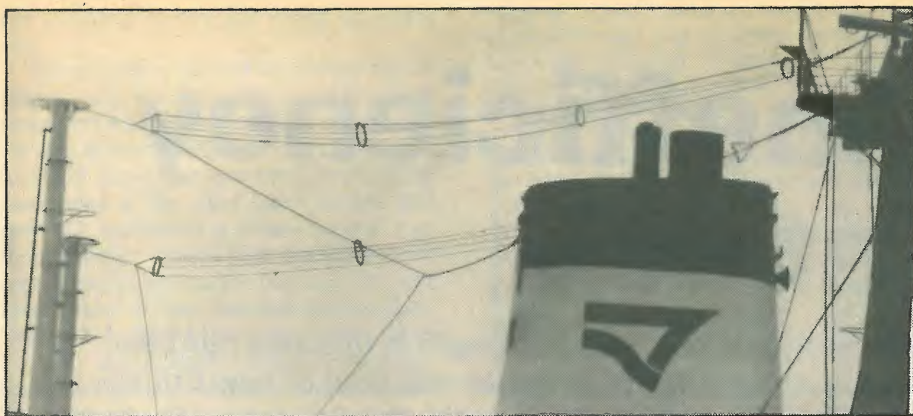

Fig. 4. Hard-to-find classic French all-wire sausage aerials with high top capacitance, well sited on available structures. ('Dumont d'Orville,' French flag, b.1977, 23910 g.r.t. photographed at Cr. Couronne, 1983.)

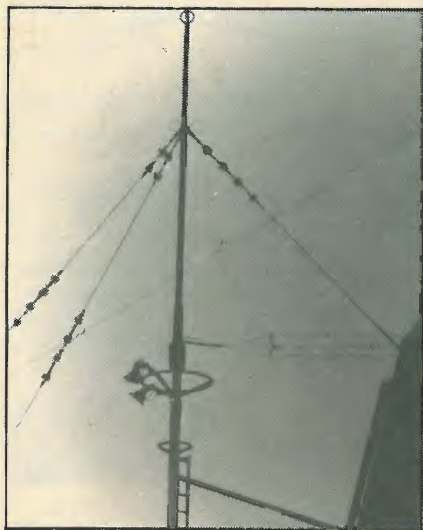

Fig. 5. This stubby mast accounts for 5% of aerial capacitance, 2% of its radiation, and 90% of its cost! It makes no economic or functional sense. Cargo cult design. ('Ile de la Reunion,' French flag, b.1969, 16671 g.r.t. photographed at Rouen, 1983.)

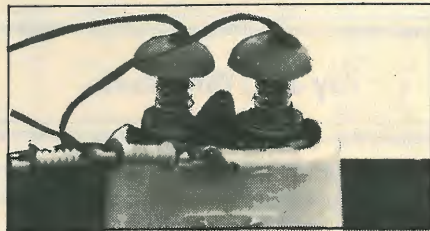

Fig. 6. Traditional British feedthrough set-up, unchanged since the days of silent movies, photographed in 1983.



Fig. 7. Abbreviated version for a quick, cheap job on a 900-ton supply vessel failed repeatedly at sea. (Australian flag, photographed in Tasmania, 1976.)

hope that, with a good capacitive top, one could work with an aerial only 15 metres high with useful efficiency. We will get some lift over ground-level figures because the base of the aerial is already well elevated by the hull of the ship. Figures 3 & 4 show about the least and the most that can be done about 'tops' on an average ship. The bizarre arrangement in Fig 5 has all the correct ingredients, but has got them upside down: the money has been invested in the wrong end of the aerial. As well as improving radiation resistance, the 'top' improves the L/C ratio, minimizing arcing. As manufacturers keep on supplying transmitters specified to match aerials of "250 to 750pF", and shipyards tend to supply aerials toward the lower end of the 80 to 400pF range, the 'top' can only help, avoiding tuning difficulties particularly at the low end of the 405 to 535kHz band.

If the RC product is too small, charge put into the aerial each cycle may leak away almost as fast as it can be supplied (R is parallel leakage). Time between peaks is longer at lower frequencies. This is a further good reason for making C as large as possible. But what can be done about R?

The standard British feedthrough insulator arrangement, unchanged since 1930, is at its best and at its worst in Figs 6 and 7. The strain insulators are also standard British issue. Their presence adds to

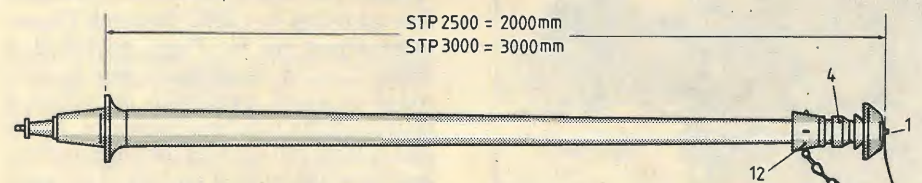

Fig. 8. German 10-foot-tall glass-fibre feedthrough trunk shown on its side. Intelligent design, efficient and unobtrusive. Requires no safety fencing. Might benefit from a few rain cones along the shaft. Dieckmann & Klapper, Gerätebau GmbH, Hamburg.)



Fig. 9. Simple and effective conical skirts of common British telegraph pole insulators, in use for nearly a century, and only now recently adopted for marine use, Figs. 10 and 11.

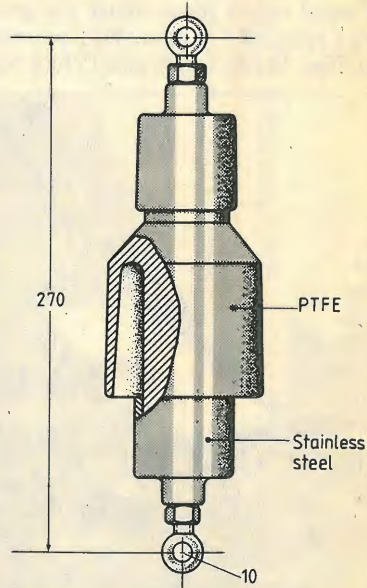

Fig. 10. Tough German aerial strain insulator using skirt principle. Rated at 50kV (dry) at 500kHz. 700kg tensile load, mass 1.5 kg. (Dieckmann & Klapper.)

leakage, and cancels any useful effect the bells might have. In earlier times the trunking (Fig 6) would have been made of oiled teak, and could have contributed to the overall insulation. These days it is soggy plywood, even steel.

British thought in this area has been fossilized for 50 years; there has been reluctance to innovate or to produce any aerial hardware requiring much manufacturing. Books like "101 Things a Boy Can Make" have a lot to answer for. The ends of this kind of feedthrough insulator are sometimes unglazed and porous, absorbing water, and usually sealed with cork washers. A British firm makes a solvent-based silicone preparation which causes water on the surface of a ceramic insulator to collect in small drops, preventing formation of a conductive film. It requires oven curing. I have never seen it used at sea; it could be useful. The old 'bitumastic strap' insulator, a yard-long

tough rubber thong, worked on this principle, although it might have fried at 17MHz!

A German-made feedthrough trunk, based on a tough glass-fibre tube, is up to three metres long (Fig 8); polyester stays are available to brace it. There is minimal shunt capacitance, small surface area, and a long way indeed to leak or arc. It is rated at 30kV at 500kHz. A neat arrangement: beats soggy plywood, and probably doesn't cost much more.

The insulator shown in Fig 9, with its deep skirt, has been on British telegraph poles for nearly 100 years — simple and effective. Only recently has a German firm adapted the principle to insulators for marine use, Fig 10. The same idea is seen again on the base of a Russian mast aerial in Fig 11. Why has it taken so long?

The feedthrough insulator of Fig 12, with metal jacket and metal rain cone, was photographed on the British cruiser, HMS Belfast. If the Navy had advanced ideas, they did not seem to get passed on to the merchant fleet.

But British ingenuity, neglected as it may be, is still very much alive and well, and living in Britain.

Recently patented, British developed feedthrough and aerial link insulators (Figs 13 & 14) with protective mantles of elegant design have undergone testing by a national h.v. laboratory and sea trials in the North Atlantic in winter with excellent results, see Fig 15. The shrouding domes are made of transparent high impact plastics. The feedthrough unit is held to the bulkhead by non-metallic nylon bolts, and a stream of air blown into the inner dome to prevent penetration by moisture, warmed as well if necessary to prevent icing. The link insulator unit has a vaned, wind-driven rotating outer dome, running on non-metallic rollers. Water entering is thrown out through small holes in the rotating part. With salt-water spray directed into the gap between inner and outer domes for 30 minutes in laboratory tests, flashover occurred at 57kV. An unprotected insulator under similar conditions began to spark over at 11kV.

In North Atlantic sea trials, carried out on a British tanker from late January to early April, one aerial retained its British 'standard' brass bell fitted feedthrough, the other being supplied with the domed shrouding mantle assembly. The day-to-day log kept shows typically an equal 4A up either aerial in dry weather, but 'tuning impossible' with the standard aerial in bad weather, while the modified aerial was still drawing a good 2.8A, from the same 100watt transmitter at 500kHz. Later, link insulators with protective mantles were added to that aerial, with further improvement in results. While the standard aerial drew only 0.5, the modified aerial took 3.9A. What more can man do? Perhaps combine the best features of several of the systems described, no more. WW



Fig. 11. Base of Russian mast showing three deep-skirted rain cones on the central glass-fibre pole. (Photographed at Rouen, 1983.)



Fig. 12. Metal-jacketed naval feedthrough insulator on HMS Belfast, World War 2 cruiser, now museum. Plumbing suggests it might have been air blown.



Fig. 13. Recently-developed British feedthrough assembly with dual-domed protective mantle. Moisture is expelled from domes by air blower. (By P. F. Barber, Scarborough.)

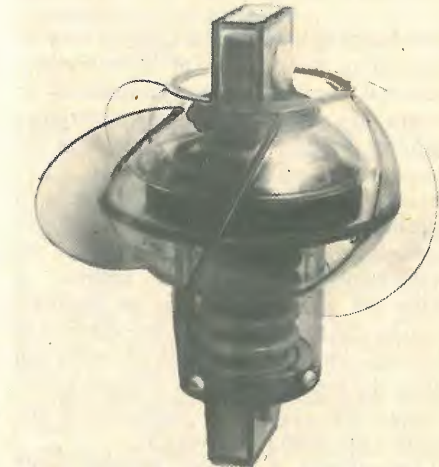

Fig. 14. British invented link/strain insulator assembly with protective shrouding. Wind-driven rotating outer dome expels water by centrifugal action. (P. F. Barber, Scarborough.)

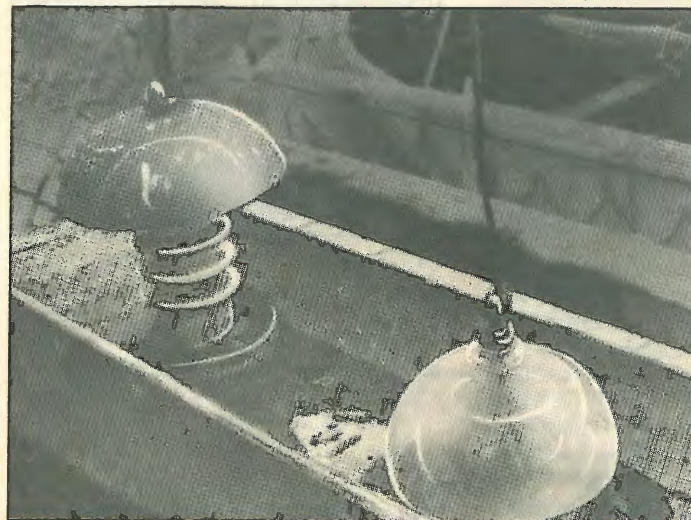

Fig. 15. Sea trials with one feedthrough protected, the other traditional. In later trials protected link insulators added.

In bad weather at 380 miles, on 500kHz, US coastguard gave (typically) QSA1 from traditional side, QSA4 from protected side, same transmitter. Had the usual shunting strain insulator been present traditional side would have fared even worse. (P. F. Barber, Scarborough.)

Loudspeaker measurements simplified

Acoustic measurement techniques designed to avoid the vagaries of personal prejudice and room acoustics normally require a calibrated microphone. Using the principle of reciprocity three transducers can be calibrated with reasonable accuracy and no specialized equipment

by Peter F. Dobbins

The design of loudspeaker cabinets may be reduced to the analysis of an equivalent electrical circuit¹. In principle it should be within the capabilities of an electronics engineer to devise his own speakers for special applications, or simply as a less expensive and/or better quality option to commercial offerings. Problems arise however when attempting to confirm the performance of the finished product. A subjective listening test may be adequate in some circumstances, but the vagaries of personal prejudice and room acoustics can affect the results, and it is difficult to determine the cause of a fault should the speaker not sound satisfactory.

The subject of acoustic measurements has been discussed previously in *Wireless World*. Hiscocks² described a gated tone-burst method of eliminating the effects of reverberation and echoes, and Grubb³ showed how a fast Fourier transform spectrum analyser might be used to achieve the same end. But before such sophisticated signal processing can be applied the acoustic field must be measured. This implies the use of a microphone of known sensitivity and response, probably not available to the home constructor. An application of the principle of reciprocity is described in this article which leads to the absolute calibration of three transducers by means of purely electrical observations.

The three transducers required are a transmitter, a receiver and a reversible device. Most forms of acoustic transducer in general use are reversible, and the method is admirably suited to the calibration of a microphone and a pair of loudspeakers.

The reciprocity theorem states that in a passive linear four-pole network the ratio of excitation to response is constant when the positions of excitation and response are interchanged. But more particularly, the two open-circuit transfer admittances are equal.

Two reversible electroacoustic transducers coupled to the same medium and accessible only through the two pairs of electrical terminals form a four-pole network. A general proof of the validity of the law has not been given for this case, to my knowledge, but it has been proven for special cases. Furthermore, in practice it is easy to check that a particular network is reciprocal, as described, and for this reason the validity is assumed. It is further assumed that the principle applies to individual transducers. Consider Fig. 1(a), which shows a current i_1 flowing into terminals 1 & 2 of a network causing an open-circuit voltage e_1 to appear across terminals 3 & 4. In (b) the connections are reversed, and an input current i_2 at terminals 3 & 4 causes an open-circuit output voltage e_2 at terminals 1 & 2. Reciprocity may be stated as

$$i_1/e_1 = i_2/e_2 \quad (1)$$

In a transducer terminals 3 & 4 may be regarded as a point in the acoustic medium

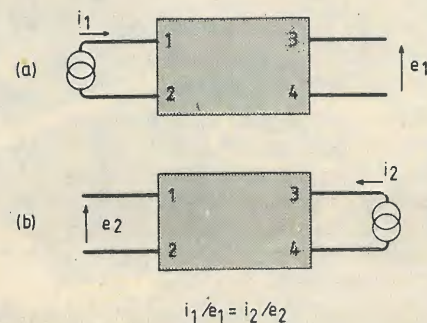

Fig. 1. Four-port network is reciprocal if its transfer admittance is the same in both directions.

at a distance r from the device. Network (a) represents a transmitter or loudspeaker. An input current i produces a sound pressure p at the output. Network (b) represents a receiver or microphone and an acoustic source of strength Q at the input produces an open-circuit voltage e_o at the output terminals. Equation 1 may then be written:

$$i/p = Q/e_o \quad (2)$$

For those unfamiliar with acoustic terminology, the rate of flow in the medium from source is

$$Q(t) = \int_A u(t) \cdot dA$$

where A is the area of the vibrating surface and $u(t)$ is the velocity of that surface. Generally, for simple harmonic motion

$$Q(t) = Qe^{j\omega t}$$

where Q is the strength of the source. At low frequencies a loudspeaker cone may be regarded as a rigid piston, and the source strength is simply the effective area multiplied by the cone velocity. The acoustic pressure p at a distance r from this source is inversely proportional to r , if spherical spreading is assumed, and related to Q by the equation

$$p(t) = \frac{j\rho ck}{4\pi r} Qe^{j(\omega t - kr)} D(r, \theta, \phi)$$

ρ is the density of the medium, c is the sound speed, $k = \omega/c$ is the wave number or spatial frequency, and D is a function describing the directivity of the source with arguments r, θ, ϕ in spherical co-ordinates. For this discussion directivity is neglected, as once the sensitivity has been found in the straight-ahead direction it is a simple matter to rotate the source and measure the relative response in other directions and so determine the beam pattern. Phase angle may be retained in these calculations but is generally neglected because of exper-

imental difficulties encountered in accurately determining both the distance between transducers and the sound speed in the medium, so only the amplitude is considered here. Thus D is set equal to one, and the exponential time dependence may be dropped:

$$p = \frac{\rho ck}{4\pi r} Q \quad (3)$$

where p and Q are r.m.s. amplitudes. Both spherical radiation and free-field conditions are implicit in equation 3, and the consequences of these assumptions will be discussed when the practical application of this theory is considered.

The free-field voltage sensitivity m of a transducer used as a microphone is the ratio of the open-circuit voltage output e_o to the free-field sound pressure p :

$$m = e_o/p \quad (4)$$

The transmitting voltage (or current) response, $s_v(s_i)$, of a transducer used as a speaker is the ratio of the sound pressure at unit distance from the transducer to the voltage applied across (or the signal current flowing into) the electrical input terminals:

$$s_v = p/v \text{ or } s_i = p/i \quad (5)$$

Combining equations 3 & 4:

$$m = \frac{4\pi r e_o}{\rho ck Q} \quad (6)$$

From equation 5 and the reciprocity relationship (equation 2):

$$Q = e_o/s_i$$

$$m = \frac{4\pi r s_i}{\rho ck} \quad (7)$$

Thus, substituting for Q in equation 6,

Noting that s is defined for unit distance (i.e. $r=1$), and that k may be expressed in terms of frequency, $k=2\pi f/c$, equation 7 becomes

$$\frac{m}{s_i} = J = \frac{2}{\rho f} \quad (8)$$

where J is the reciprocity parameter or acoustical transfer admittance for spherical radiation. By modifying the form of equation 3, reciprocity parameters may be derived for other conditions, such as plane waves, and examples will be found in reference 5. Equation 8 is derived from MKS units and if other systems are used a conversion constant must be included. A note on units used in acoustics is given in the Appendix.

As engineers prefer everything in logarithmic form so that they can add and subtract rather than multiply and divide, equation 8 may be re-written

$$S = M + 20 \log f + 20 \log \rho/2 - 20 \log |Z|$$

where $S = 20 \log s_v$ (dB relative to 1 Pa/V at 1 m), $M = 20 \log m$ (dB re 1 V/Pa), and $|Z|$ is the input impedance of the transducer (only the magnitude is needed as only the magnitudes of M and S are to be found).

Finally, taking the density of air as $1.2 \text{ kg} \cdot \text{m}^{-3}$, a new reciprocity factor K is defined by

$$S = M - K \quad (9)$$

$$\text{with } K = 20 \log |Z| - 20 \log f + 4.4 \quad (10)$$

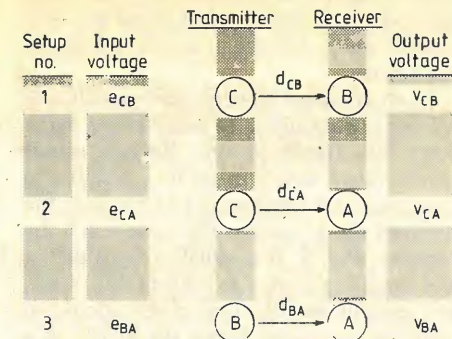

Fig. 2. Schematic three transducer reciprocity calibration. Drive voltage e_{CB} is applied to transducer C, which transmits to transducer B, at a distance d_{CB} , giving an output voltage v_{CB} . Test is repeated with C transmitting to A and B transmitting to A.

Three transducer method

The practical application of reciprocity in acoustic calibration requires three linear transducers, of which at least one is reversible, and also that measurements be carried out under free-field conditions and in the far field of each transducer. These conditions must be met if results are to have any meaning, and some simple checks are described in the section on measurement techniques.

The three transducers required are a microphone A, a reversible device B and a speaker C. The terms microphone and speaker refer only to the usage of the transducer for these tests, and the term transducer is taken to mean any device that converts acoustic energy to electrical energy or vice versa. A transducer is reversible if the conversion operates in both directions, and this is true of almost any device that contains no active components, obvious examples being the ordinary moving coil loudspeaker and dynamic microphone.

Both transmit and receive sensitivities may be obtained for all three transducers under test by full use of reciprocity. Three sets of measurements are done:

- speaker to reversible device
- speaker to microphone
- reversible device to microphone

The sequence is shown schematically in Fig. 2. Assuming spherical spreading, the relationship between drive voltage and received voltage for a test between transmitter I and receiver J is

$$e_{IJ} = \frac{v_{IJ} m_I s_J}{d_{IJ}}$$

or in logarithmic form and with some rearrangement

$$A_{IJ} = D_{IJ} - S_I - M_J \quad (11)$$

where $A_{IJ} = 20 \log (v_{IJ}/e_{IJ})$ is attenuation and $D_{IJ} = 20 \log d_{IJ}$ is spreading loss. The relationship between M and S for one transducer is given by equation 9 as $S_I = M_I - K_I$, where K is the reciprocity term from equation 10.

The three sets of measurements give

$$A_{CB} = D_{CB} - S_C - M_B \quad (12)$$

$$A_{CA} = D_{CA} - S_C - M_A \quad (13)$$

$$A_{BA} = D_{BA} - S_B - M_A \quad (14)$$

Combining the first two by eliminating S_C gives

$$M_A = D_{CA} - D_{CB} + A_{CB} - A_{CA} + M_B$$

But $M_B = S_B + K_B$ and substituting for S_B from the third equation leads to

$$M_A = 1/2(D_{CA} - D_{CB} + D_{BA} + A_{CB} - A_{CA} - A_{BA} + K_B)$$

The receive sensitivity of the microphone has now been found in terms of distances and electrical quantities by use of the reciprocity factor. The rest is plain sailing. Using equations 13 & 14

$$S_C = D_{CA} - A_{CA} - M_A \text{ and}$$

$$S_B = D_{BA} - M_A - A_{BA}$$

and by reciprocity:

$$M_B = S_B + K_B.$$

The transmit sensitivity of the speaker and both transmit and receive sensitivities of the reversible device are now known. The speaker and microphone may not be reciprocal. For instance, an electret microphone usually has a built-in preamplifier so is obviously not reversible, and as the terminals of the transducer are not directly accessible the impedance cannot be calculated. However, if either or both of these transducers are reversible the remaining sensitivities are easily found:

$$S_A = M_A - K_A$$

$$M_C = S_C + K_C.$$

These last six equations give absolute calibrations for each of the transducers, obtained without a reference transducer. The measurements and calculations must be repeated at each frequency of interest, and at first glance the process may seem tedious. But the amount of experimental work is no greater than carrying out three separate frequency response procedures using a standard transducer, while the calculations are simple arithmetic and easily programmed for a computer or calculator. If practicable, some easing of the workload can be achieved by making distances and drive voltages constant for all tests.

Measurement techniques

Before the calibration procedure can begin the impedance of each transducer must be found as a function of frequency so that the reciprocity factor can be calculated. If a bridge is not available the simple circuit of Fig. 3 generally provides satisfactory results. To keep errors low, R should be a low resistance ($R < |Z|/100$) if the transducer is a high impedance device, and the impedance obtained from $|Z| \approx V_1 R/V_2$. If the transducer is a low impedance device then R should be a high resistance ($R > 100|Z|$) and the impedance obtained from $|Z| \approx V_3 R/(V_1 - V_3)$.

Most transducers have very low electro-mechanical coupling coefficients so no special precautions need be taken, provided the active face is not pointing directly at a nearby reflecting surface. Some devices such as piezoelectric tweeters are very efficient, and any obstacle within several wavelengths may affect the measured impedance. A sensible procedure is to suspend the transducer in mid-

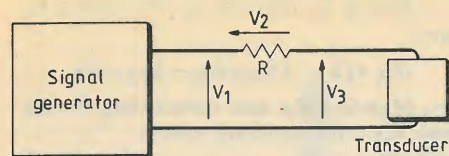

Fig. 3. In the absence of a bridge the input impedance of a transducer may be determined by measuring the voltage drop across a series resistor.

air, allowing it to swing freely. If the impedance does not appear to change as the device moves then all is well. Transducers such as tweeters, whilst not requiring a cabinet for their operation, should be mounted as they will be in service, because the presence of baffle will affect both impedance and sensitivity at frequencies where the device is small compared with the wavelength.

The basic measurement set-up is shown in Fig. 4. The hardware need not be sophisticated, but before discussing the instrumentation the acoustic environment and the necessary conditions must be considered.

Measurements should be made in the far-field of the transducers, which means that the projector is assumed to be a point source from which spherical waves spread, and the receiver is assumed sufficiently small that the wavefront may be considered plane over the transducer face. As both have finite size there must be sufficient distance between them before the assumption can be considered valid. For a working rule the minimum distance should be a^2/c or 5λ , whichever is the greater, where a is the maximum dimension of the larger transducer and c is the sound speed. In air, $c=343\text{ms}^{-1}$. The size should include the housing, not just the active face of the transducer, as any discontinuity can act as a secondary source.

The free-field condition is generally the most difficult to deal with, and essentially means that the sound waves must be free to radiate spherically with no disturbance by boundaries or obstacles within the field of interest. In principle the receiving transducer should not distort the wavefront, but there is little that can be done to ensure this, given a particular device. There are a number of ways to tackle the free-field problem:

- 1 - measure in an anechoic chamber
- 2 - measure out of doors
- 3 - use pulse techniques
- 4 - measure in a room and correct for reverberation by calculation or signal processing
- 5 - measure in a room and ignore room effects.

The effect of reverberation is to introduce ripples into the measured frequency response. If the ultimate in precision is not required it is generally possible to estimate the mean level, and (5) may prove satisfactory. An anechoic chamber is not usually available, so weather permitting, (2) may be the best compromise. Solution (4) usually requires specialized instrumentation or vast computing power, but an interesting discussion of a typical tech-

nique is given in reference 6. The pulse method (3), is described in detail in references 2 and 3, but the principle is summarized here.

In an enclosed environment signals travel from transmitter to receiver by paths other than the direct one. Because sound travels fairly slowly in air it is possible to transmit short tonebursts and measure the received signal before reflections reach the receiver, Fig. 5. It is usual to use a gating and sampling system to achieve this result, but careful oscilloscope observation can result in accuracies better than 0.5dB. If a gated signal generator is not available, a simple fet switch can be constructed, as described in reference 2.

Maximum pulse length is determined by the difference between direct and first reflected path length. The minimum pulse length is determined either by the rise-time (and therefore the bandwidth) of the transducers or by the time constant of the detector. As frequency becomes lower a longer pulse is needed to encompass a sufficient number of cycles, and the method becomes unuseable when the wavelength approaches the differences between direct and reflected path lengths. In average-sized rooms this is typically around 500Hz. The maximum pulse repetition rate is determined by the time it takes for reflections to decay to negligible amplitude. These times may be calculated, but are easily set empirically by direct observation of the signals.

Free-field and far-field conditions are easily checked by confirming compliance with equation 3. If the transmitter is driven at constant frequency, constant voltage, and the receiver output voltage measured as a function of distance, this voltage is then inversely proportional to distance.

The total transmission chain should be linear, with no saturation effects. It is not generally appreciated that the acoustic medium itself may become non-linear at high pressure amplitudes, especially at high frequencies or when the transmission path is constricted as in a horn. Testing for proportionality between transmitter drive voltage and receiver output will check for both linearity and an adequate signal-to-noise ratio.

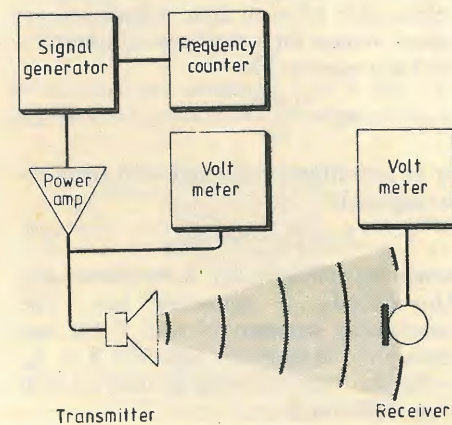
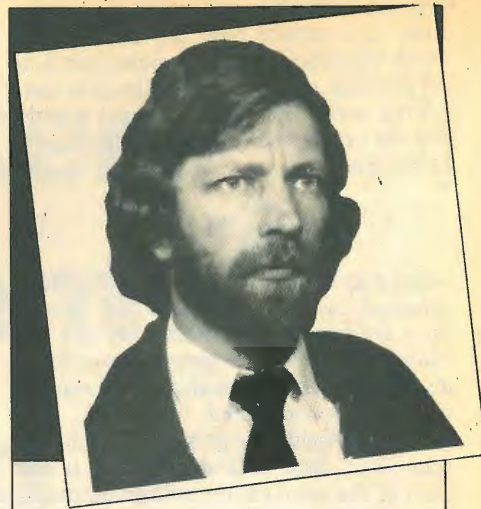

Fig. 4. Minimum instrumentation is a signal generator and suitable power amplifier, a frequency counter and a means of monitoring the transmitter drive level and receiver output voltage.



Peter Dobbins began his career as a technician apprentice with BAC, Hurn, obtaining a City & Guilds qualification in aeronautical radio and instrumentation at day release and evening classes. His first professional contact with acoustics was at Ultra Electronics, Greenford, where he worked on the development of transducer arrays for sonobuoys. He joined BAe at Weymouth (formerly Sperry Gyroscope) in 1976 to work in electronics design, but transferred to the underwater technology department in 1981. Since then he has gained an honours degree in applied mathematics from the Open University, and has recently been elected a member of the Institute of Acoustics. In 1982 he became a founder member of a specialist transducer group at BAe, and is now a senior engineer working on underwater acoustic transducer and array design, with interests in long-range propagation and non-linear generation of low frequency sound.

Reciprocity must also be confirmed. It is not possible to check that the individual transducers are reciprocal without direct measurements on the acoustic field, but it is possible to test the combined transmitter/receiver chain, simply by measuring the transfer admittance in both directions. With two transducers in their final measurement positions drive one, noting the input current i_1 and measure the output voltage e_1 from the other. Reverse the connections and measure the new input current, i_2 , and output voltage, e_2 . This should be repeated at a number of frequencies over the range of interest. If $i_1/e_1 = i_2/e_2$ at each frequency, then both transducers may be regarded as reciprocal.

Making the calibration measurements is straightforward. It is assumed that continuous rather than pulsed signals are being used and that some suitable location has been found, perhaps out of doors, enabling free-field and far-field conditions to be met. Typically the transducers under test will be two loudspeaker drivers and a microphone, one of the speakers being used as the reversible device, taking care to distinguish between the two speakers.

The first job is to select the frequencies to be used, and common practice is to have third-octave steps, the sequence being 1,

1.25, 1.6, 2, 2.5, 3.15, 4, 5, 6.3, 8, 10 etc. This is not essential, the point being to keep to the same frequencies for each set of measurements.

The speaker and reversible device should be positioned, pointing directly towards one another, at the appropriate free-field distance and as high above the ground as possible to reduce the effect of reflections. The distance between the transducers should be measured. Measure from the diaphragm, if exposed, otherwise from the plane of the baffle or front of the mounting structure.

Instrumentation is set up as in Fig. 4, using the speaker as transmitter and reversible device as receiver in the first test. There are no special requirements of the signal generator and three-digit accuracy is adequate for the frequency counter. The power amplifier could be one channel of a hi-fi unit, and to get the best signal-to-noise ratio the drive level should be as high as possible, subject to linearity, transducer power handling and complaints from neighbours.

One point about the detector. The theory described here applies specifically to open-circuit output voltage, so the detector input impedance must be much greater than the output impedance of the transducer or results will be meaningless. It is not necessary to have separate instruments to measure transmit and receive voltages, but it does make the work less complicated.

Once the equipment is operating satisfactorily the drive voltage and received voltage must be noted at each frequency of interest. This procedure is then repeated with the speaker as transmitter and microphone as receiver, and finally with the reversible device as transmitter and microphone as receiver. The required sensitivities can then be calculated from equations.

Results

Repeated and careful reciprocity measurements can result in a sensitivity accuracy of 0.5dB or better, but real life acoustics is not that exact. The transducers themselves are not particularly stable. Their sensitivity will certainly vary with temperature. More importantly, the radiation resistance is proportional to the density of the air and the speed of sound, both of which can change with temperature pressure and humidity. This change will be reflected in the input impedance, and

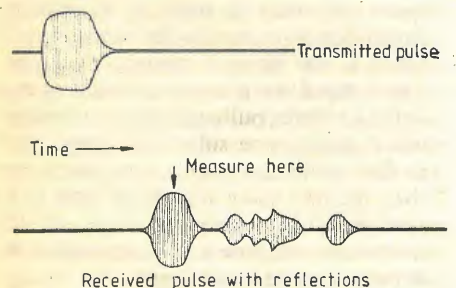

Fig. 5. In suppressing echoes by pulse technique, the transmitted pulse is short enough to allow the received signal to be measured before the arrival of reflections.

with an efficient transducer the impedance term in equation 10 might vary by $\pm 0.5\text{dB}$ over the normal range of meteorological conditions. Additionally, density is included directly in the reciprocity relationship. The density of air can vary from less than 1.0 to over $1.3\text{kg}\cdot\text{m}^{-3}$, which represents an uncertainty in equation 10 of over $\pm 1\text{dB}$.

Another potential source of error, neglected in the theory, is absorption. Generally the dissipation of acoustic energy in air due to mechanisms such as molecular relaxation and viscous losses is low enough to be ignored. At high audio frequencies, however, and under conditions of high relative humidity the attenuation due to absorption may be as high as 1.0dB per metre.

These, and many other imponderables, mean that an accuracy of better than 1 or 2 dB cannot be guaranteed in uncontrolled conditions. This, however, is more than adequate for most domestic applications, where the main requirement is to ensure that the frequency response of a transducer is essentially flat, and that there are no unwanted resonances. It is unlikely that these results can be bettered with a calibrated microphone under similar conditions.

References

1. Leo L. Beranek. (1954 'Acoustics' Ch. 7, 8, 9. McGraw-Hill.
2. P. D. Hiscocks, Measuring transducer directivity *Wireless World*, vol.84, 1978. No. 1512, pp. 61-66.
3. R. N. Grubb. Non-echoic acoustic measurement with the HP 3582A, *Wireless World*, vol.86, 1980. No. 1531, pp. 45-49.
4. L. D. Luker and A. L. Van Buren, Phase calibration of hydrophones, *J. Acoust. Soc. Am.*, vol.70, 1981. No. 2, pp. 516-9.
5. W. R. MacLean, Absolute measurement of sound without a primary standard, *J. Acoust. Soc. Am.*, vol.12, 1940, pp. 140-6.
6. R. B. Randall and J. Hee, Cepstrum analysis. *Wireless World*, vol.88, 1982. No. 1553, pp.77-80, No. 1554, pp. 88-90 and No. 1556, pp. 78-80.

Appendix: units

Rationalized MKS units have been used throughout this article, which is something of a novelty in acoustic circles. In underwater acoustics MKS is in general use, but the Navy sticks by the traditional fathoms, knots, kiloyards, millibars and so on. Hi-fi people seem happy to use a similar mixture, with an annoying habit of quoting sound levels in decibels without stating a reference pressure, and who knows what terms like Noy, Sone and NEF mean, as used by environmental noise and architectural acoustics people.

Conversions between imperial, c.g.s. and MKS units are straightforward, but take care over whether to add or subtract when dealing with decibels. One worth remembering is

$$1 \text{ yard} = 0.9144\text{m} = -0.8\text{dB relative to } 1\text{m}.$$

It is customary to specify air at a temperature of 20°C and at standard atmospheric pressure in defining standards of acoustic intensity, impedance, pressure, and so on. Under these conditions the density of air is $1.21\text{kg}\cdot\text{m}^{-3}$ and the speed of sound is 343ms^{-1} , giving for the standard characteristic impedance of air $\rho c = 415$ rayls. Unless other conditions of temperature and pressure are known to exist in a particular situation, the above values should be used for the solution of problems.

The commonly used reference standard of intensity for airborne sound is 10^{-12} watt m^{-2} , which is approximately the intensity of a 1kHz pure tone that is barely audible to normal human ears. This corresponds to an effective (root mean square) pressure of

$$p = \sqrt{I\rho c} = \sqrt{415 \times 10^{-12}} = 2 \times 10^{-5} \text{Nm}^{-2}$$

The diagram gives the relationships between the most commonly used reference pressures. Although calculations are made much easier by keeping to MKS units

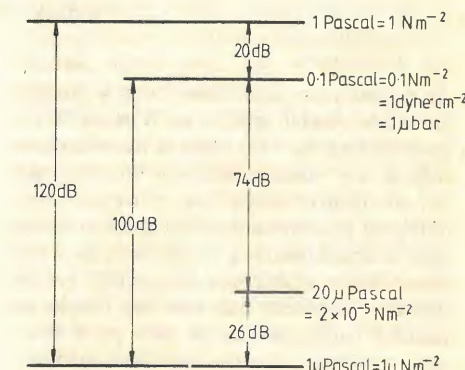

Reference pressure levels in common use and the relationships between them.

throughout the results may be expressed in any convenient units A simple example demonstrates its use. A typical speaker sensitivity would be

$$\begin{aligned} S &= 110\text{dB re } 1\text{Pa/V at } 1\text{m} \\ &= 110 - 26 = 84\text{dB re } 2 \times 10^{-5} \text{Nm}^{-2}/\text{V} \\ &= 110 - 100 = 10\text{dB re } 1 \text{bar/V at } 1\text{m} \\ &= 110 - 120 = -10\text{dB re } 1\text{Pa/V at } 1\text{m}. \end{aligned}$$

A more complicated conversion might be as follows. A loudspeaker manufacturer states that the sensitivity of one of his products is

$$96 \text{ dB at } 1 \text{ yard for } 0.6\text{W input}.$$

Experience suggests that the reference pressure is probably $2 \times 10^{-5} \text{Nm}^{-2}$. If the impedance is nominally 8Ω an input power of 0.6W requires a drive of 2.2V.

$$20 \log 2.2 = 6.9\text{dB relative to } 1\text{V}.$$

The sensitivity is thus

$$S = 96 - 6.9 = 89.1\text{dB rel. } 2 \times 10^{-5} \text{Nm}^{-2}/\text{V at } 1 \text{ yard}.$$

Subtract 0.8dB to refer to 1m

$$S = 89.1 - 0.8 = 88.3\text{dB rel. } 2 \times 10^{-5} \text{Nm}^{-2}/\text{V at } 1\text{m}.$$

And subtract 94dB to refer to 1 Pa

$$S = 88.3 - 94 = -5.7 \text{ dB rel. } 1\text{Pa/V at } 1\text{m}.$$

How to make electric charge from a radio wave

A wave in free space can be persuaded to enter a transmission line where its velocity may be reduced whilst still conserving its field pattern. If the transmission line is formed into a closed circle it may be spun at the same angular velocity as that of the wave to produce an electrostatic field in the laboratory, just as from a charged surface, but the primary energy is entirely in the wave field. Which then is the more fundamental, charge or field – do we really need two criminals where one may suffice?

by R. C. Jennison

In recent years there have been a number of controversial articles in *Wireless World* questioning the very basis of the principles which are fundamental to wireless and wired communication. One is often tempted to comment in the letter columns but it is entertaining to sit back and witness battles which, too frequently, are re-plays of conflicts that one has fought on similar battlegrounds in days gone by. I will not enter directly into the controversies, although it may be clear in which direction my sympathies lie, but I will present a little conundrum and show how a partial solution has been demonstrated with simple apparatus that can be constructed at home by many readers of *Wireless World*.

What is electric charge? What is it made of and why does it have, and appear to behave as the source of, an associated electric field, whatever that may be? If you do not like the concept of an electric field, but prefer to live in my old friend Sandy Scott Murray's particulate world, substitute for the field a horrific flow of virtual photons, whatever they may be. The answer that charge is simply an excess or deficit of electrons, is not sufficiently fundamental. What is the nature of the charge on a single electron? Even if the electronic charge is made of miniscule sub-particles which defy discovery the same question remains: what is charge, is it a special sort of green cheese which acts as the source of an electric field? Its only purpose seems to be to support the field, or complex of virtual photons, and couple it to matter, but after all it is a very old concept that predates Friday's work on fields. At the present time we appear to have two separate unknown criminals who travel hand-in-hand, the electric charge and the electric field. Can we not form a model which causes the two criminals to coalesce and thereby remove at least one of the unknowns?

Start by considering an imaginary exper-

iment using some of the radiation that has been around since the time of the 'big bang'. The 3K radiation which pervades our part of the universe is thought to be the dying remnant of immaculately conceived radiation which cannot be associated with the radiation from particulate matter. We can pick up some of this radiation on a millimetre-wave antenna and pop it down a transmission line in which the velocity of propagation of the disturbance depends on the dielectric properties of the line. In principle the dielectric constant can be as high as we wish so that the disturbance moves at a leisurely pace. (Wave velocity in a transmission line is given by the reciprocal of the square root of the product of the inductance and capacitance per unit length, which is

$$c' = (LC)^{-1/2} = (\mu\epsilon)^{-1/2} = c/(\mu_r\epsilon_r)^{1/2},$$

the same as for an electromagnetic wave in the medium when no conductors are present). Coil the line around so that the circumference is precisely one wavelength in the line, Fig. 1(a). We now have to work very quickly but remember that we are discussing an imaginary experiment at this stage! Chop a section out of the line which carries exactly one wavelength and couple the input of the section immediately to the output of the same section, (b). We now have one wavelength trapped in a continuous transmission line of one wavelength circumference. The radiation will quickly decay but we can at least imagine a transmission line with very low losses so that the wave circulates for a finite time.

You may not care for the idea of changing the connection so quickly, so if you wish to be a little more practical, substitute the arrangement in Fig. 2 where two isolators are used to achieve the same result.

Now take stock of the situation. We have a single loop of transmission line which originally contained no energy other than that associated with its rest mass but which now contains an additional packet of pure electromagnetic energy whose origin can be traced right back to the start of our present universe, about 15,000,000,000 years ago. This energy, in the good old-fashioned concepts of wireless, is in the form of an electromagnetic wave comprising a sinusoidal pattern of electric and magnetic fields which are together in phase and are travelling around the loop at the languid velocity c' . The fields are not coming directly from the electrons in the conductors of the transmission line but these electrons mirror the passage of the wave as they are influenced by the induction from the waves whose origin we have traced. The frequency at which the wave circulates around the loop is the same as that of the original received signal, say 300GHz in round figures, whereas the wavelength is reduced by the effect of the dielectric to only a tiny fraction of its original length.

We are now ready to perform the final trick. Take the little loop containing the wave and spin it, about an axis through its centre, in the opposite direction to that in which the wave is travelling, increasing the speed of rotation until it is rotating anticlockwise at exactly the same angular speed as the wave is rotating clockwise. The trapped wave is now precisely at rest in the laboratory although the transmission line is spinning round at high speed. It is in fact spinning at $-c'$, very much less than the free space velocity of light c , so that from the point of view of the mechanics the principle is demonstrable, as indeed we shall shortly see.

If we now examine the space in close proximity to the little loop we find a static electric field. It is not a standing wave but a truly stationary, unvarying field, the intensity of which is a maximum in one

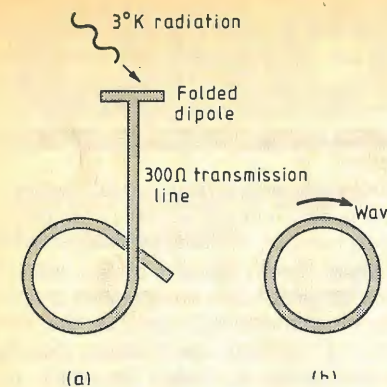

Fig. 1. A wireless wave from the original 'big bang' radiation is picked up on a folded dipole and fed into a 300 ohm transmission line, as shown (a). In principle, the coiled section may be removed and connected full circle whilst the wave is still in the line (b).

direction (say +) in one part of the line, a maximum in the other direction (say -) diametrically opposite and a minimum at the two quadrant points in between. Remember that this is the field that we originally trapped from space and the electrons in the wires are simply slaves to its influence. Relative to the centre of the disc, it is in fact a static dipole field for the particular configuration of the experiment in which both conductors are in the plane of the disc, one of slightly smaller radius than the other. Relative to the laboratory as a whole the vectors are continuous in the upper and lower halves.

Returning to the fundamental point raised at the beginning of this article, we have produced a static field but where are the charges which provide the source of that field? There are none; the electrical energy is the original wave energy and the electronic charges in the conductors are simply catalytic. We have essentially produced a 'charge' from the electromagnetic wave, for one cannot differentiate between the static field that we have produced and another that could be set up by a suitable distribution of 'real' electric charges on a stationary ring in the laboratory.

Practical demonstration

It may well be that you consider that all the above is a lot of academic guesswork and that nothing like it could be achieved in practice. To prove the point I constructed two demonstration systems. One of these uses inexpensive and readily available electronic components and can be built quite easily at home. To this end the frequency is scaled down to the sub-audio range but the apparatus could still, in principle, contain a wave from the virgin past. The apparatus and its implications have been discussed in *Journal of Physics-A* vol. 15, 1982, pp.405-8.

To achieve exceptionally slow velocities of propagation in a transmission line it is usual to increase the permeability and permittivity μ_r and ϵ_r or equivalently to increase the capacitance and inductance per unit length by the use of 'lumped' circuits, in which discrete large values of L

and C are cascaded to form a continuous line of discrete sections. The physical principles in such a line remain the same electromagnetic principles as those in a continuous distributed line which for an equivalent propagation velocity would require impractical values of permittivity and permeability. Phenomenologically, the set of lumped circuits in the apparatus to be described form a dense medium, whereas at low frequencies the molecules in a 'continuous' dielectric behave, on a microscopic scale, as separate systems below resonance.

The arrangement uses a lumped-circuit transmission line in which there are 32 sections giving a total delay of 120ms. The inductors are small 1:1:1 transistor coupling transformers (RS Components) with their windings connected in series to increase the inductance. The capacitors are 1 μ F polycarbonate types from the same supplier. There is a small loss of the order of 1dB in each section of the line and small linear repeater amplifiers are included in the circuit to compensate for this loss. These repeater amplifiers consist of an f.e.t. input stage feeding a bipolar output stage and the gain is set to compensate for the loss in the adjoining section of line. The complete line is looped on itself in a geometrically circular configuration as in Fig. 3.

Energizing the linear repeater amplifiers in the completely closed circular loop causes an oscillation to build up in which a sinusoidal wave with a period of approximately 120ms propagates around the system in a clockwise direction. A slight roll-off in the response of the system, together with the maintenance of just sufficient gain to compensate for the losses, ensures that the waveform remains sinusoidal for long periods. The continuity of the cycling sinusoidal wave places the system in the general category of phase-locked particles*, the particular mode corresponding to one complete wavelength around an annular system. It is possible to inject a signal into the system to initiate the circulation of the wave but one cannot differentiate such a wave from that resulting from self-oscillation, and the last-mentioned serves equally well to demonstrate the phenomenon under discussion.

The whole system is arranged mechanically in a well-balanced configuration on a strong laminated plastics disc, and power to the repeaters is supplied from two small 9 volt batteries strapped symmetrically behind the disc. At the centre of the disc there is a hub which is firmly attached to a small variable speed electric motor.

Upon energizing the repeater amplifiers, a travelling wave moves round the system in a clockwise direction and the travelling field may be sampled at take-off points associated with each of the capacitors. The

* Jennison, R. C. and Drinkwater, A. J. *J. Phys. A.* vol. 10 1977, pp. 167-79. Jennison, R. C. *J. Phys. A.* vol. 11 1978, pp. 1525-33. *J. Phys. A.* vol. 13 1980 pp. 2247-50. Second Oxford Quantum Gravity Conference (London: OUP) pp. 657-69. *J. Phys. A.* vol. 15 1982, pp. 405-8. *Wireless World* vol. 85 1979, June pp. 42-7.

32 elements give a sufficiently close approximation to a continuous line and a reasonably pure sinusoidal wave may be detected passing each of these points. An alternative display system consists of a set of red light-emitting diodes, each of which glows on the passage of the positive crests of the wave, and a set of green light-emitting diodes, each of which glows on the passage of the negative troughs. When at rest the disc then exhibits a circle of rapidly flickering red and green lights corresponding to the circular rotation of the wave system at about 8Hz.

The disc is now spun in an anticlockwise sense at such an angular frequency that it is precisely equal and opposite to that of the wave. At this velocity, the wave, whilst still travelling relative to the disc, becomes stationary in the laboratory. The resulting potentials may be sampled to confirm the stationary state of the field system, but the most vivid demonstration of its state is given by the light-emitting diodes which form two stationary arcs, as shown on the front cover, one of positive (red) and the other of negative (green) potential relative to the centre. With careful adjustment of the speed of rotation, this static dipole electric field may be maintained indefinitely in the laboratory.

It should be stressed that the effect is truly that of a static field and neither a rapidly reversing field, as in standing wave systems, nor a stroboscopic artefact. The crests and troughs of the travelling wave are truly brought to rest in the laboratory and indeed it is possible to reverse the original direction of propagation, without reflection, by increasing the rotational speed of the motor.

An interesting conceptual problem then arises with regard to the magnetic field of the wave. The particular apparatus described here is not designed in such a way that the magnetic field may be sampled and there can be two schools of thought on whether or not it is also stationary. One argument is that as the charges are not moving in the laboratory there ought to be no magnetic component. The other argument is that as the travelling wave has a magnetic field in phase with the electric field this magnetic field should appear stationary when the electric field is ren-

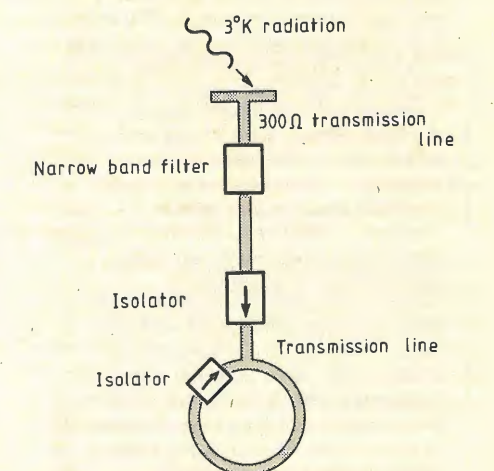

Fig. 2. More practical arrangement for putting the wave into the circular line.

CIRCUIT IDEAS

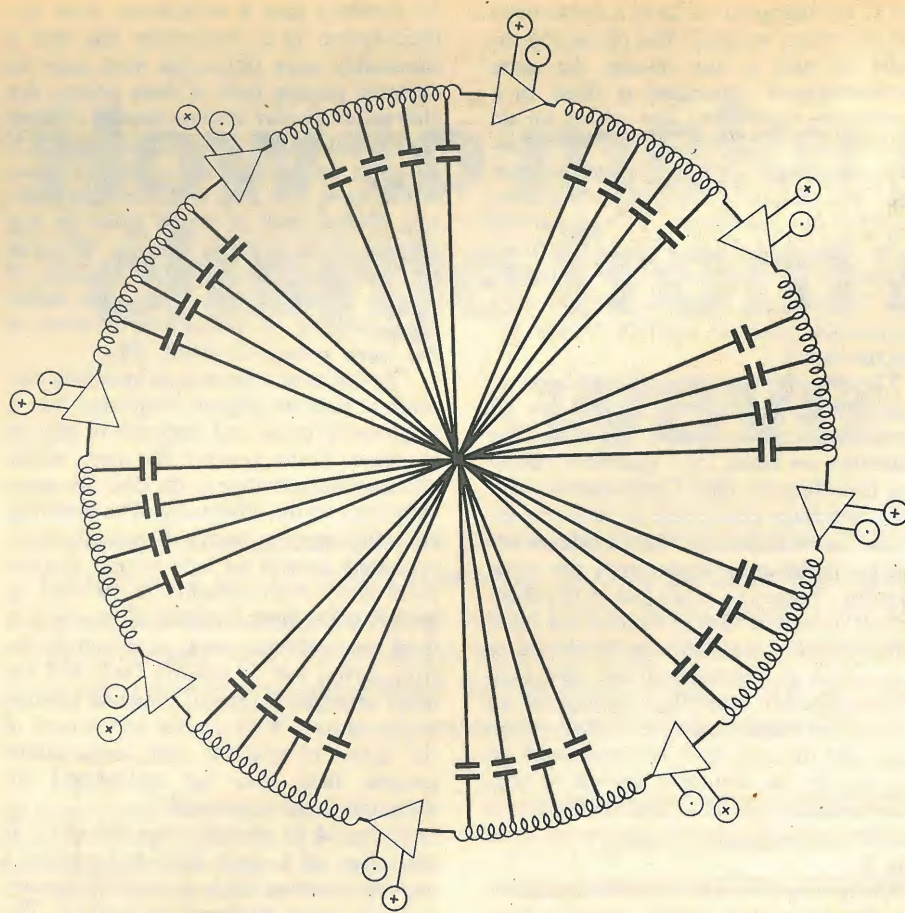

Fig. 3. Artificial delay line whose construction is described in the text in which a wave runs in the clockwise direction. Rotation of the system in an anticlockwise direction at the same angular frequency as that of the wave produces a static field. Red and green light-emitting diodes, connected at the points marked + and -, indicate the stationary wave, as on the cover photograph.

dered stationary. It appears that the first argument is fallacious for it ignores the motion of the system relative to the wave and there is also no known mechanism whereby the Maxwellian property of the wave system should break down even when the velocity, relative to the observer, is reduced to zero.

This demonstration is crude but very enlightening. We have got rid of one of the criminals who were travelling hand-in-hand at the beginning of this article. Nature probably has a much better way of achieving the same thing by so convoluting the electromagnetic field in the unique mechanism of electron-positron pair pro-

Professor Roger C. Jennison, B.Sc., Ph.D., C.Eng., F.IEE, FIP, FRAS, PPIE, FRSA, was born in Grimsby and studied engineering in Hull before volunteering for aircrew in 1942. Demobilized in 1947, he decided to start again and read physics at Manchester University, graduating with an Honours degree in 1950 and a Ph.D. in radio astronomy in 1954. In this period he deduced that the Cygnus A radio 'star' was double, invented 'closure phase' and a number of other techniques and was successively lecturer in radio astronomy, then senior lecturer in radio astronomy, and later in physics. In 1959 he turned his attention to medium-wave radio astronomy and cosmic dust research. He developed the first foil detectors and with experiments on rockets and the Ariel II satellite he showed that there was no danger to space travel from the cosmic dust which had previously been thought to be a severe hazard. In the early 1960s he became interested in problems of gravitation and rotation and was also elected President of the



Institution of Electronics. In 1965 he accepted the chair of physical electronics at Canterbury where he founded the Electronics Laboratories and recently added a chair of radio astronomy to his titles. He has maintained an interest in trying to understand fundamentals and has contributed an alternative explanation of inertia and quantization among his 90 published works.

duction that a perfect system is formed which has all the stable and wonderful properties of an electron and merits the concept of charge which is now fully ingrained in our conception of the properties of matter.

Having formed a static field from a travelling electromagnetic wave I am quite content, contrary to other views expressed in *Wireless World*, that if I hurl it around on a string it will give rise to freely propagating electromagnetic waves at the frequency of rotation, the energy coming from my muscles as I whirl the string. If, however, you ask me what these electromagnetic fields are then I must confess, along with Feynman, that I have not the faintest idea. It is a pity that some of the classical apparatus has disappeared from modern teaching. It is my belief that every budding researcher should be given a gold leaf electroscope to contemplate for a few minutes every day. Ultimately someone may really explain the phenomenon which keeps the leaves apart. **WW**

LITERATURE RECEIVED

Over 40 different types of coaxial cables for data transmission, radio and microwave frequency transmission and communications are listed in a brochure from Greenpar Connectors, PO Box 15, Harlow, Essex, CM20 2ER. **WW401.**

A tutorial manual describes the generation of graphics using Regis (remote graphics instruction set) for use with the VT125 terminal. The VT125 Regis Primer consists of 11 chapters in 130 pages and provides a full description of each command or function with worked examples and illustrations. £6 from Rapid Terminals, Denmark Street, High Wycombe, Bucks HP11 2ER. **WW402**

'Magnetic materials and components' is a folder containing information on the Arnold ranges of Mo-permalloy powder magnetic cores, and other iron powder cores, tape-wound cores, and other magnetic materials. Walmore, who issued the folder as well as stocking other manufacturers' magnetic materials, also manufacture ferrite toroidal cores for use in switching power supplied. Walmore Electronics Ltd, 11 Betterton Street, London WC2H 9BS. **WW403**

The Toolrange catalogue in its latest 1983/84 edition is even bigger than its predecessors, listing tools, tool kits and tool boxes as well as a range of test instruments and other production aids. Anything from tweezers to power drills. Toolrange Ltd, Upton Road, Reading, Berks RG3 1BR. **WW404**

SATN and TK!SATN, two publications from Software Arts, are for users of Visicalc and TK!Solver data processing packages. Available from Software Arts Products Corp, 27 Mica Lane, Wellesley, MA 02181, USA. **WW405**

Photomultiplier tubes (with high efficiency arc rubidium-caesium types), according to literature from Thorn EMI Electron Tubes Ltd, Bury Street, Ruislip, Middlesex HA4 7TA. The new tubes are plug-in replacements for the older ones in the Thorn EMI range. **WW406**

Direct reading cable reflectometer

This circuit measures the length of a cable by comparing the delay of a reflection of a rising edge sent down the cable with a standard time interval.

A 20µs 2V square wave is driven into the cable from 75Ω and a fast dual comparator

NE521 and nand gate give 0 output during the period that the waveform is between ½ and 1½V. During negative half-cycles the comparator is gated off to prevent falling edges on an open circuit triggering it. The resulting waveform is amplified and clipped, filtered to leave only average d.c., and applied to a digital panel meter. Zero cable length gives approximately 1V d.c.;

1000m gives approx. 2V, thus 1mV = 1m = 10ns. Open/short circuit indication is given by latching the output of the comparator with the higher (1½V) threshold just before the falling edge of the drive waveform.

J. Andrew Suter
Thames TV Ltd
London

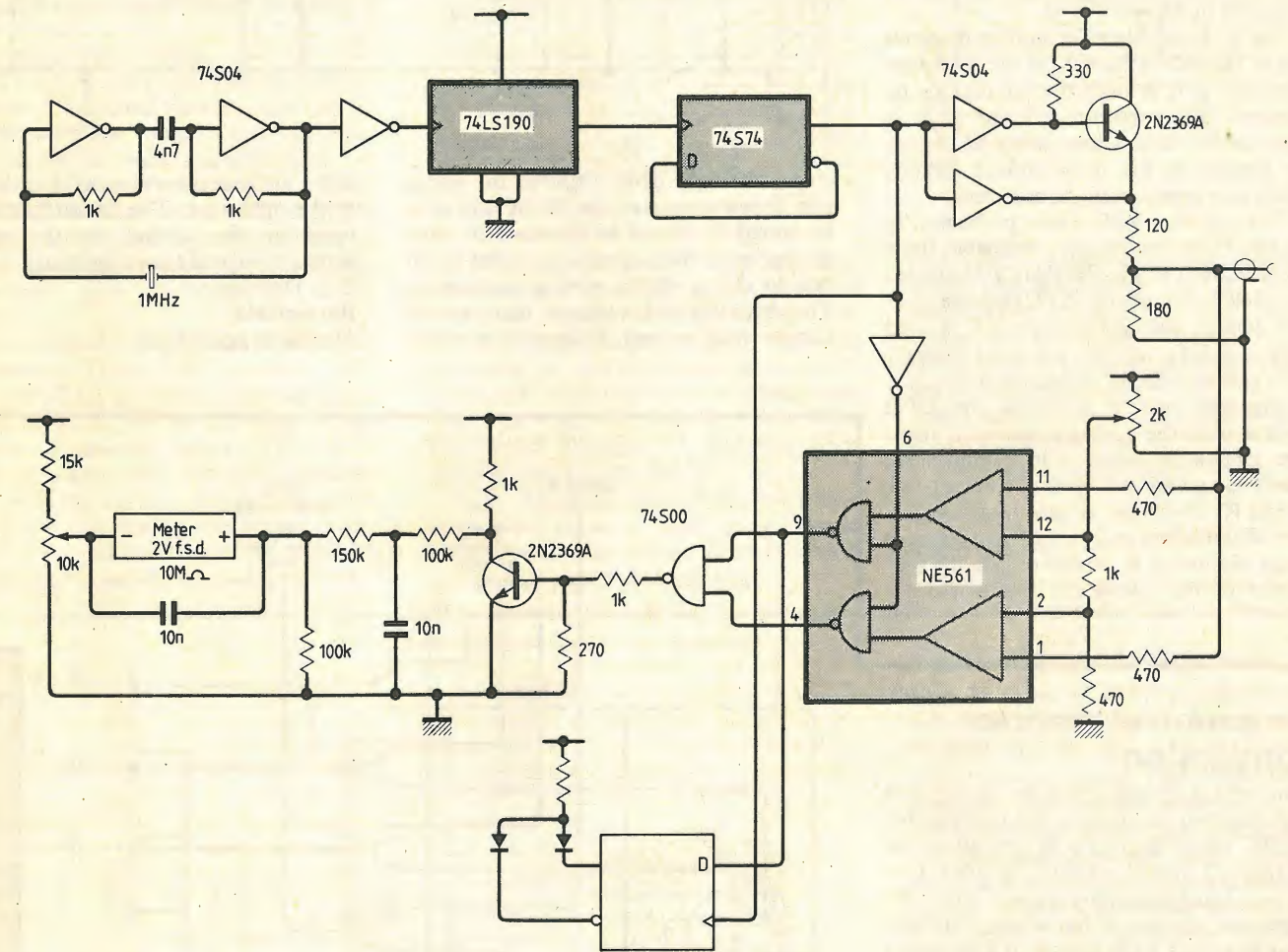

Predictable relay oscillator

A single relay connected to interrupt its own supply simply behaves like a buzzer. And the same is true for a pair of relays connected so that each cuts the supply to the other when energized. So the usual oscillator employed by British Telecom uses three relays, as described by Atkinson (Telephony II, page 304). The relays are arranged in a ring, so that each when energized cuts the supply of its predecessor. Also each coil has a resistor connected in parallel, to delay release. When power is applied to the ring there is a short and unpredictable struggle, followed by regular cyclic oscillation.

A predictable two relay oscillator is shown below. Contact positions are drawn for S open (Except for B₂ - sorry).

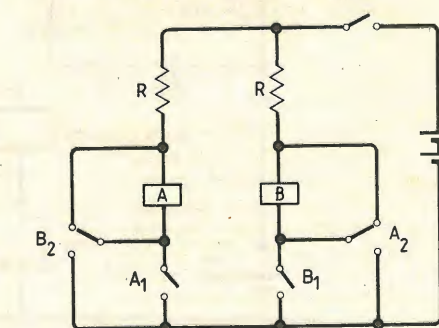

This arrangement cannot act like a buzzer, because of the toggle action. Thus relay A cannot cancel its instruction to relay B at once, but instead its changeover contact must move right across its gap. Output can be taken from a further contact. Frequency is 3-10Hz, depending on obvious factors.

A relay oscillator will usually be started by the contact S when output is required, so start-up is of interest. The version illustrated has entirely predictable start-up, and saves a relay. It has functioned cheerfully for 20 years in a private telephone exchange.
M. McLoughlin
Haberdashers' Aske's School
Elstree

Opto-coupled trigger for electronic ignition

This circuit is designed to improve the triggering performance of capacitor-discharge ignition systems using thyristors as the discharge element. This is accomplished using an opto-thyristor which, while providing an enhanced drive to the discharge s.c.r., requires a reduced drive from the points circuit. This circuit has been tested with both the Marston (Jan 1970) and Cooper (March 1982) circuits described in *Wireless World*.

One of the problems in ignition design is that of the gate sensitivity of the discharge thyristor; if it is high the circuit can be triggered by transients and the s.c.r. is more costly. If it is low, large RC values are needed in the differentiator circuit, which may upset timing at high revs.

This circuit avoids these problems by the use of an opto-s.c.r. obtainable from RS as 308-001 or the GE H11C4/Monsanto MCS2-400. It is a 6-pin d.i.l. package.

A 100mA gate-sensitivity s.c.r. is used with a 2.2kΩ resistor mounted directly from gate to cathode. When the opto-s.c.r. is triggered current flows via the 220Ω resistor until the conventional s.c.r. fires. The opto-s.c.r. then self commutates, effectively giving d.c. gating. Components C₁ and R₃ are chosen to give best suppression of transients over a wide temperature range. Reducing R₃ would reduce the sensitivity of the opto-s.c.r. but would in-

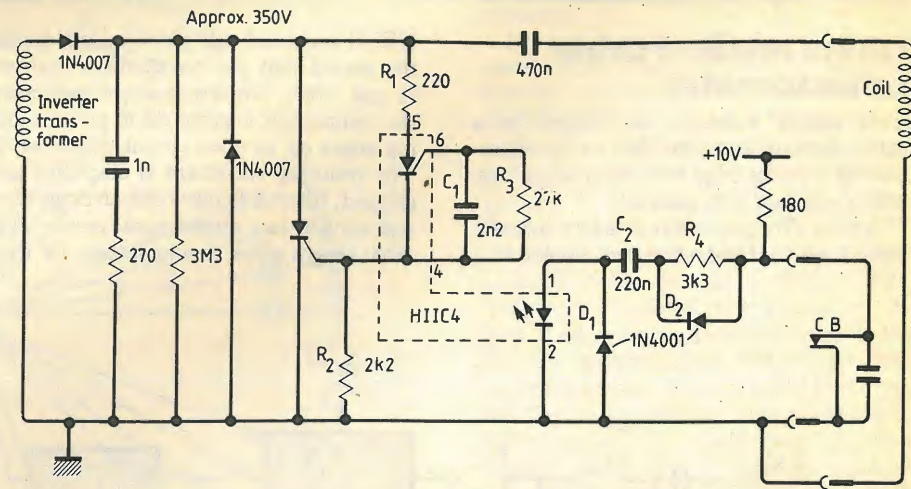

crease the light drive required for operation at low temperatures. If the unit is to be potted C₁ should be increased in value to cope with the increased coupled dV/dt due to the μ_r of the potting compound. The drive circuit is basically that used by Cooper with revised differentiator values

and a diode in inverse parallel to the l.e.d. in the opto-s.c.r. The circuit has been in operation for several months and has shown no sign of false triggering. P. J. Dinning
Burnopfield
Newcastle upon Tyne

Economical monitor conversion

Many recent teletext colour tvs can be used as RGB-input monitors as this interface for a BBC computer and a tv set using the TDA3561 series colour-decoder i.cs shows. Synchronization signals from the computer operate a miniature four-pole relay to switch RGB signals to data inputs of the TDA3561 and route computer sync signals to line and field timebases. The p-n-p transistor forces the TDA3561 data/video control terminal to the data state and might be used to disable the i.f./detector i.c. to prevent video breakthrough. RGB outputs of this computer are not standard video levels and require attenuation; long connecting leads should be avoided since synchronization output is t.t.l.

Teletext decoders are often fed by the composite-video signal sent to the tv timebases and it is worth ensuring that the decoder also receives computer synchronization signals at its video input. With some makes of receiver, switching to teletext mode will remove interlace flicker on the computer display. Check that the receiver chassis is mains isolated before making the modification.

Richard Norwood
London SE25

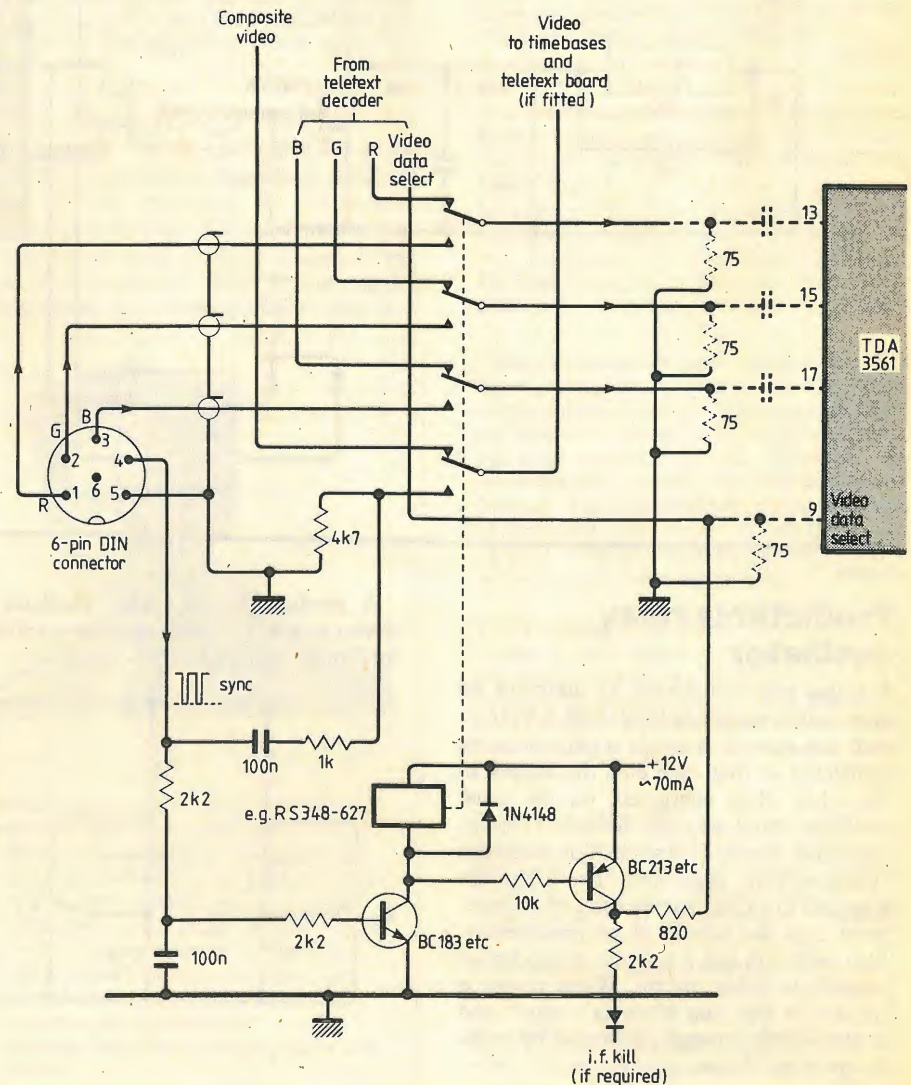

Non-volatile ram module

A non-volatile ram module can be constructed using a low-power static chip and a few additional components. The basic requirement for non-volatility is to maintain the static ram in a standby mode when it is removed from the external circuit or when the external power supply is switched off. The standby mode is achieved by maintaining about 3 to 5 volts on the supply pins of the ram and by holding the chip enable line, CE, within a few millivolts of the positive rail. The low-power static rams, such as the HM6116LP-4, draw only 4μA in a standby mode. Thus small mercury cells may be used as a 'power' supply that will last, theoretically, for years. It is important that the stand by cells do not drain down to the external circuit when the external supply is switched off. It is also important that no voltage exists between any two pins of the non-volatile ram module when unpowered.

The circuit shown achieves all these requirements. Three 1.4V mercury cells (type MP675H, or similar) maintain a potential of about 4V on the chip in the absence of external power. The OA47 diode, in series with the cells, protects them from the external supply. All other pins of the chip (except GND) are maintained at the positive supply rail potential through 47kΩ resistors. To isolate the mod-

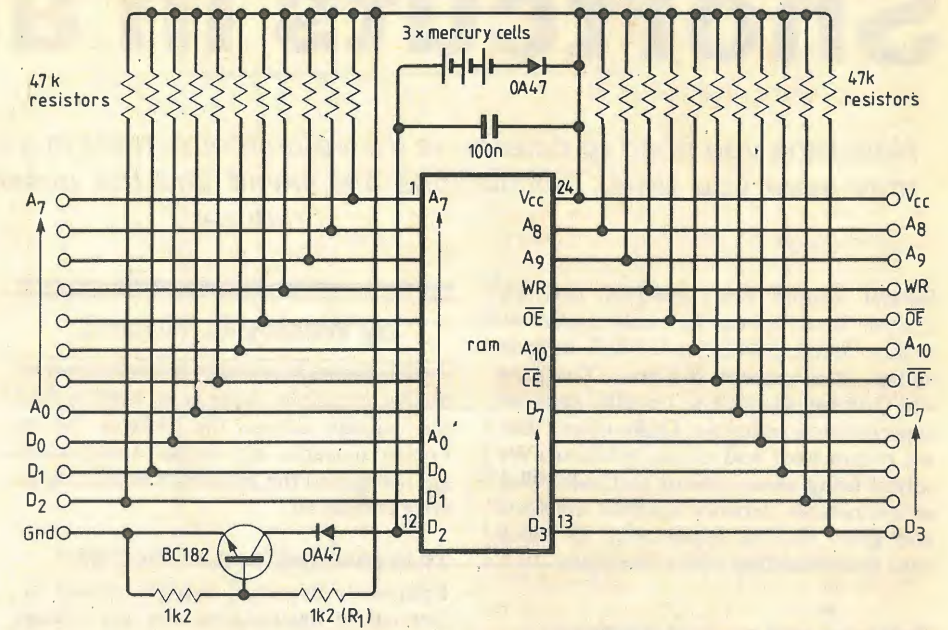

ule from external circuitry when the external supply is switched off, a transistor switch is placed in the GND line. The presence of an external supply turns the transistor 'on' and its absence turns it 'off'. The OA47 diode in series with the transistor prevents the mercury cells from discharging through R1 and the transistor's base-collector diode.

N.B.: The 6116, 2K by 8 bit, low-power static rams come in many guises; some lower power than others. The following information may be of some help:

HM6116P-3 150ns access time, 180mW active, 100μW stand-by
HM6116P-4 200ns access time, 180mW active, 100μW stand-by
HM6116LP-3 150ns access time, 160mW active, 20μW stand-by
HM6116LP-4 200ns access time, 160mW active, 20μW stand-by

These are pin-equivalent to the 2716 eeprom.
A. J. Ewins
North Harrow
Middlesex

Two-signal bargraph

Here is a circuit which enables two signals to be displayed on one driver/display. Suitable drivers are type LM3914, 5, 6 which provide linear, logarithmic or VU response. The simplest arrangement is to use a dot mode display and multiplex the two input signals at high speed. Two leds are thus lit and represent each of the input signals. A stereo VU meter can therefore be configured with one display. The multiplexer uses two sections of a 4066 analogue switch and three inverter gates to form a clock oscillator. The remaining gates of the 4066 can be used to give an alternative display format by switching the display driver between dot and bar modes in synchronism with the input multiplexer. One input signal is then represented as a bar and the other as a dot. Clearest indication is obtained when the dot amplitude exceeds that of the bar. This arrangement was used to provide simultaneous display of peak and r.m.s. values of an audio signal.

Richard Golding
Shrewsbury
Salop

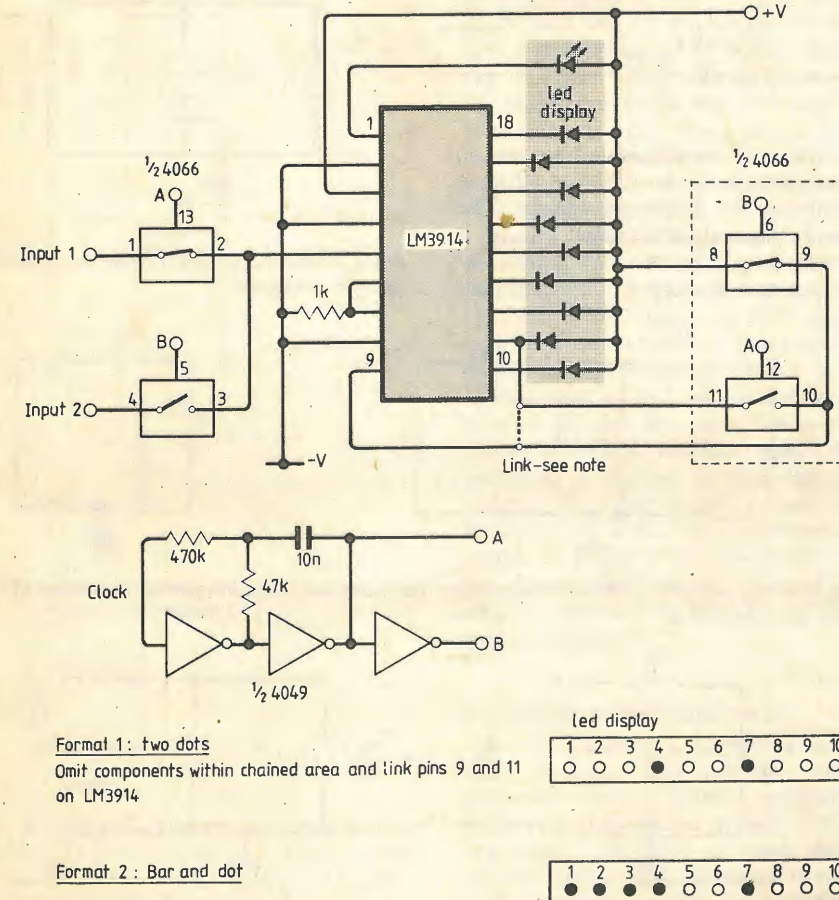

Format 1: two dots
Omit components within chained area and link pins 9 and 11 on LM3914

Format 2: Bar and dot

led display

1 2 3 4 5 6 7 8 9 10

○ ○ ○ ● ○ ○ ○ ○ ○ ○ ○ ○

1 2 3 4 5 6 7 8 9 10

● ○ ○ ○ ○ ○ ○ ○ ○ ○ ○ ○

Shortcuts in analysis

Next time you need to determine the voltage or current in a circuit, one of these shortcuts may save you time. Calculations are saved and the possibility of making an error is reduced.

Several simple but powerful network analysis shortcuts can be easily applied to reduce circuit calculations. These include voltage and current dividers, Thévenin and Norton equivalent circuits and the superposition principle. Quite often, they are overlooked, and circuit problems are solved using more tedious methods. This article reviews network analysis shortcuts and gives you an opportunity to check your understanding with a short quiz.

Voltages and current dividers

Perhaps the simplest shortcut is based on the voltage and current divider effect. The voltage divider effect allows one to calculate the voltage or IR drop across any resistor in a series circuit without first finding the current. For example, the IR drops across R_1 in Fig. 1, is obtained using the expression

$$\frac{V_{IN}R_1}{R_1+R_2+R_3}$$

and equals two volts. In general, the voltage across any series resistor is obtained by multiplying the source or input voltage times the resistor of interest and then dividing by the total series resistance of the circuit.

In many circuit applications, resistors are connected in parallel to form current dividers as shown in Fig. 2. The current divider principle allows one to quickly determine the current in each branch. The formula is analogous to the voltage divider with one important difference: the reciprocal of each resistor is used. For example, in Fig. 2(a), the branch current through R_1 is found using the formula

$$I_1 = \frac{I_T \times \frac{1}{R_1}}{\frac{1}{R_1} + \frac{1}{R_2} + \frac{1}{R_3}}$$

The particular case involving just two parallel branches occurs frequently as shown in Fig. 2(b). Resulting expressions are

$$I_1 = \frac{I_T \times R_2}{R_1 + R_2} \quad \text{and} \quad I_2 = \frac{I_T \times R_1}{R_1 + R_2}$$

For these special cases, each branch current is found by multiplying the opposite branch resistor times the total current and then dividing by the sum of the branch resistors. In Fig. 2(b), $I_1 = 3\text{mA}$, using the above shortcut. When using the current

Wesley Vincent is an electronics engineer in Bringham, Indiana.

by Wesley A. Vincent

divider principle, there is no need to find the voltage across the resistor before branch currents are found. Calculations are saved, and the possibility of making an error is reduced.

Thévenin and Norton theorems

Frequently in circuit analysis, we are interested in determining how the voltage varies at two terminals. In the amplifier circuit, for example, the effect of changing the load resistor may be required. Thévenin's theorem reduces circuits using resistors, capacitors and inductors, along with voltage or current sources to a simple series circuit. To illustrate the theorem, the circuit in Fig. 3 is used as an example. To find the Thévenin voltage, denoted V_{TH} , first open the terminals a-b for the network on the right and then calculate the open circuit voltage without R_L connected. For this circuit, V_{TH} is found using the voltage divider

$$\frac{V_{IN} \times R_3}{R_1 + R_3} \quad \text{or} \quad 3\text{V.}$$

Note that, with the terminals a-b open, no current exists in R_2 , so it has no effect in determining the Thévenin voltage. The Thévenin equivalent resistance, R_{TH} , is determined by calculating the equivalent resistance seen looking into the terminals

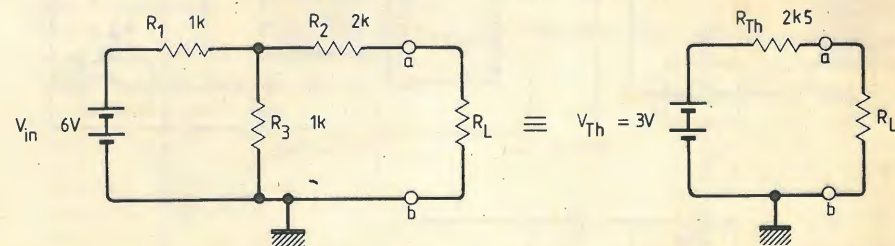

Fig. 3. Making use of the Thévenin theorem; both circuits have the same responses at the output terminals a-b.

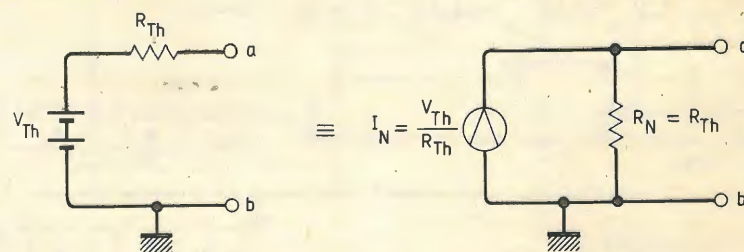

Fig. 4. Finding the Norton circuit from the Thévenin circuit.

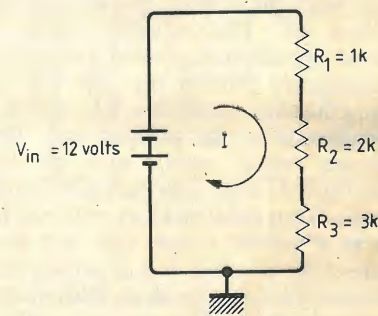

Fig. 1. Voltage divider consists of a voltage source and series resistors. (Positive current notation is used in this article.)

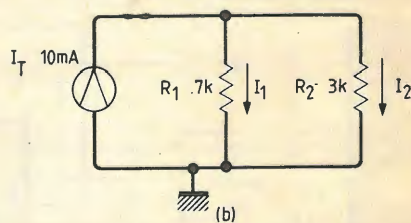
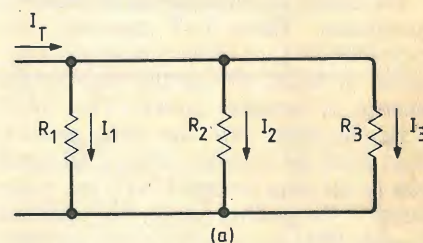

Fig. 2. Current dividers formed with parallel branch resistors.

a-b with the voltage source shorted. For the circuit shown, R_{TH} is the parallel combination of R_1 and R_3 in series with R_2 and equals $2.5\text{k}\Omega$. If current sources are present in a circuit, they are opened (removed) when finding R_{TH} . For the Thévenin equivalent circuit in Fig. 3, it's easy now to calculate the output voltage across the terminals a-b as R_L varies. All that's needed is application of the voltage divider principle as discussed in the last section. More complex circuits are reduced in a similar manner, even though V_{TH} and R_{TH} may be more difficult to determine. But it's easier than the alternative of solving simultaneous loop equations for each different value of R_L .

Another useful circuit theorem, called the Norton theorem, results in the "dual" of the Thévenin circuit and is shown in Fig. 4. The Norton current source, denoted I_N , is the current through the terminals a-b if they were shorted. The equivalent resistance, R_N , is the resistance seen looking into the terminals a-b with any voltage sources shorted or current sources removed from the circuit. The Norton equivalent circuit is particularly useful for determining the current through different load resistors connected to the output terminals.

Superposition principle

One of the most powerful circuit analysis tools is the concept of superposition. This principle applies to circuits containing more than one voltage or current source and allows the total response from a circuit to be found as the sum of each source acting alone.

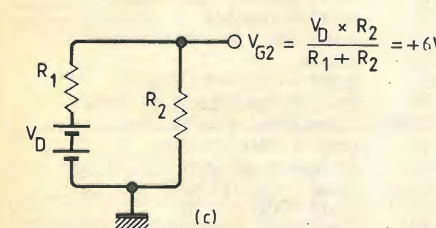
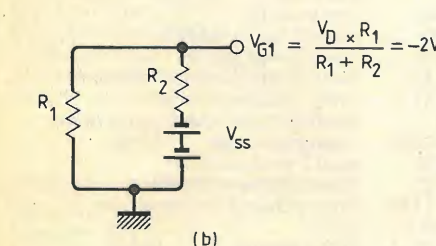
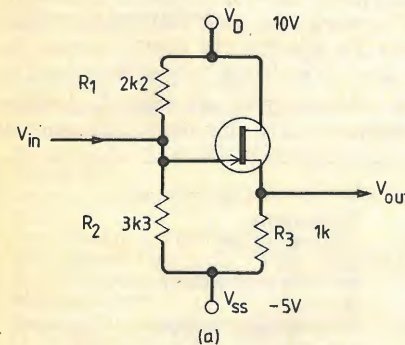

Fig. 5. Using superposition to find the d.c. bias on the gate of a j-fet amplifier. Original circuit (a), determining the effect of V_{SS} (b), and determining the effect of V_D (c).

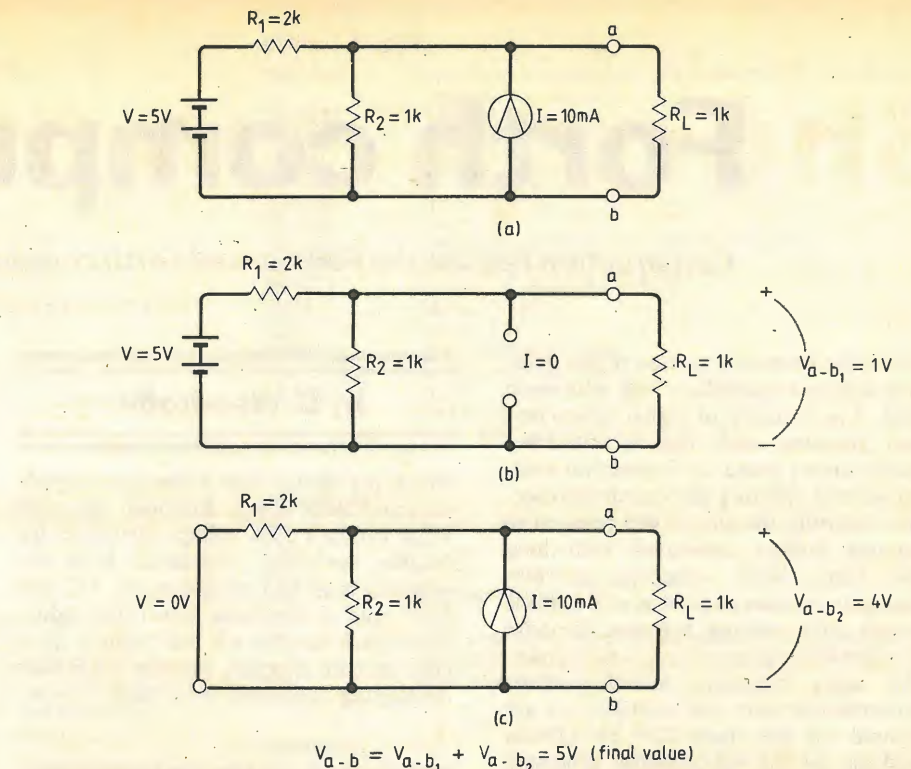

Fig. 6. Using superposition with a current and voltage source. Original circuit (a), circuit with current source open (b), and circuit with voltage source shorted (c).

The usefulness of superposition is demonstrated by finding the d.c. bias on the gate terminal of the j-fet amplifier in Fig. 5(a). (Only leakage current exists through the gate terminal of the j-fet, and its effects will be considered negligible in the calculations.) The effect of each source acting alone is determined from the circuits shown in (b) and (c). The responses from each circuit are added together to give a gate voltage of 4V for the circuit in (a). The gate voltage can be found almost by inspection using this technique. It's important to note that, except for the source under consideration, other voltage sources in the circuit are shorted and current sources are opened.

Figure 6 illustrates the use of superposition, along with voltage and current dividers, when a current source is present. In (b), the current source is first removed, and the output across terminals a-b is found. Here, the voltage divider principle is used with R_1 and the parallel combination of R_2 and R_L . In (c), the voltage source is shorted, and the current divider principle is applied to find the output voltage. Once the output voltage for the circuits in (b) and (c) are determined, their results are added to give the output voltage for the original circuit in (a). For the circuit shown, the voltage across the terminals a-b is 5V.

Capacitors and inductors

All of the circuits in this article contained only resistors. But all the shortcuts discussed apply to circuits containing capacitors and inductors as well. Instead of resistance, reactance is used and impedance replaces combinations of resistors and resistance.

Test yourself

As a test of your understanding of the principles discussed, try your hand at the quiz below. Then turn to page 57 to determine your score.

- Question 1. What is the voltage across R_2 in Fig. 1, using the voltage divider principle?
- Question 2. What is the voltage across R_3 in Fig. 1?
- Question 3. For the circuit shown in Fig. 2(b), how much current exists through R_2 ?
- Question 4. What is the IR drop across R_1 in Fig. 2(b)?
- Question 5. If $R_2 = 1\text{k}$ instead of $2\text{k}\Omega$ in Fig. 3, what is the value of the Thévenin voltage V_{TH} ?
- Question 6. If $R_2 = 1\text{k}$ instead of $2\text{k}\Omega$ in Fig. 3, what is the value of the Thévenin resistance R_{TH} ?
- Question 7. What is the Norton equivalent current, I_N , for the circuit below?

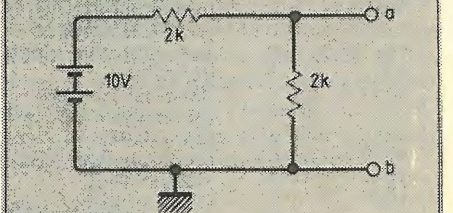

- Question 8. What is the Norton equivalent resistance, R_N , for this same circuit?
- Question 9. Using the superposition principle, what is the IR drop across the $2\text{k}\Omega$ resistor in the circuit below?

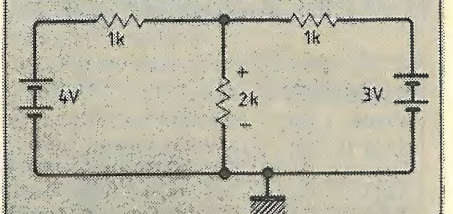

- Question 10. If the polarity of the 4V source is reversed, what is the IR drop across the $2\text{k}\Omega$ resistor?

Forth computer

Construction tips for the 6809-based Forth computer — part four.

by B. Woodroffe

Most of the prototype version of this computer was constructed on one wire-wrap board. The number of signal buses rendered anything other than a multilayer printed circuit board an impractical solution without splitting the circuit into sections. Splitting the circuit was rejected to eliminate buffers associated with long cable runs. Wire wrapping provides connections at least as good as solder joints through cold welding between the wire and edges of the pin.

All main memory, refresh circuit, microprocessor rom and interface i.cs are mounted on the main 229 by 178mm board, as are the video-display processor and memory. The analogue video gate and RS232 driver are built on two 16-pin dip headers. User-port hardware and the disc-drive interface between the floppy-disc controller and the drive are housed on a second wire-wrap board. There are many connections on the board so a powered wrapping tool, a stripping tool and different coloured wires for different functions are useful. Copper-clad board was used for the power supply, which should be constructed before the main processor board.

Dynamic ram takes little static current but substantial pulses, reaching toward

Brian Woodroffe works in research and development at Hewlett Packard.

80mA per device over a few nanoseconds on some clock edges. Although the rams work within a 10% voltage tolerance, for reliable operation substantial local decoupling must be included in the +12 and -5V rails to overcome power-line inductance; each ram has a 0.1µF ceramic capacitor on both supplies. Further 10µF bulk decoupling capacitors were used, one be-

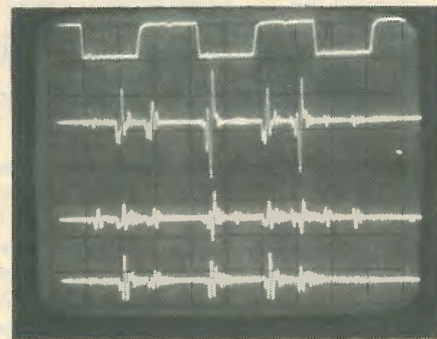

Voltage transients at the 4116 dynamic rams showing from top to bottom the E clock signal and +12V, +5V and -5V supply lines with a 200ns/div timebase.

tween each four devices. Decoupling capacitors for the 5V rail were used throughout the design at the rate of one 100nF component for each six i.cs. As with the RAS/CAS/WE damping resistors, the design seems robust since the ram was initially built and worked without decoupling (see photograph).

This is a large project and all construction errors were found to be the result of either miswiring or plugging in the i.cs wrongly. Dynamic rams I currently use got very hot when I plugged them in back-to-front. Construction should start with a minimum system, i.e. c.p.u., p.i.a., e.proms and a 16K ram. At switch on, the lamp connected to the p.i.a. B-port D₀ line will go on then off. The state of this lamp then monitors the state of i/o data on the line. Ram-select lamps will stay off. V.d.u. hardware is self-contained so an idea of its performance can be seen on a tv screen without involving the main processor as the video i.c. generates its own characters.

Connection of the parity circuit to HALT should only be made after the ram circuits are known to work, i.e. when the system ready message can be displayed consistently. Should the RS232 connection fail to work, the most likely cause, especially if a signal at the a.c.i.a. output can be seen on resetting, is that data lines on pins two and three are crossed. Another problem could be that the RS232 terminal

Main-board components

Resistors		
Value	Qty	Function
10k	8	pull-up, FIRQ, IRQ, NMI, VFOE, RESET, video and RS232 output
10k	2	pull-out parity, video ram, 9-resistor sil packs
100	1	dot-clock
500	1	dot-clock trimmer
20k	1	monostable timing, 5%
400	4	pull-up, led
33	5	damping, RAS, CAS, R/W
75	1	video output
150	1	video output
1k	5	video and RS232 output
2.3k	1	video output
4.7k	1	video output
2k	1	video output
2k	1	video output, trimmer
5.1k	2	RS232 output

Capacitors		
Value	Qty	Function
100µ	2	+5V decoupling, 25V
20µ	2	+12V decoupling and reset, 25V
10µ	8	-5V and +12V decoupling, 25V
100n	57	-5, +5 and +12V decoupling
20p	2	crystal decoupling, 10%
51p	1	dot clock, 5%
20p	1	monostable timing, 5%

Integrated circuits

Ref	Qty	Pins	Type	Comments
11	1	14	LS280	parity checker
12-110	9	16	4116	see note
21	1	28	13242	address multiplexer
22-210	9	16	4116	see note
31,67	2	20	LS245	bi-directional buffer
32-310	9	16	4116	see note
41,44	2	14	LS04	hex inverter
42,47	2	14	LS00	quad 2-input NAND
43,72	2	12	LS02	quad 2-input NOR
45	1	16	LS112	dual JK bistable multivibrator
46,53	2	16	LS161	sync. binary counter
47,48	2	14	LS37	quad 2-input NAND clock driver
51	1	40	M6809A	microprocessor, 1.5MHz
52	1	16	LS139	dual 2-to-4 decoder
53	1	14	LS122	monostable multivibrator
54	1	40	WD1793	floppy-disc drive controller
55	1	40	M6821	p.i.a.
62,63	2	24	I2732	4K by eprom, T _{acc} =450ns
56	1	16	LS175	quad D bistable
66	1	16	LS157	quad 2-to-1 line multiplexer
71	1	24	M6850	a.c.i.a.
73	1	14	LS86	quad 2-input ex-OR gate
74	1	14	LS132	quad 2-input Nand, schmitt
75	1	28	EF96364	video display controller
76	1	20	LS240	octal 3-state inverter
77,78	2	18	2114	1K by 4 static ram
81	1	14	LS00	quad 2-input NAND
83	1	14	LS04	quad 2-input NOR
84	1	16	LS161	sync. binary counter
85	1	24	I2716	2K by 8 eprom, T _{acc} =450ns
86	1	20	LS273	octal D bistable
95	1	16	LS165	8-bit serial shift reg.

See note for other i.c. locations

Other components

2N2222 5 video, RS232 output transistors
 1N4150 2 video, RS232 output diodes
 2N2907 1 RS232 output transistor
 L.e.ds 4 parity checking, high-efficiency red
 6.00MHz crystal
 1.008MHz crystal
 DIP headers for video and RS232 output
 25-pin D-type connector for RS232 output
 Single-pole two-way switch for display-page select
 Three, 16-way insulation-displacement connectors
 Vero 07-0130A wire-wrap board
 Wire-wrap pins (1 packet), wire, tool, un-wrap tool and wire stripper. Wire-wrap sockets:

Pins	Quantity
14	14
16	39
18	4
20	4
24	4
28	2
40	3

Notes

Memory circuit was designed using Mostek MK4116-3 data sheet and most critical timing specification was T_{acc}=135ns (column-address strobe). Positions IC_{57,82,92} are 16-pin dil for plugs a,b and c respectively. Positions IC_{91,93} are also 16-pin dil for RS232 and video signals. Resistors are 10% and capacitors are +80/-20% except where tolerances are given.

Disc interface

Type	Qty	Pins	Comments
LS244	1	20	octal buffer
*38	2	14	standard t.t.l. quad NAND, o.c.
LS123	1	16	dual monostable multivibrator
LS161	1	16	4-bit binary counter
LS163	1	16	4-bit binary counter
LS74	1	14	dual D bistable multivibrator
LS14	1	14	hex inverter, schmitt
LS04	1	14	hex inverter
K1160	1	14	8MHz oscillator (Motorola)
LS138	2	16	3-to-8 line decoder

Other components

Wire-wrap socket, 14 pin (4 off)
 Wire-wrap socket, 16 pin (10 off)
 Wire-wrap socket, 20 pin
 Wire-wrap board 176 by 110mm, e.g. Vero 02-0120H
 34-way insulation-displacement connector
 34-way insulation-displacement cable to drive
 Disc drive, e.g. Teac FD50A (up to 4)
 Drive power connector (AMP1-480424-0)
 Pins for above connector (AMP60617-1, 60619-1, 4 off)
 Decoupling capacitors, 100n (6 off)
 Decoupling capacitor, 100µ
 Input resistors, 333 (4 off)
 Input resistors, 220 (4 off)
 Timing resistors, 30k (2 off)
 Timing capacitor, 2µ 10V
 Timing capacitor, 33µ 10V

Alternative oscillator components

Hex inverter, LS04
 Resistor, 464 (2 off)
 Capacitor, 20p
 Crystal, 8MHz

takes too much current from the -5V supply, an indication being that the rams persistently give parity errors on power up which disappear when the RS232 terminal is disconnected. Forth response OK is preceded by the stack depth.

The problem of driving capacitive loads

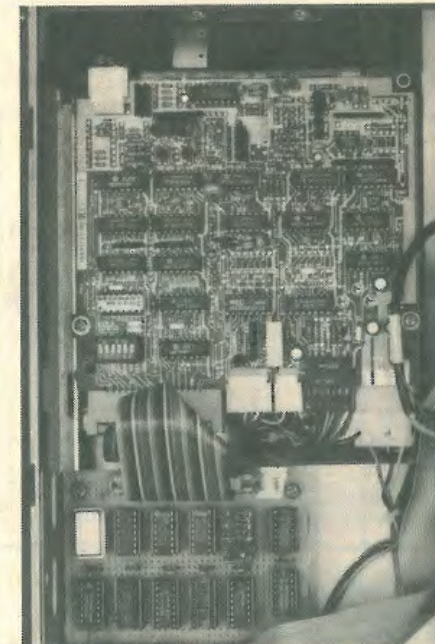

Wire-wrapped disc interface board bottom, and the disc-drive main circuit board.

with l.s.t.t.l. outputs showed up as undershoot in signals passing from the interface board to the controller. Although the prototype worked with the undershoot, it was cured by taking an inverted version of the required signal back to the main board and inverting it

Power supply

MC3405 op-amp/comparator, alternative 158 op-amp and 193 comparator
 12V, 1A regulator
 n-p-n (4 off)
 p-n-p (2 off)
 p-n-p (2 off)
 p-n-p (2 off)
 s.c.r.
 ref. diode, alternative 1N960B 9V zener
 zener, 2.7V
 zener, 3V, alternative 2.7V
 zener, 5.1V
 zener, 12V
 fast recovery diode
 bridge rectifier, 4A
 diode, alternative 30V switching diode, pref. Schottky
 high-efficiency red led, 2.2V drop

Capacitors

1n 10%
 470n (2 off)
 100n (2 off)
 22µ 10V tantalum
 22µ 20V
 1m 12V low equivalent series resistance, e.g. Sprague 672D046 or Dubilier UPC1052
 40V, alternatively 4m

Resistors

0.13 1W
 100 (2 off)
 133 0.25W
 200 0.25W
 680 0.25W (6 off)
 1k
 1.5k
 1.96k
 3.16k (2 off)
 10k (6 off)
 28.7k
 75k
 100k (5 off)
 50k preset pot.

there with a spare l.s.t.t.l. gate. Capacitance of the insulation-displacement connection between the two boards was avoided in this way. Spare connections on the inter-board connector should be grounded and ground should be placed near active signals, e.g. clocks, disc data.

Although for 8K of memory one gets a compiler and operating system and programming and execution unit there is still much to be done. I think that games are one of the best ways to learn about computers for the definition of a problem to be solved is often as difficult as solving the problem. Forth is particularly suited to games programs — the Byte game contest was won by a game written in Forth¹⁰.

Reference

10. A. Saunton-Angus, Cosmic conquest, Byte, Dec. 1982, p.124.

Further reading

C. H. Ting, Systems Guide to Fig-Forth, Mountain View Press.
 Forth Dimensions, Forth Interest Group, PO Box 1105, San Carlos, CA94070 (house magazine for members).

Brian Woodroffe has found a way of speeding up disc operations and data-transfer rates so that faster units such as the Sony Microdrive and 8in drives can be used with the Forth computer. Descriptions will follow.

300baud full-duplex modem

Direct-coupled modem described in the July issue has a separate circuit board for the auto-answer protocol required by CCITT

by Des Richards

This unit provides the interface between the telephone line and the equipment and is suitable for both private wire circuits and the public switched network. It also provides the necessary isolation of dangerous voltages and the transmission of the required signals together with the auto-answer protocol required by British Telecom in accordance with CCITT recommendation V25. The isolation is achieved in two ways: the ringing current is isolated by a discrete-component optocoupler D_2 and Tr_1 and both the a.c. signal isolation and d.c. terminating conditions are achieved by a reed relay and isolating hybrid transformer (which will carry a primary current of up to 120mA d.c. without causing transmission loss to the signal path).

Operation is as follows. The ringing current is detected by D_2 and Tr_1 , and causes C_1 to be charged via Tr_1 and R_2

until the voltage across C_1 reaches the threshold potential of the unijunction Tr_2 . This conducts, discharging C_1 and causing the collector voltage to fall from 12V to about 0.7V. This negative-going transition changes the state of the two monostables IC_{1a} and IC_{1b} . The first has a time constant of approximately 30 seconds and the second a time constant of 2.15 ± 0.35 seconds. The output of IC_1 drives Tr_3 to operate the reed relay RL_1 and answer the incoming call by placing a d.c. loop (T_1 primary) across the line terminals. Simultaneously with the call being answered IC_{1b} triggers and operates RL_2 , which places a 600 Ω termination on the

equipment side of the hold transformer. This gives the silent period of 1.8 to 2.5 seconds as required by V25. When IC_{1b} returns to its stable state the negative-going output triggers IC_{2a} which has a time

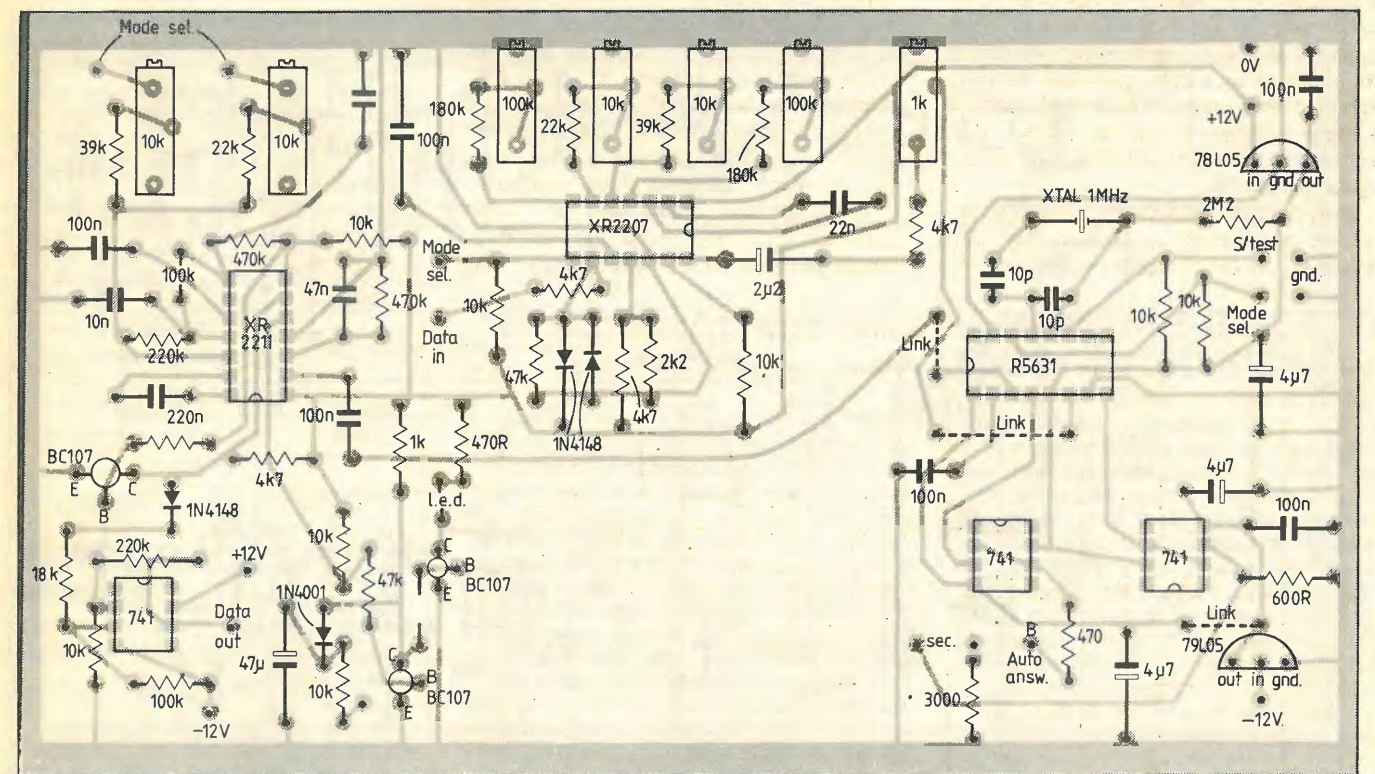
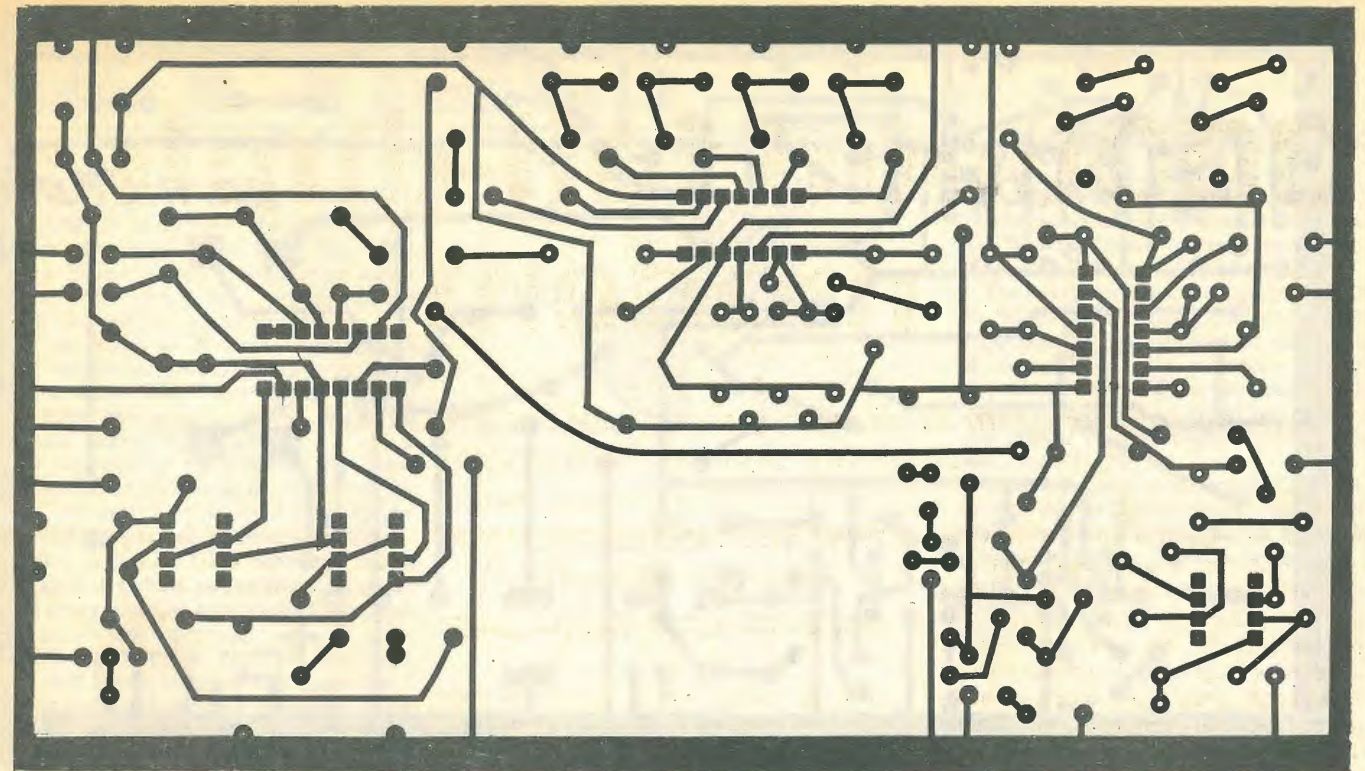
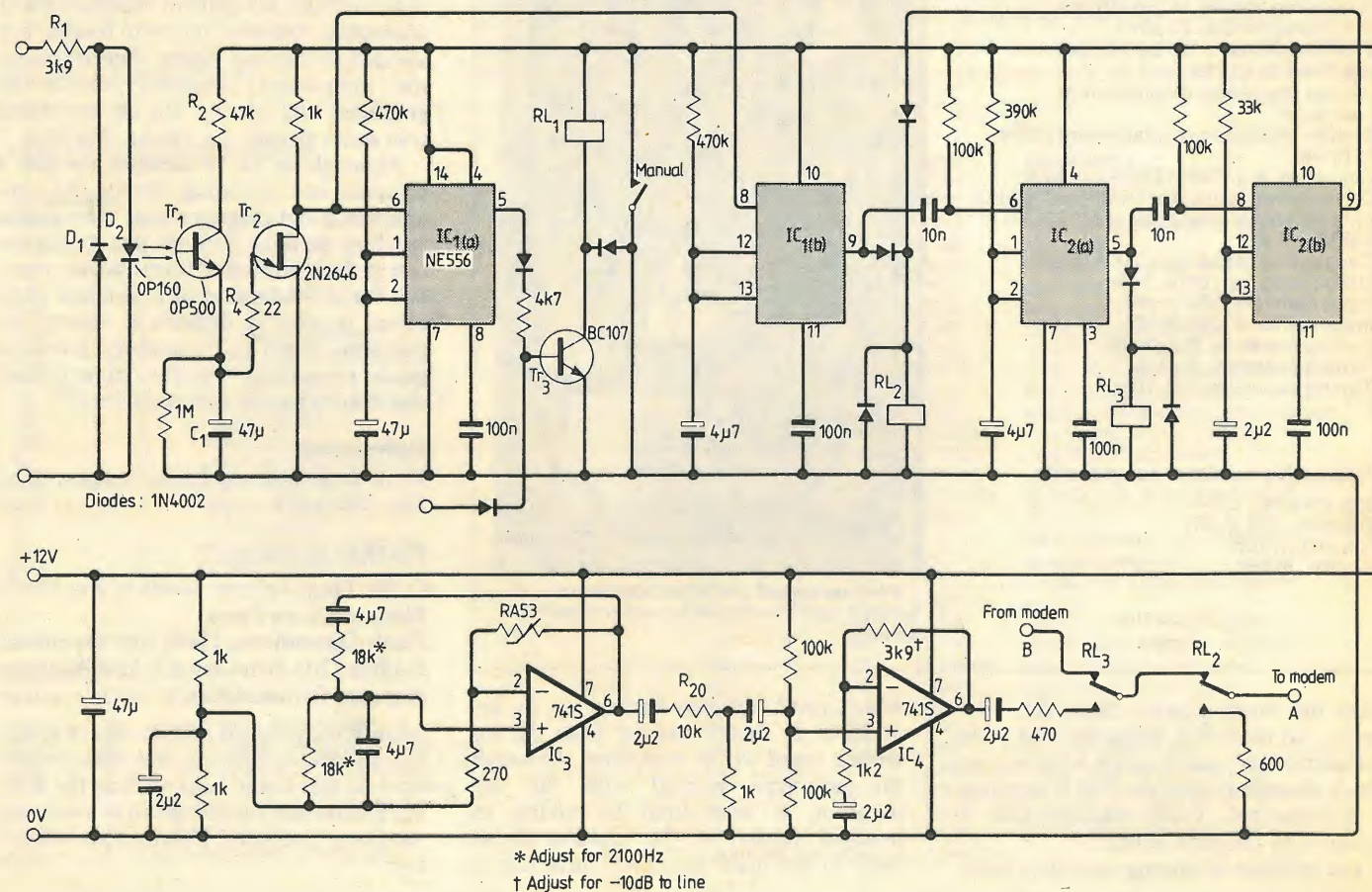
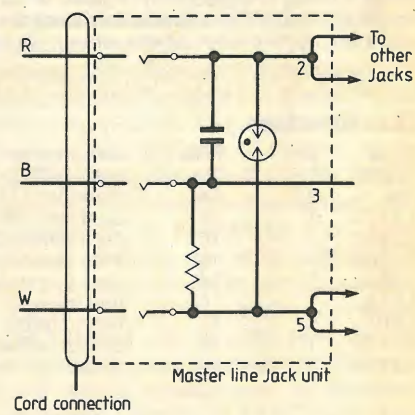

constant of within 3.3 ± 0.7 . This operates RL_3 to switch the secondary of the transformer to the output of the 2100Hz oscillator, to feed tone at -12dB to line. This is another requirement of V25, to disable any echo suppression equipment as used on the telephone trunk and international circuits. When IC_{2a} returns to its stable state it triggers IC_{2b} to switch RL_2 and give another silent period of 75 ± 20 ms. This completes the auto-answering protocol and the secondary of the transformer is fed via RL_2 and RL_3 to the modem board.

The 2100Hz oscillator is a standard

Wein-bridge circuit with a thermistor to stabilize its amplitude. The output level of the oscillator to line should be less than -10dB and is normally set at -12dB.

Power supply

The mains input is fully isolated from the d.c. outputs and protected by a 100mA anti-surge fuse, in the author's circuit. Regulated to give outputs at +12 and -12 volts, there are no adjustments necessary and the voltages should be as specified ± 0.5 volts. The supply is capable of supplying a total of 25VA and can power a number of modems. A straightforward cir-

cuit and board layout are obtainable from the editorial office.

Construction

The complete modem was designed to be housed in two four-inch, 3U high rack modules, one being the power supply and the other containing the auto answer unit and the modem. The power supply p.c.b. mounts on the side of the module and all the components, except mains transformer are mounted on this board.

A modified rear plate has been made to enable the mains input to be made by a separate connector to the d.c. outputs. An

LETTERS

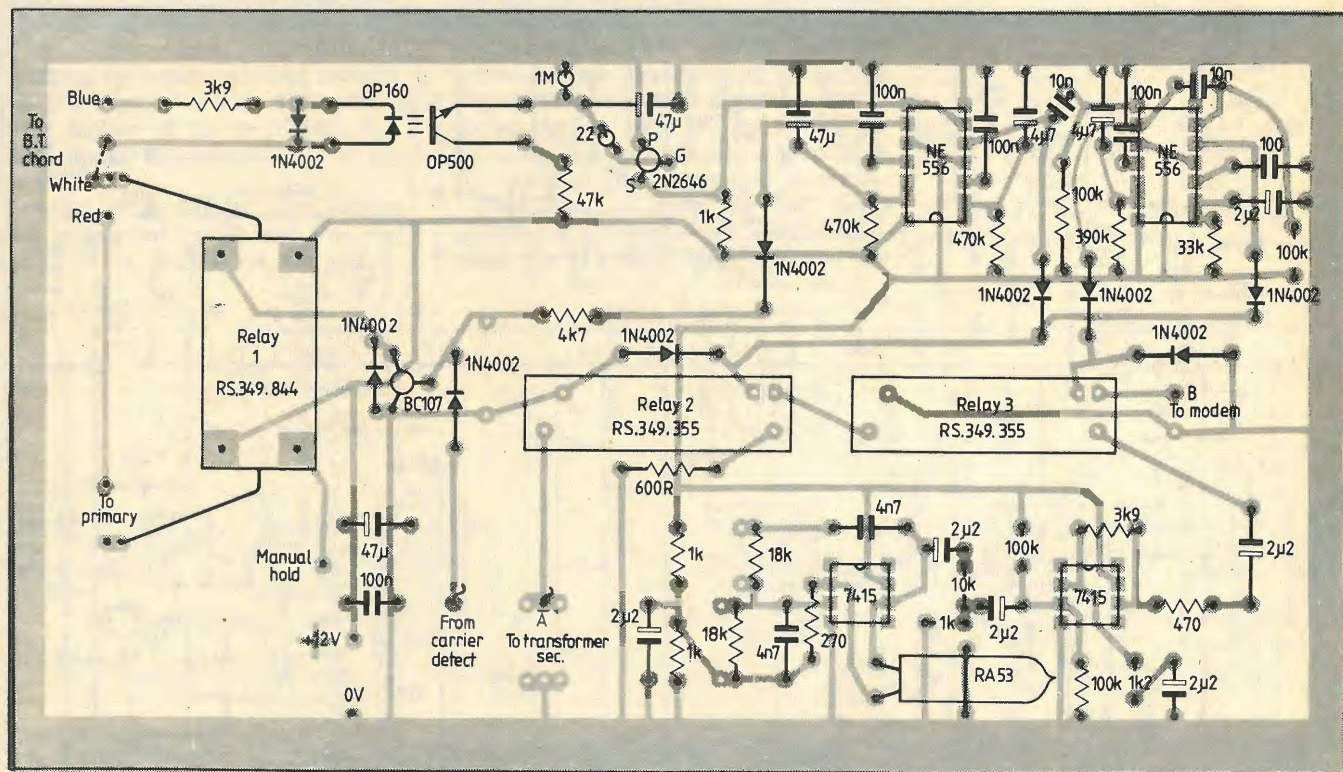
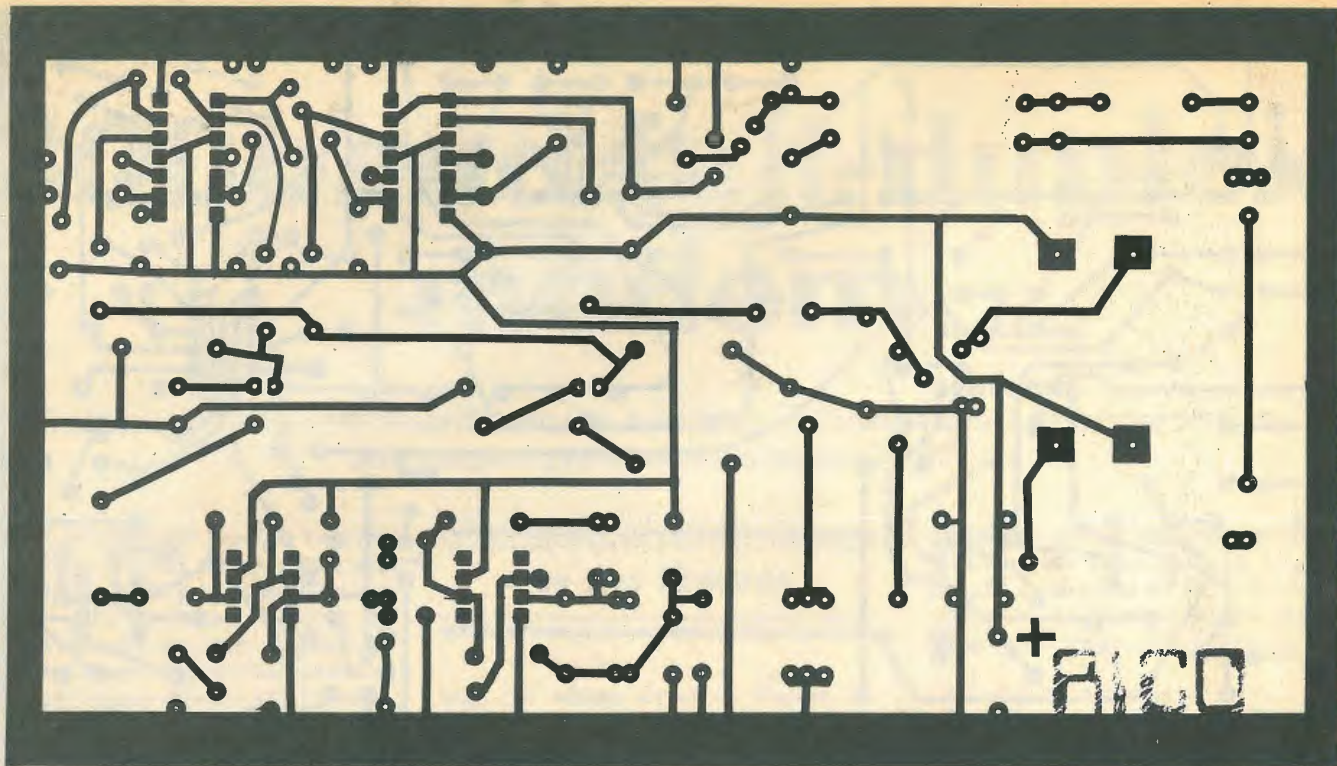

IEC 3-pin connector is used for the mains supply and a 24-way connector for the d.c. supplies. The mains socket and fuseholder should be fully shrouded and all wiring to the board and 24-way connector sleeved at both ends.

The modem unit is built in the second module with two p.c.bs mounted on either side of the unit. The holding transformer is mounted on the base plate between the boards. Connections in and out of the unit are made by a 24-way edge connector at the rear of the module.

Assembly of both boards should not present any problems especially as the

components mount directly on the boards, with the exception of the l.e.ds which are wired to the front panel.

The infra-red diode and phototransistor are glued together with epoxy resin and painted black. This method gives greater pin spacing on the p.c.b. on the ring-detect circuit than would be achieved by using a d.i.l. opto-isolator, and thus meets BT specifications for p.c.b. spacing within protection barriers. Again, all connections to the p.c.b., switch and rear connector should be sleeved to prevent accidental bridging of the protection barriers created by the opto-coupler and the isolating

transformer.

The transformer should be 600 ohm impedance type with 1+1:1 turns ratio.

The Reticon switched-capacitor filter shown in the July circuit can be obtained from Reticon's UK agent EG&G Instruments, at 34 Market Place, Wokingham, Berks RG11 2PP (tel. 0734 788666) for £8.50. A complete kit of parts including transformer and printed circuit boards is being organised by the author - send a stamped and addressed envelope for details to 18 Tulsa Close, Berryhill, Stoke-on-Trent ST2 9PT. WWW

AERIALS AT SEA

It is hard to understand the logic of Mr Benyons' statement (Letters, WW, May, 1983) that it is "unfair" to look at Soviet ships' aerials because these ships are "under military control". I would like to point out that:

● By no means all Soviet bloc ships have "good" aerials. As General Booth said to the Salvation Army band, "why should the devil have all the best tunes?", so why should the "red peril" have all the best aerials?

● The experience of the Falklands war shows that British ships are also under "strict military control". Even Mr Benyon would wish them the best possible radio communications capability.

Could it be that the USSR has better trained engineers than we have, not subject to the dollar veto of penny-pinching shipowners, nor rubber-stamp government supervision?

Mr Benyon correctly perceives that short aerials lack much radiation resistance, but I don't see his 20 foot vaulting pole aerial as being any "great leap forward", for the following reasons.

All existing marine transmitters, at 500 kHz, rely on the aerial to provide the tank circuit capacitance. The helical whip has none.

Only low driving-point impedance will confer any benefit. As well as altering all transmitters, it would be necessary to provide feeders and matching coils, introducing more losses than gains. Marine transmitters, unlike their broadcast counterparts, are free from this extra paraphernalia at present.

ARRL "antenna book" points out that a vertical helical wound aerial of quarter wave electrical equivalence, should be a minimum of 0.05 wavelength long. At 600 metres, that comes to 30 metres, so nothing is gained in the area of the height problem. The same book also relates that "some helical antennas have acted as Tesla coils with high power transmitters and have actually caught fire at the high impedance end!"

Back to the drawing board, Mr Benyon.

John Wiseman
Hawthorn
Victoria, Australia

ELECTROMAGNETIC DOPPLER

In the answer to Mr D. Hall (June letters) I suggest that he studies the following picture.

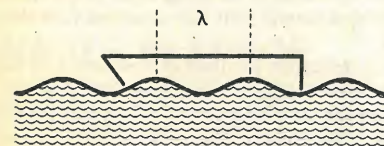

It represents a boat on a lake. Waves are being generated and are propagating across the lake at constant velocity. The point of interest is that there is no way of telling whether the boat is stationary or is moving, the reason being that the wavelength is the only observable parameter and that is unaffected by the velocity of the boat.

The frequency is the number of waves passing the boat in unit time. Clearly the faster the boat moves in the same direction as the waves the less waves will overtake it in unit time. If there are two boats travelling across the lake at different velocities they will experience different frequencies and if we call the velocity of propa-

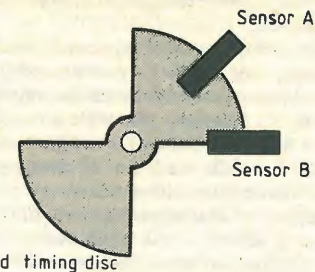

Simplified timing disc

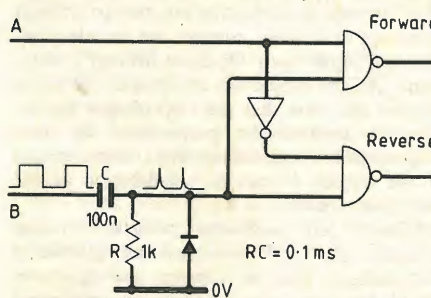
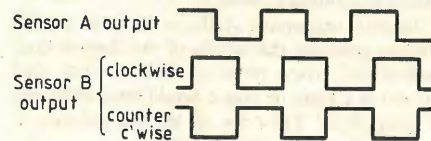

gation C then the formula is:

$$\frac{f_1}{f_2} = \frac{c-v_1}{c-v_2} \quad (1)$$

This is a general formula for any two observers, observing the same wave. If one of the observers is also coincident with the source he may be conventionally described as the source. The wavelength which the source would have produced if it had not been moving is a non-existent parameter, because the source is moving and at no time does that wavelength appear even to the observer at the source. Not only is the propagation velocity constant, but so is the wavelength. The difference in frequency is due purely to the fact that the velocities of the two observers relative to the waves are different. I claim that this model for water also holds for sound waves and therefore cannot be the same for e.m. waves without violating the constant-velocity postulate of relativity.

Mr Hall suggests that the e.m. Doppler equation is only an approximation and should more accurately be as equation 1. This cannot be so because the second order terms such as $v_2(v_2-v_1)/c^2$ cannot be expressed purely in terms of the relative velocity (v_2-v_1) . If accurate measurement did in fact detect such a term it would also have detected other drift. The relativistic Doppler equation is supposed to be accurate even when v is very close to c and the term it contains is $(c-v)/c$.

Mr Hall's point about photons, waves and interference I accept. I'll go away and think about it.

J. Kennaugh
Callington
Cornwall

DIGITAL TAPE CLOCK

The following alternative method for producing the 'forward' and 'reverse' inputs to the counter/display section may be of interest.

The two optical sensors are both mounted on the 'length-of-tape' timing disc, with a quarter-cycle 'phase' difference between them, as simply shown in Fig.1. If these sensors' outputs are fed, suitably buffered, into the circuit of Fig.2, a 90Hz version of the forward and reverse signals results. This can easily be counted down with 2 more 74192s.

Also I am unable to understand the buffering circuitry for the 'length-of-tape' opto-coupler. I would use a circuit like that of Fig.3., with positive feedback for jitter-free operation.

M. S. Farmiloe
Camberwell
London

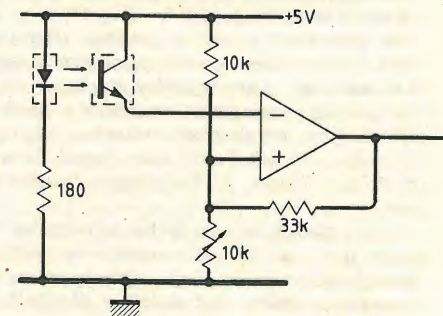

A HERETIC'S GUIDE TO MODERN PHYSICS

Tut, tut, Mr Coleman of July! A photon of visible light has a wavelength?

If it did not bounce back and forth between and amongst its neighbours it would simply keep going in a straight line without a wavelength. But then, a photon, being a packet of energy carried by a bouncing building block doesn't bounce at all, does it? The building blocks merely play "pass the parcel", and the parcel moves linearly if spewed out of a laser, otherwise it is split up providing the so-called square-law effect which is part of an expansion of a spherical surface.

As I said in my letter of July, it takes one particle an impossible amount of work to make a wave. A wave is an integrated effect of a lot of moving particles. It is hoped that there is not some mental mix-up here with spin velocity, which determines the amount of energy within the particle and thus its relativistic mass, and thus in turn the gravitational gradient in the immediate environment of the particle?

I doubt very much indeed whether an individual photon can remove even a conduction electron from a metal, at least not in these parts: its spin velocity would have to be so high that catastrophe was being approached, somewhere near the boundary of the universe perhaps? Of course it takes a wave, an integration of a lot of bouncing building blocks, and therein lies the strength of wave mechanics which sadly explain nothing more than the cause of an effect at the subjective level of apparency, delightfully demonstrative of a shallow and superficial analysis.

Until the specialists of this world come to realise and thus accept that the absolutes are really asymptotes, modern science will remain stuck in its glorious mud. I have in mind absolute zero, absolute resistance, the speed of light, and the basic building block. The asymptotes can not be reached because a multiple lamination of short Planck's constants gets there first.

Space, of course, is purely reactive, there being no friction within chaos: only genuine fully-fledged masses can demonstrate friction at work, in their interactions so demonstrating the decay therefrom. Space, like any other reactive device, is an energy-store out of which mass condenses.

How I wish that the specialists of this world would stop their silly arguments and learn!

James A. MacHarg
Wooler
Northumbria

I continue to read with interest Dr Scott Murray's series on modern physics. However, I must take issue with what I regard as a fallacious argument in the 7th part.

He points out that it is possible, after the event, to determine the position and momentum of an electron "to any accuracy we please". He then goes on to assert that our ability to do this indicates that the electron's behaviour was determinate, and that it must have obeyed the law of causality. Hence, the Copenhagen doctrine is false.

Later, though, he admits that he is unable to prove that the law of causality is obeyed throughout inanimate nature, although there is no evidence against that assertion. Herein lies the flaw, for we can only determine the past properties of the electron if the law of causality has been obeyed. That is, we deduce where the electron was and what it was doing by knowing where it has been subsequently and what interactions it has undergone. If causality did not apply, then we would still be faced with the indeterminacy of instantaneous observation, so an argument that assumes causality cannot be used to refute any doctrine to the contrary.

Almost 30 years ago I was taught by my professor of physics that causality was the underlying assumption in the study of physics. This meant that, given a knowledge of the causal relationships governing inanimate matter, it would be possible to predict the future from a knowledge of the present, which was the goal of the Victorian physicist. The indeterminacy principle, we were told, strikes not at causality but at our knowledge of the present. If that is uncertain, our predictions must change from certainties to probabilities. Perhaps I move in the wrong circles, but I have not met anyone who seriously contested that interpretation. I have to admit that much of my working life has been spent among engineers.

R. T. Lamb
British Telecom
Milton Keynes

Dr Scott-Murray's articles on a heretic's guide to modern physics have clearly shown that the Copenhagen philosophies and mathematical theories of statistical wave mechanics have left scientists without a fundamental theory of matter.

Probably the most glaring error made by the Copenhagen School is their deduction that superfluid helium is a special type of quantum

liquid, to which they have devoted many papers and given many names: Liquid Helium II, Landau's two-fluid liquid, Bose-Einstein Condensate.

The common sense approach of Faraday, Newton, and Galileo, recommended by Dr Scott-Murray, easily deduces that superfluid is a powder. It is a fluid like table salt and pepper but it is not a fluid like vinegar, which is a liquid. Scientific studies of all the properties of superfluid helium show that every experiment demonstrates that superfluid helium is the solid phase of helium in the physical form of a very fine transparent amorphous powder which is only 3°C below its boiling point; hence it is a rapidly subliming powder.

Because university students have to accept without question the beliefs of the Copenhagen statisticians, they have to believe that this powder is a form of magic liquid with antigravity properties. They are all baffled because it doesn't behave like other liquids.

Throughout my career in science I have used the wave concept of light and the particle concept for an electron. I can explain the photoelectric effect without resorting to a photon particle concept and I can explain the behaviour of an electron in an electron microscope without resorting to a wave concept for an electron. Hence I agree with Dr Scott-Murray's statement "All the indications explored in this series support the view that the Copenhagen myths, although undoubtedly propounded by their originators in complete sincerity, constitute one of the biggest hoaxes of self-delusion of the twentieth century".

When I left Cambridge (with a first-class science degree) in 1949 I was a firm believer in the photon, wave mechanics and quantum liquid, but thirty years of scientific experiment and study has shown to me that photons, phonons and rotons are myths and superfluid helium is, as one would expect by common sense, solid helium in the form of a very fine powder. When this powder melts at 2.2K it absorbs latent heat (the λ effect) and becomes normal liquid helium which boils at 4.2K.

P. Holland
Egremont, Cumbria.

Now that Dr Scott Murray's series of articles on physics has ended, I hope that you will continue to have a physics section in *Wireless World*. If so, why not name it, "Frontier Physics". There are no doubt others like myself who buy your journal not for its electronics but solely to enjoy reading those controversial physics articles — and, of course, the Letters section in which wayward physicists express their ideas can certainly stimulate one's own thoughts.

It is a pity that physics has become dogmatic. Some years ago I proved that Special Relativity was mathematically and physically wrong, but I couldn't convince others. However, I did discover that there was a 'closed loop' acting in physics.

The closed loop is an argument. It consists of a main theme, which cannot be disputed, and which begins and ends any discussion. For example, the closed loop of Special Relativity can be used to prove that time dilates as follows:

1. Special Relativity is true (main theme)
2. Its equations show that time dilates.
3. Its equations cannot be wrong.
4. Therefore time must dilate.
5. Special Relativity is true. (main theme).

In a scientific journal recently, the closed loop is used to show that the cost of accepting com-

mon time (Newtonian time) would be too high a price to pay in physics. The closed loop is as follows:

1. Special Relativity is true. (main theme).
2. Inserting common time into Special Relativity's equations gives a daft answer for the speed of light.
3. This daft answer means that either Special Relativity's equations are wrong or that common time is wrong.
4. Special Relativity's equations cannot be wrong.
5. Hence, common time must be wrong.
6. Special Relativity is true. (main theme).

In the past, the closed loop has been used to give a satisfactory answer to the late H. Dingle's challenging question, "Of two uniformly-moving clocks, A and B, which ticks the faster?" The closed loop gives the well-known answer.

1. Special Relativity is true. (main theme).
2. Moving A ticks slower than stationary B.
3. But stationary B can be regarded as moving and moving A can be regarded as stationary (by the principle of relativity).
4. So A ticks slower than B and B slower than A!
5. Either commonsense is wrong or Special Relativity is.
6. Special Relativity cannot be wrong.
7. Therefore commonsense is wrong.
8. Special Relativity is true. (main theme).

It can be seen that the closed loop is an invincible argument. Of course, the above examples seem obviously silly because they are presented in skeletal form. When the closed loop is clothed with advanced maths, though, its use is by no means obvious; you must look carefully for it!

A. H. Winterflood
Muswell Hill
London

DESIGN COMPETITION

Although I applaud your initiative in setting a competition for electronic devices to assist the disabled, I fear that many potentially suitable devices will not be entered. This is because they may originally have been designed for other purposes, where their commercial value is such that publication of their design is precluded. It would be useful if your journal could also act as a clearing house for information on the existence of these devices.

In many cases, I imagine that the designers of these devices would be prepared to spend some of their own time in adapting them to the needs of disabled people, but cannot reveal how they work.

As an example, Hydraulics Research Ltd has collaborated with the Weed Research Organisation on the development of a low-cost "plant sensor". At present the devices exist in two forms:

- (i) is a linear readout instrument which can be used to indicate the relative health of plants, their degrees of maturity, or the proportion of a field of view which contains plants. It can, for example, indicate on an analogue meter the degree of wear on a grass playing field.
- (ii) is a switch which energises a load when it sees a plant. This is intended for incorporation into a "robot" crop sprayer, when the load would be the coil of a solenoid valve in the line to a spraying nozzle.

The designs originate from the need to make

simple measurements of crop cover during a project which was intended to evaluate the protection which leaf canopy provides from soil erosion by heavy rainfall, and version (ii) is a natural extension of the resulting design into a commercial application.

Both versions will shortly be available from Churchill Controls Ltd of Headley Road East, Woodley, Reading.

One of my colleagues has commented that modified versions of these devices might be very useful to blind or partially sighted people. Such applications would be outside our experience, but we would be pleased to discuss them with anyone who could provide a specification for what is needed, or would like to incorporate one of these sensors in a design of their own.

D. K. Fryer
Hydraulics Research
Wallingford
Oxfordshire

I was interested to see that one reader has come up with the idea of informing blind persons the contents of cans and packages without opening them. No further information was given.

I should like to suggest (if this is not the method used) that it would be a simple matter to 'read' the bar codes that are appearing increasingly on modern packaging by means of a light reader: decoding the information and removing extraneous information normally used in stock control; and presenting the edited information to the blind person by means of a voice synthesizer through a private earpiece.

Being completely without technological training I would nevertheless suggest that in this day of the Chip it would not be beyond the realm of possibility to produce a fairly lightweight pack which could be worn like a handbag over the shoulder and weigh about the same.

Once the technique had been perfected there is no reason why bar-code labels could not be used in other circumstances to aid the blind to read. We already see these codes on the edges of supermarket shelves and on packaging. Why not make complete sentences and print books in the same manner. Naturally a monotonous Dalek 'voice' would never replace the enjoyment of silent reading as Braille offers but this would be ideal for official pamphlets for the blind, direction signs and other informatory instructions.

J. Devereaux
Wordsley
West Midlands

WAVES IN SPACE

Ivor Catt (March, 1983) says "the voltage is half of what one would expect". The curious point to me is on what he bases his expectations. If the charged line is regarded as a voltage source of impedance Z_0 (the characteristic impedance) connected to another impedance Z_0 through the switches, as in the accompanying sketch, then the voltage is exactly what one would expect. The finite duration of the pulse stems from the fact that the charged line is an energy storage device (electrostatic field) and not a source of e.m.f. which implies energy conversion. It is worth adding that the impedance technique also enables one to predict occurrences when the Z_0 of the long line is not equal to that of the charged line.

As to the claimed paradox that "electromagnetic energy promptly rushes away from the path suddenly made available", if Mr Catt will

examine Poynting's vector in the charged line after the switches are closed, he will find that the electromagnetic energy moves only into the long line, that is, from left to right.

It is possible to regard the condition of the charged line as the result of interference between two waves travelling in opposite directions, just as one can treat a straight line as the arc of a circle of infinite radius. There are times when they are useful models of reality. The real paradox of the article is the question of where Mr Catt (and, for that matter, *Wireless World*) have been all this time. To my knowledge, the Royal Air Force used this approach to transmission lines as pulse generators in 1959, and I have no doubt that the technique goes back much further in time.

R. T. Lamb
British Telecom
Milton Keynes

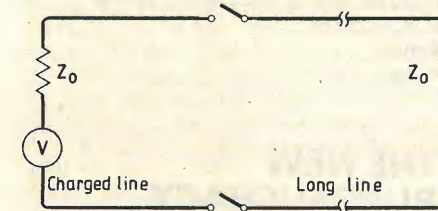

I refer to Mr Catt's article in the March 1983 issue.

In a letter, I could not hope to reproduce the great body of scientific and engineering knowledge that has amply demonstrated the non-relativistic interpretation of Maxwell's Equations or of Einstein's treatment using special relativity. If the theory is so seriously flawed it is surprising that we can design and build antennas and microwave devices. Nevertheless, I cannot let Mr Catt's analysis of the pulse generator go unchallenged, especially as it is so easy to demolish his arguments.

Firstly, if a piece of charged coax. really has equal and opposite waves running in each direction why are they not attenuated by the losses in the line? After all in one second each of his waves would have travelled nearly 2,000 miles in lossy coax.

Secondly, if I connect an antenna to a piece of coax. I can still charge up the line. Why do not these waves of which he speaks radiate into space? Or, at least, the high-frequency components of the pulse to which the antenna will be matched.

The conventional solution to his 'exotic' problem can be found by solving the transmission line equations for a cable under the stated starting conditions (see reference). As this is rather tedious and since Mr Catt seems to prefer hand waving to mathematics I will at least demonstrate where the 2m pulse length comes from.

When the extra length of line is connected to the 1m line, charge starts to move down the new line charging the distributed capacitance of the line through its distributed inductance as it goes. (Maxwell's equations applied to circuits show us that capacitors connected together share their charge). This leaves a void which the 10V (1m) line fills. The void propagates towards the open end of 1m line at the speed of the line. The charge close to the open end of the line will be liberated at a time equivalent to 1m of line and will take 1m to propagate to the other end,

Reference: Brown and Glazier: *Signal Analysis* pp. 345-349.

explaining the 2m length of the pulse.

The pleasing aspect of the above argument is that we do not have to destroy a century of successful electro-magnetic theory to produce it. If Mr Catt has so much more insight into electro-magnetic theory than the rest of us it is surprising that he has not produced any new microwave devices that demonstrate his superior understanding.

Timothy C. Webb
Columbia, MD
USA

I was not too sure whether I should be amused or startled by Ivor Catt's article on "Waves in Space" in which he postulated the existence of electromagnetic energy in a static electric field, when I reminded myself that the date was 1st April. It had never occurred to me, even remotely, that a magnetic field could be directly caused to exist by the presence of an electric field. However, being sympathetic to the idea that all things appear to be possible in this day and age, I allowed my mind to be bent a little further and read on.

The production of a voltage pulse in a transmission line which is half the amplitude and twice the length of that existing statically in piece of coaxial cable, can form the basis of a number of interesting experiments. For example, Mr Catt's travelling pulse can be converted back into a static charge again if his coaxial cable is terminated into an open circuit but with a pair of switches 1 metre from the end as shown in Fig. 1. When the switch at B is closed and the resulting pulse eventually reaches D, it will of course, be reflected (double back on itself); however, if switch C, is opened at the instant the leading edge meets the trailing edge, no great drama ensues but we are left with a 1 metre piece of statically charged coaxial cable as before. It is also interesting to consider what happens if point D is terminated into a short circuit. This time, the pulse will be converted into one of twice the current at zero voltage and the leading and trailing edges will be locked together and oscillate back and forth converting the pulse between a current at zero voltage and a voltage at zero current until this activity decays due to losses.

However, perhaps it would be more interesting to consider what would happen if this final 1 metre of coaxial cable is made superconducting and instead of isolating switches at C, a short circuiting switch is provided as shown in Fig. 2. If the switch at C is closed at the instant the leading and trailing edges meet, electrons at zero voltage, will continue to flow around the 1 metre coaxial circuit as a direct current. It would, perhaps, be better to say that current drifts around, because depending on the construction of the coax., it could take hours for any single electron to work its way around the circuit. It should, of course, be remembered,

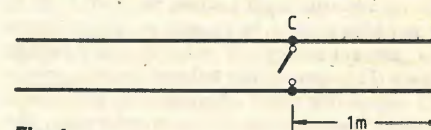

Fig. 1.

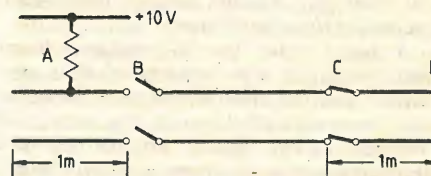

Fig. 2.

that as no voltage is present, the density of the electrons in the closed circuit is the same as that in the remainder of the uncharged transmission line.

Unless someone comes along and throws into doubt that an electric field exists between adjacent electrons and protons it is easy to demonstrate that in the above circuit condition, countless billions of electric fields exist alongside the magnetic field caused by the current, although no measurable voltage exists. Similarly in the case of the purely electrostatic condition, the same large number of magnetic fields exist due to the rotating and spinning electrons. However, I doubt somehow whether this has anything to do with the way the charged section of coaxial cable propagates a pulse whose length is twice that of the charged section. And I must confess, that the prospect of opposing magnetic fields oscillating back and forth along the cable as Mr Catt suggests, appears to be even less likely.

Surely, the answer to his paradox is simply that on closing the switch at B, the electrons that flow out of the negatively charged conductor and those that flow into the positive conductor of the cable not only cause a wave front of current and voltages to be transmitted along the line but also back into the charged section itself. And since the energy has to be shared between both fronts, the voltage will be halved. The discharging current flowing into the charged section will set up a magnetic field, which, on collapsing, will produce an equal pulse of voltage and current to follow on the heels of the pulse which has already departed from the originally charged section.

R. J. Hodges
Bath
Avon

ORBITING ELECTRONS

A puzzling feature of the atomic model which depicts the positively charged nucleus of the atom surrounded by negatively charged particles (or electrons), is that the orbiting electrons do not radiate away energy in the form of electromagnetic waves, and so spiral into the nucleus. This follows from the fact that electrons, when accelerated, generate e.m. waves, by means of which the energy given to the electrons to accelerate them is carried away by the wave, and since the electrons orbiting the atomic nucleus are said to be accelerating towards the nucleus, with the value of the acceleration being v^2/r where v is the velocity of the electron in orbit, and r the radius of the orbit, they should radiate e.m. waves.

I would suggest that the reason they do not, is that it is not sufficient merely for the electron to be accelerating — but energy needs to be given to the electron from outside the system (if we regard the electron in its orbit as a closed system of constant energy), in order to raise its energy level. This system then behaves in such a way as to oppose the input of energy, i.e. to lower its energy level and return to its original state. This it does by means of the e.m. waves travelling at the velocity c , via the lines of force which radiate out from the electron.

A change under "inertial" conditions (i.e. at rest, or moving with uniform velocity), possesses a constant amount of energy, hence, no e.m. waves are emitted from it. The electron will only gain energy when an external impressed force acts on it in which case a human observer located on the electron would be able to detect

this force, and measure it.

If we consider an electron in orbit around the atomic nucleus, and we replace the electrostatic force which keeps it in orbit with a gravitational one of the same strength, then a human observer, since he would be accelerating at the same rate as the electron, would not be able to detect any force acting on the electron, or anywhere in its vicinity, thus, he would conclude that the electron was under inertial conditions, and would not see any e.m. waves emitted, indeed, if he did see such a phenomenon, he would be unable to account for it. In order for such a system to radiate energy in the form of e.m. waves, I would suggest that it would be sufficient for the electron to collide with some other particle e.g. a photon or another electron. Then, a force could be detected by the observer on the electron, and he would conclude that energy had been given to the electron, and e.m. waves would be radiated, whether or not this raised the level of the system as a whole.

P. R. Griffiths,
Retford,
Notts.

THE NEW BUREAUCRACY

I could write at length to refute D. W. Scott's extraordinary assertion in March, 1983 Letters, that "None of us (programmers) likes the von Neumann architecture — we spend our lives trying to circumvent it." Those experienced in the art know this to be false.

I shall limit myself to a simple test of loyalty for Scott and other programmers who might want to bite the (von Neumann) hand that feeds them.

As an accredited MAPCON consultant, the government pays up to £3,000 of my consultancy fees provided my recommendations to my client are that the system he installs contain a von Neumann machine. Please would Scott and other forward-looking programmers write to *Wireless World* to the effect that MAPCON should remove the following paragraph from page 9 of their book entitled "Guidelines for Feasibility Study Grants, March, 1982."

"Note that the use of the word "microelectronics" implies electronic large-scale integrated circuits (LSI) of at least the complexity of microprocessors. Applications which solely use medium and small scale integrated circuits (MSI and SSI) do not fall within the scope of MAPCON."

This quote relates neatly to my first paragraph on page 48, *Wireless World*, December, 1982.

Ivor Catt
St Albans
Hertfordshire

MIXED LOGIC

On page 29 of the July issue, M. B. Butler writes

"A new symbol is introduced to indicate application of a convention: the 'flag' or polarity indicator."

This is not a new symbol. The second most commonly used standard for drawing logic diagrams, the IEEE's ASA Y32.14 — 1962, says on page 8

"4.4.1 A small, open, right triangle at the point where a signal joins a logic symbol

indicates that the line's 1-state (activating) with respect to that logic symbol is the less positive potential (current)."

The competing, and much better, symbol is the small circle. The de facto standard for logic diagrams, US MIL-STD-806B, 26 Feb. 1962, used in 80% of logic diagrams today, says on page 4

"5.3.1 A small circle at the input to any element . . . indicates that the relatively low (L) input signal activates the function. Conversely, the absence of a small circle indicates that the relatively high (H) input signal activates the function."

"5.3.2 A small circle at the symbol output indicates that the output terminal of the activated function is relatively low (L). This small circle shall never be drawn by itself on a diagram."

On page 32, Butler writes

" . . . an oblique 'slash' is placed across any line over which a logical not operation has occurred."

Butler should withdraw this proposal, because it contradicts MIL-STD-806B, page 8, and elsewhere, which defines the oblique slash as indicating multiple lines. This has gained a degree of acceptance in the industry.

The main thrust of Butler's article is to introduce the good philosophical approach outlined in Tony Cassera's article, *WW* November, 1980. It is a pity that neither writer gave credit to S. U.S. MIL-STD-806B for originating it.

My approach to this important and neglected subject is contained in the chapter "Choice of type of logic symbols" in my book *Digital Electronic Design Vol. 2*, pub. C.A.M. Publishing, 1979.

(Perhaps I should repeat that in my opinion U.S. MIL-STD-806B is the best, and that I am willing to supply copies at cost.)

Ivor Catt
St. Albans
Hertfordshire

WOODPECKER

In June 1983 issue of *WW*, Pat Hawker described the "woodpecker" as following "the m.u.f. up and down the h.f. band". Rather than the m.u.f., I would have thought that it follows, more precisely, the optimum traffic frequency.

No doubt I will be corrected if I am wrong.

P. Thompson
Southport
Lancashire

ORGAN INTERFACE

We have been asked to point out that a recording system for pipe organs with electric actions, similar in principle to that described in these articles, has been marketed by Christie Music Transmission Systems Limited, Colchester, since 1979. This originally used a 32Kbyte ram and tape back-up but is now available with 64K memory and disc back-up, giving uninterrupted solid-state recording or playback for about 20 minutes (depending upon the complexity of the music).

A full length item can be saved or loaded from disc in 3 seconds, and a short item using less than 9Kbytes, requiring only one track of the disc, is dealt with in half a second. Provision is made for listing items to give a recital of several hours duration.

Developments in Teletext (IBA Technical Review No. 20): Independent Broadcasting Authority, Crawley Court, Winchester, Hampshire SO21 2QA. Teletext users who have noticed the mysterious pages of apparent rubbish lurking here and there in the Ceefax and Oracle services will be aware that development of the UK Teletext system still continues. This collection of articles describes some of the advanced techniques now in use and some that are still to come. Subjects covered include the preparation of subtitles for deaf viewers; alpha-geometric coding methods for transmitting high-definition graphics; and techniques for redefining the character set to give alternative alphabets.

Guide to amateur radio: 19th edition, by Pat Hawker G3VA. 154 pages. Radio Society of Great Britain, Alma House, Cranborne Road, Potters Bar, Hertfordshire EN6 3JW. Price £2.75, by post £3.44, paperback. This new edition has been expanded to include some of the latest developments in the world of amateur radio, rules and regulations as well as techniques and equipment. An excellent guide for the newcomer.

VHF/UHF Manual: fourth edition, edited by G. R. Jessop, G6JP. Radio Society of Great Britain. 528 pages. Price £8.50, by post £10.31 worldwide, hard backs. This handbook provides practical information and a full range of constructional designs for amateur bands from 30MHz to the microwave region. The new edition has been revised extensively — notably the chapters on propagation and space communications, which should be of interest even to black-box operators.

Teleprinter Handbook: second edition, edited by A. G. Hobbs, E. W. Yeomanson and A. C. Gee. Radio Society of Great Britain. 368 pages. Price £12, by post £13.84, hardback. Conversing by teleprinter might be thought a rather unso-called method of communicating, but it has its enthusiasts. What is surprising about this book in view of the advanced techniques being used in other areas of amateur radio is that it confines itself almost exclusively to the care and operation of electromechanical equipment. It might be supposed that the newcomer to data communications would want to make use of his home computer. But apart from a nine-page chapter describing the construction (using standard t.t.l.) of a v.d.u. for radio-teleprinter use, there is nothing about AMTOR or packet-switching or indeed about computers or computer techniques at all.

Nothing Local about it: London's Local Radio by Local Radio Workshop. 213 pages. Marion Boyars Publishers and Comedia, £3.95 paper cover.

BBC Radiophonic Workshop by Desmond Briscoe & Roy Curtis-Bramwell. 175 pages, BBC £7.75 paper cover.

Introduction to Video by D. K. Matthewson, 175 pages. Bernard Babani £1.95 paper cover. **Tomorrow's Television Today** by Michael J. Stone 118 pages. M. Stone £9.85+65p p&p paper cover.

Television Engineers Pocket Book by Malcolm Burrell & S. 314 pages. Newnes £7.95 paper cover.

Tower's International Digital IC Selector by T. D. Towers. 246 pages. Foulsham £9.95 paper cover.

Interface Projects for the Apple II by Richard C. Hallgren. 170 pages. Prentice Hall International £10.35 paper cover.

Radio Antennas by Stephen Gibson. 165 pages. Prentice Hall International £11.85 paper cover

Medical Effects of Nuclear War by British Medical Association. 188 pages. Wiley £4.50, \$8.95.

Digital PLL Frequency Synthesizers (Theory and Design) by Ulrich L. Rohde. 494 pages. Prentice Hall International £44.95 hard cover.

Local Telecommunications by J.M. Griffiths. 265 pages. Peter Peregrinus £19.

Broadcasting and Society 1918-1939 by Mark Pegg. 293 pages. Croom Helm Ltd £14.95 hard cover.

Bond Graphs for Modelling Engineering Systems by Alan Blundell. 151 pages. Wiley £16.50 hard cover.

Transistor Circuit Techniques by G. J. Ritchie. 168 pages. £10.95 hard cover.

RF Circuit Design by Chris Bowick. 176 pages. Prentice Hall International £17.20 paper cover.

Microchips with Everything by Paul Sieghart. 150 pages. Comedia £3.50 paper cover.

CBasic Users Guide by Adam Osbourne, Gordon Eubanks, Martin McNiff, 212 pages. McGraw-Hill £11.95 paper back.

Confidential Frequency List by Oliver P. Ferrell. 224 pages. Gilfer Associates Inc (PO Box 239, 52 Park Avenue, Park Ridge, NJ07656, USA) \$14 paper cover.

The World Wired Up by Brian Murphy. 154 pages. Comedia £3.50 paper cover.

What's this Channel Four? by Simon Blanchard and David Morley. 186 pages. Comedia £3.50 paper cover.

Annual Report and Handbook 1983 by BBC. 240 pages. BBC £4.50 paper cover.

Television & Radio 1983 by IBA. 224 pages. Independent Broadcasting Authority £3.50 paper cover.

Handbook of Antenna Design by A. W. Rudge, K. Milne, A. D. Olver, P. Knight. 945 pages. Peter Peregrinus hard cover.

Power of Speech (History of STC) by Peter Young. 221 pages. George Allen & Unwin £9.95.

Fiction Stranger than Truth by N. Rudakov. 175 pages. N. Rudakov (PO Box 723, Geelong, Vic 3220, Australia) \$10 paper cover.

Popular Circuits

Electronics Projects

Digital Circuits

Communication Circuits

and Special Circuits (Ready Reference series) by J. Markus. 161-216 pages. McGraw-Hill £9.50 each paper covers.

Electronics: A Course Book for Students by G. H. Olsen. 425 pages. Newnes £17.50 hard cover.

Practical Electronic Building Blocks — 2 by R. A. Penfold. 94 pages. Babani £1.95 paper cover.

Computer Programs for Electronic Analysis & Design by Dimitri S. Bugnolo. 261 pages. Prentice Hall £15.25 paper cover.

Microcomputer Experimentation with the Synertex SYM-1 by Lance A. Leventhal. 500 pages. Prentice Hall £19.75 paper cover. **Basic & Pascal in Parallel** by S. J. Wainwright. 60 pages. Babani £1.50 paper cover.

ZX Spectrum User's Handbook by R. J. Simpson & T. J. Terrell. 199 pages. Newnes £6.95 paper cover.

STD Bus Interfacing by Christopher A. Titus, Johnathan A. Titus & David G. Larsen. 286 pages. Prentice Hall £11.15 paper cover.

Interfacing to Microprocessor & Microcomputers by Owen Bishop. 147 pages. Newnes, £4.95 paper cover.

ZX8000 Handbook by Martin L. Moore. 390 pages. Prentice Hall £11.95 paper cover.

Basic Handbook second edition, by David A. Lien. 480 pages. CompuSoft \$19.95 paper cover.

Assembly Language by Randy Hyde. Prentice Hall £16.95 paper cover.

Introduction to Electronic Speech Synthesis by Neil Sclater. 134 pages. Prentice Hall £7.60 paper cover.

Electronically Speaking: Computer Speech Generation by John P. Cater. 230 pages. Prentice Hall £12.70 paper cover.

Z-80 Microprocessor Advanced Interfacing with Applications in Data Communications by J. C. Nichols, E. A. Nichols & K. R. Musson. 347 pages. Prentice Hall £16.95 paper cover.

Microprocessors and Microelectronics by Ian Williamson. 171 pages. Cambridge Learning £6.50 paper cover.

6502 Assembly Language Subroutines, by Lance A. Leventhal & Winthrop Saville. 550 pages. McGraw-Hill. £10.50 paper cover.

Interface Projects for the TRS-80 by Richard C. Hallgren. 152 pages. Prentice Hall. £11 paper cover.

Practical Interfacing Techniques for Microprocessor Systems by James W. Coffron & William E. Long, 401 pages. Prentice Hall £25.15 hard cover.

TRS-80 Model III Assembly Language by Hubert S. Howe 344 pages. Prentice Hall £14.40 paper cover.

Radiation safety of laser products, BS4803 parts 1-3. British Standards Institution. 13 + 16 + 30 pages. Members £33 paper cover.

European Electronic Component Distributor Directory by Mackintosh Consultants. 464 pages. Benn Electronics Publications £37.50 paper cover.

New Technology and Industrial Change by Ian Benson and John Lloyd. Kogan Page £4.95 paper cover.

Newton's Error by A. H. Winterflood. 72 pages. From H. K. Lewis & co, 136 Gower Street, London WC1E 66S £3 paper cover.

Transient Analysis Aided by Network Theorems by Harry E. Stockman. 176 pages. Sercolab (PO Box 78, Arlington, Mass. 02174, USA) \$13.30 (abroad + 10%) soft cover.

Telegraphy on Stamps by W. C. L. Gorton. 16 pages. Picton (Citadel Works, Bath Road, Chippenham, Wilts) 95pence paper cover.

Art of Programming the I6K ZX81 by M. James & S. M. Gee. 125 pages. Babani £2.50 paper cover.

Computer-Assisted Home Energy Management by Paul E. Field. 182 pages. Sams \$15.95 paper cover.

Learning IBM Basic by David A. Lien. 425 pages. CompuSoft \$19.95 paper cover.

Art of Programming the ZX Spectrum by M. James. 138 pages. Babani £2.50 paper cover.

Literature Received this month appears on pages 38 & 73.

```

0217 LDA#00      A9 00
0219 STAZ 2F     85 2F
021B TAX         AA
021C LDA,X 0300 B0 00 03
021F STAZ 30     85 30
0221 STAZ 2E     85 2E
0223 TXA        8A
0224 TAY        A8
0225 JSR (NVT)  20 00 02
0228 LDAZ 2F     A5 2F
022A STAZ 32     85 32
022C TYA        98
022D TAX        AA
022E INX        E8
022F LDA,X 0300 B0 00 03
0232 STAZ 31     85 31
0234 STAZ 2E     85 2E
0236 TXA        8A
0237 TAY        A8
0238 JSR (NVT)  20 00 02

```

```

023B LDAZ 2F     A5 2F
023D STAZ 33     85 33
023F TYA        98
0240 TAX        AA
0241 INX        E8
0242 CPX*21     E0 21
0244 BEQ 1A     F0 1A
0246 LDAZ 32     A5 32
0248 CMPZ 33     C5 33
024A BCC 07     90 07
024C LDAZ 30     A5 30
024E STAZ 34     85 34
0250 JMP 02 2F  4C 2F 02
0253 LDAZ 31     A5 31

```

Flowchart for Mode for both the 6502 and Z80 processors. It should be possible to compile a program for any other processor from comparing the charts.

```

0255 STAZ 34     85 34
0257 STAZ 30     85 30
0259 LDAZ 33     A5 33
025B STAZ 32     85 32
025D JMP 02 2F  4C 2F 02
0260 RTS         60

```

Appendix

Noise is of course, by definition, random. The probability that a noise will occur during a range measurement can be calculated. Supposing we have a number n which can take the value of 1 or 0 depending on whether noise is present. Then if the duration of a noise pulse is d_m separated by a period t_m then

$$d_m = \frac{1}{n} \sum_{j=1}^n d_j \text{ and } t_m = \frac{1}{n} \sum_{i=1}^n t_i$$

FLOWCHART FOR Z80 MODE

FLOWCHART FOR MODE PROCEDURE-6502

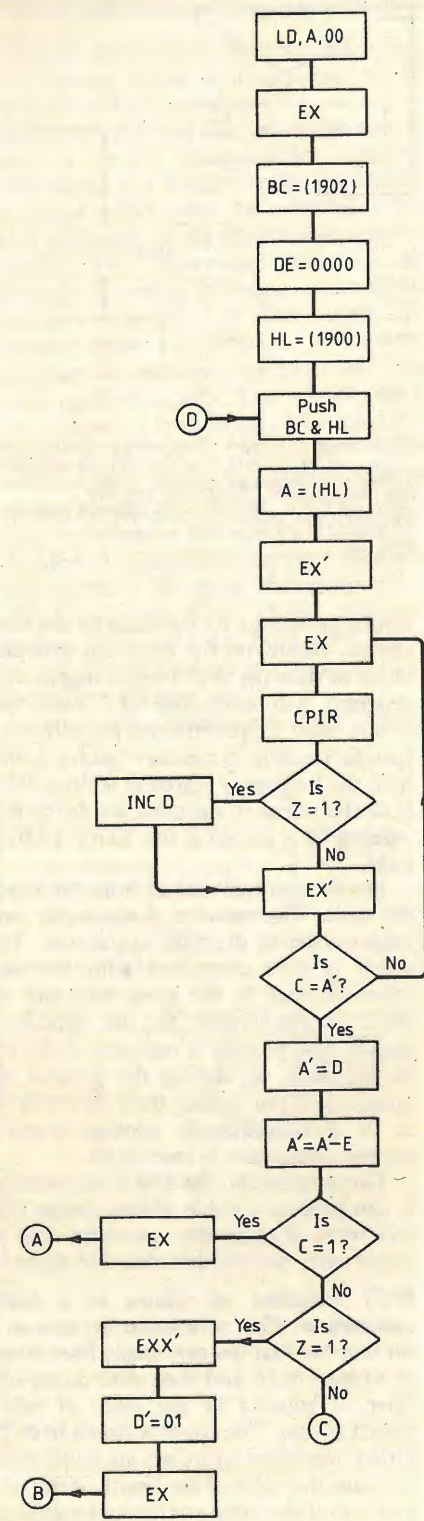
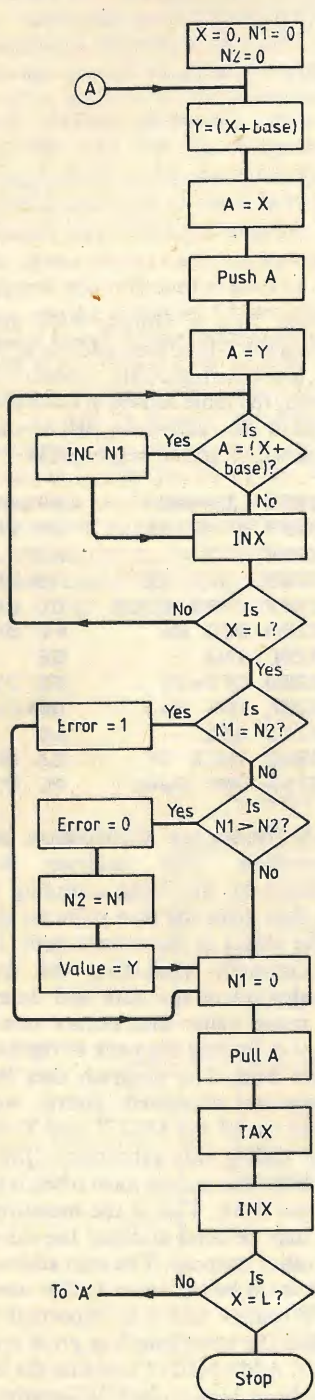

Assembler and machine code program for Mode with the 6502.

```

0200 CL D       08
0201 LDA #00    A9 00
0203 TAX        AA
0204 STAZ 21    85 21
0206 STAZ 22    85 22
0208 LDY,X 0300 B0 00 03
020B TXA        8A
020C PSH A     48
020D TYA        98
020E CMP,X 0300 DD 00 03
0211 BNE 02     D0 02
0213 INCZ 21    E6 21
0215 INX        E8
0216 CPX Z23    E4 23
0218 BNE F4     D0 F4
021A SEC        38
021B LDAZ 21    A5 21
021D SBCZ 22    E5 22
021F BEQ 0F     F0 0F
0221 BCC 0A     90 0A
0223 LDAZ 21    A5 21
0225 STAZ 22    85 22
0227 STYZ 20    84 20
0229 LDA #00    A9 00
022B STAZ 24    85 24
022D SEC        38
022E BCS 04     B0 04
0230 LDA 01     A9 01
0232 STAZ 24    85 24
0234 LDA #00    A9 00
0236 STAZ 21    85 21
0238 PLA        68
0239 TAX        AA
023A INX        E8
023B CPX Z23    E4 23
023D BNE C9     D0 C9
023F RTS        60

```

The following locations are used by 'MODE':
Z20 = value (i.e. MODE)
Z21 = N1
Z22 = N2
Z23 = length
Z24 = error
For details see flow chart.

Assembler and machine code program for the Z80.

Label	Source	Object
1800	LD A,00	3E 00
1802	EX AF,AF'	0B
1803	LD BC,(1902)	ED 4B 02 19
1807	LD DE,00 00	11 00 00
180A	LD HL,(1900)	2A 00 19
180D	PUSH BC	C5
180E	PUSH HL	E5
180F	LD A,(HL)	7E
1810	EX AF,AF'	0B
1811	EX AF,AF'	0B
1812	CPIR	ED B1
1814	JR NZ :LB1	20 01
1816	INC D	14
1817	EX AF,AF'	0B
1818	CF C	B9
1819	JR NZ :LB2	20 F6
181B	LD A,D	7A
181C	CCF	3F
181D	SUB E	93
181E	JR C :LB3	38 20
1820	JR Z :LB4	28 18
1822	LD E,D	5A
1823	EXX	D9
1824	EX AF,AF'	0B
1825	LD E,A	5F
1826	LD D,00	16 00
1828	EXX	D9
1829	LD D,00	16 00
182B	PDP HL	E1
182C	POP BC	C1
182D	INC HL	23
182E	DEC BC	0B
182F	EX AF,AF'	0B
1830	LD A,00	3E 00
1832	CF C	B9
1833	JR NZ :LB5	20 02
1835	EX AF,AF'	0B
1836	RET	C9
1837	EX AF,AF'	0B
1838	JR :LB6	18 D3
183A	EXX	D9
183B	LD D,01	16 01
183D	EX AF,AF'	0B
183E	JR :LB7	18 E8
1840	EX AF,AF'	0B
1841	JR :LB8	18 E6

where d_j is the individual noise duration and t_j the individual time between pulses. We can see that if a noise pulse occurs once between the times t_a and t_b it could have occurred a total of b times equal to $(d_m+t_m)/d_m$. The probability that noise will occur at any one time is the inverse of b, i.e. $d_m/(d_m+t_m)$. The longer we extend the listening period, the more likely we are to get a noise pulse ($\rightarrow 1$). So the probability that our range measurement is true will tend towards 1-b. There are no controllable

parameters because noise is random. However there is a way to overcome this and introduce control into the range measurement. If the maximum range of the measuring system is 1m, then the time taken to take a measurement is 6.06ms. We are using an 8-bit counter to measure the distance so we can measure in 255 increments of distance. If the measured distance is 255 then we call this an over-range reading and ignore it, for safety. So if the true distance is R, the time taken to make the measurement is $6.06R/254$. The chance that a noise pulse is received in this period is 1/R and if we combine this with the probability of a noise pulse being detected at any time 1/b we get $1/bR=d_m/R(d_m+t_m)$. If we call this P for probability and then if we make two such measurements then the probability that there will be a noise pulse detected during both periods becomes P^2 and if we make a large number of measurements then the probability that if I is the number of measurements that are identical, then the probability that these are due to noise, P_I is equal to P^I . I is the number of identical range values and is partly controllable depending on the number of measurements taken. If P_I is the probability that I identical values are due to noise, the probability that these readings are in fact the true range measurements is therefore $1-P^I$, or $1-(d_m/R(d_m+t_m))^I$. The effectiveness of the system thus depends chiefly on the number of readings taken, but it may also be possible for the computer software to determine the values of d_m and t_m , i.e. the duration and spacing of noise pulses and then optimise the number of readings taken. This could vary with different environments. A further refinement could be for the robot to move the sensor a specific distance, take another set of readings, and then confirm the first set by comparison, taking into account the offset caused by the movement.

Non-industrial robots

People are designing robots to solve specific problems in areas where immediate financial benefit is likely. But areas where financial gain appears unlikely at present, are not being researched very enthusiastically. It is in this area that amateurs can be of great help, by designing and discussing their own robot projects and experiments. Robots made for personal scientific interest and curiosity are bound to be more far-reaching in scope than so-called robots built merely as an economical answer to a tricky engineering problem. The author would like to hear from readers who are pursuing the subject of robotics from a hobbyist viewpoint, in an attempt to make some real progress in a field which might be called "non-industrial robots". Readers interested in forming a non-industrial robot group can make contact at the following address:

H. W. Gleaves
20 Hartington Road
Liverpool 8, L8 0SG

Test yourself in circuit analysis

Here are the answers to Wes Vincent's circuit analysis quiz on page 43.

- 4V
- 6V
- 7mA
- 21V
- 3V
- 1.5kΩ
- 5mA
- 1kΩ
- 2.8V
- 0.4V

Count the number you answered correctly and compare below.

- 10 Congratulations! You pass as an expert
- 8-10 Above average
- 6-8 Average
- 4-6 Below average. Review the concepts presented in the article.
- <4 Well below average. Review this article at a later date and try the quiz then.

An electronics engineer at Delco Electronics division of General Motors, Kokomo, Indiana, Wes Vincent designs integrated circuits for automotive electronics. He is typical of *Wireless World* readers in enjoying electronics as a hobby, and says he wrote the article "to help the hobbyist, technician and practising engineer to sharpen their skills with respect to circuit analysis".

John Wiseman

John Wiseman, born 1931, Melbourne, must be an expert on South America: he's spent years "wandering about" Argentina, Brazil, Chile, El Salvador, Guatemala, Honduras, Mexico and Uruguay, supporting himself by translating pieces for the Australian press from Allendes Chile. As a freelance radio officer based in London on foreign-flag shipping the offer of a very cheap sea passage to Buenos Aires proved irresistible. It was boredom of working as a radio operator off the Australian coast that had previously led him to change course and take up teaching, fleeing to Europe when he'd saved enough money.

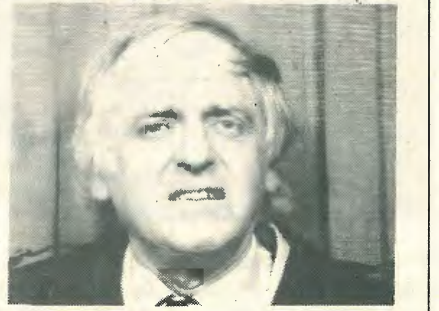

Back in the antipodes in the mid-seventies, a "very bad experience in a storm" in the Bass Strait - between Tasmania and the mainland - concentrated his interest in aerial design. And taking up aerial matters with the radio surveys ministry found him up against a "never wrong" bureaucracy. "So I bought a camera" he explains, "and started to photograph some of the atrocities such bureaucrats have given their approval to". This resulted in articles in *Safety at Sea*, *Nautical Review* as well as *Wireless World* (see "Transmitting aerials of modern merchant ships" September issue, "Practical problems with aerials at sea" March issue with subsequent letters, and "Aerial inefficiency at sea", page 29 this issue). 1983: Further time in the UK, he tells us, "has been vetoed by the Home Office".

Hobbyist's spectrum analyser

Television tuner module and oscilloscope form the basis of this useful and versatile piece of test-gear

Home experimenters occasionally have a chance to lift their activities to a new and previously unattainable level. The catalyst here is the voltage-controlled variable capacitance diode television tuner and the piece of equipment is the spectrum analyser. This article looks at these tuners and their power supply requirements in some detail and shows how to take the first steps toward a practical 'backyard equivalent' of the expensive all-singing all-dancing commercial spectrum analysers. This project is one where results can be obtained almost from the beginning and where each stage can provide the facilities for building and checking the next. The final result should be limited only by the patience, care and enthusiasm of the constructor.

But first of all, what is a spectrum analyser and what can it do? Essentially it shows an instant picture of the position and the strength of every signal in a selec-

by Roy Hartkopf

ted frequency band. It shows what radio and television stations are on the air, their strength and frequency. It instantly detects spurious or harmonic radiation from the oscillator you built or from a transmitter. It can help to trace and identify electrical noise and interference, and it can make the building and alignment of filters and

Fig. 1. Power and control-voltage supplies for the tuner module. Tuner is swept across its range by a waveform derived from the timebase of an oscilloscope; after rectification its i.f. output is applied to the vertical deflection input. Network at the collector of Tr₁ provides correction for the non-linearity of the tuner's tuning characteristic.

high frequency amplifiers a matter of minutes instead of days.

The principle on which the spectrum analyser works is simple. By applying a sawtooth waveform, preferably taken from the oscilloscope itself, to both the oscilloscope deflection circuits and the tuner we cause the tuner to sweep over part or the whole of its range in synchronism with the spot moving across the oscilloscope screen. At the same time a rectified output from the tuner is applied to the vertical amplifier of the oscilloscope causing a vertical spike to appear at any frequency where there is a signal. Since the height of this spike is proportional to the strength of the signal we have a picture or panorama of all the activity in this frequency band.

One cannot work entirely without tools and the major requirement in this case is an oscilloscope. The simplest home-made one will do because although we may be

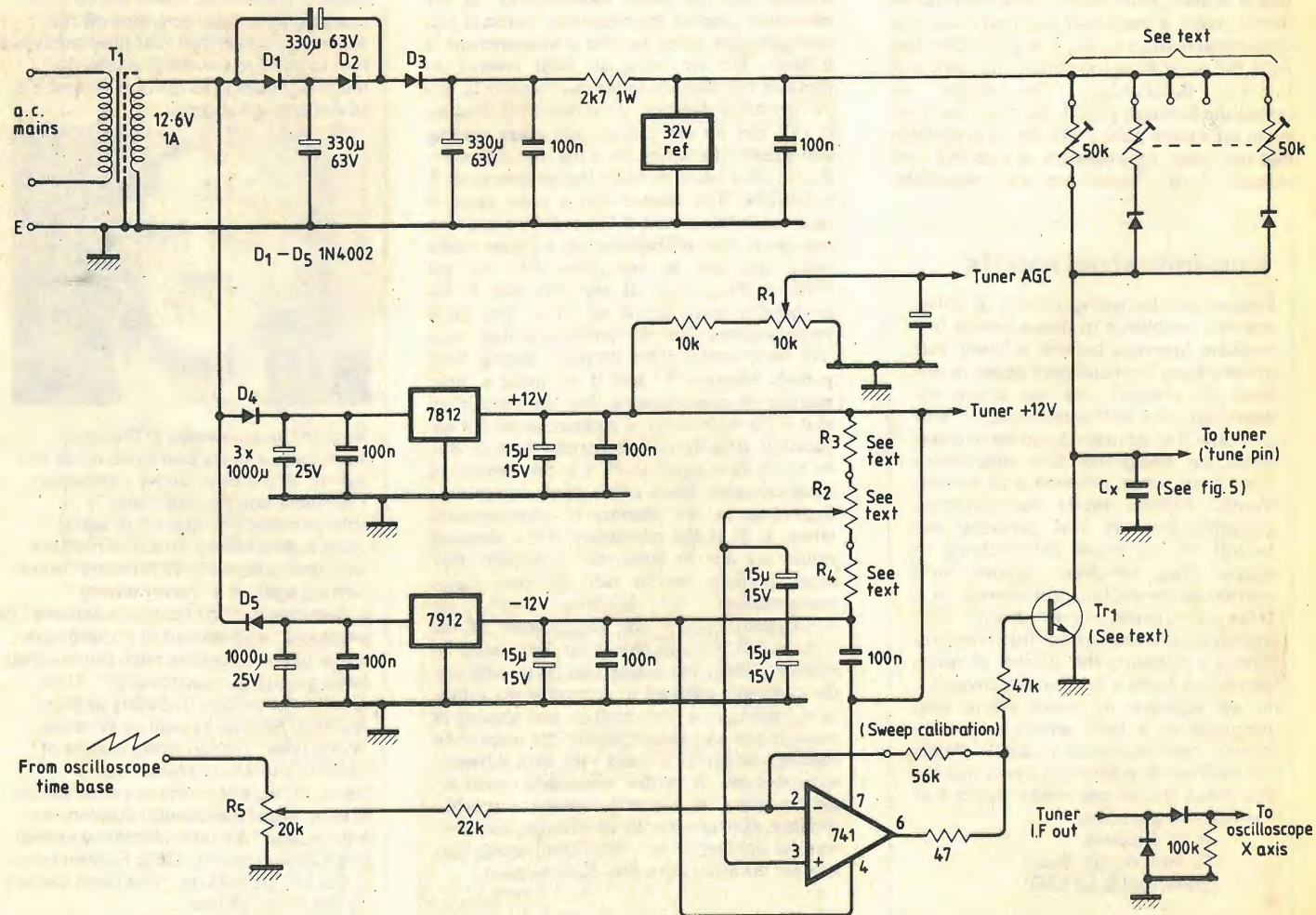

viewing frequencies of hundreds of megahertz the oscilloscope is coping only with rectified a.c. and the sweep should be as slow as possible. About 25 sweeps per second will be fast enough to avoid too much flicker.

The other major item is the television tuner itself. It must of course have voltage controlled tuning and preferably cover both the v.h.f. and u.h.f. television bands. The most useful bands are from about 100-220MHz and 450-850MHz. The tuner mentioned in this article is a Philips ELC2060 but any other type could equally well be used.

Once the printed circuit board is made the assembly of the components should be done in stages, beginning with the power supplies. The 12 volt positive and negative supplies are quite standard and since the current required from the negative supply is likely to be very low — even allowing for future additions — only one 1000µF capacitor was used for smoothing. The third supply is used for the voltage-variable capacitor tuning and consists of a tripler circuit which generates about 50V. The voltage used for tuning must be extremely stable: a voltage change of about 25V tunes the u.h.f. section over 400MHz, a rate of 16MHz per volt; so a jitter of even 1mV will cause a frequency jitter of 16kHz. There are integrated-circuit voltage stabilizers specially made for television tuners and a typical one is the TAA550, a two-lead device in a TO-18 case. The positive lead is connected to the case so be careful about shorts when using a heat sink. With a small clip-on heat sink the device will carry about 6mA comfortably and drop about 32V. It is the stability, not the voltage, which is critical. To prevent any possibility of the TAA550 dropping out of regulation it is wise to allow for a minimum current of a couple of milliamps to be flowing through it at all times. This leaves about 4mA as the maximum which

can be drawn by transistor Tr₁, so the load resistor should be at least 8kΩ. On the small plug-in board we can temporarily set one of the trimmers (the one which has a wire link in series rather than a zener diode) to 8kΩ and, without soldering in any of the zener diodes, plug the board into its place.

The range-setting resistors R₃ and R₄ have to be adjusted and it is necessary to substitute two trimmers to determine the final values. Use two 100k pots, set them about mid-range and solder them to inch-long tails of wire which can be soldered into the holes for the resistors. Any trans-

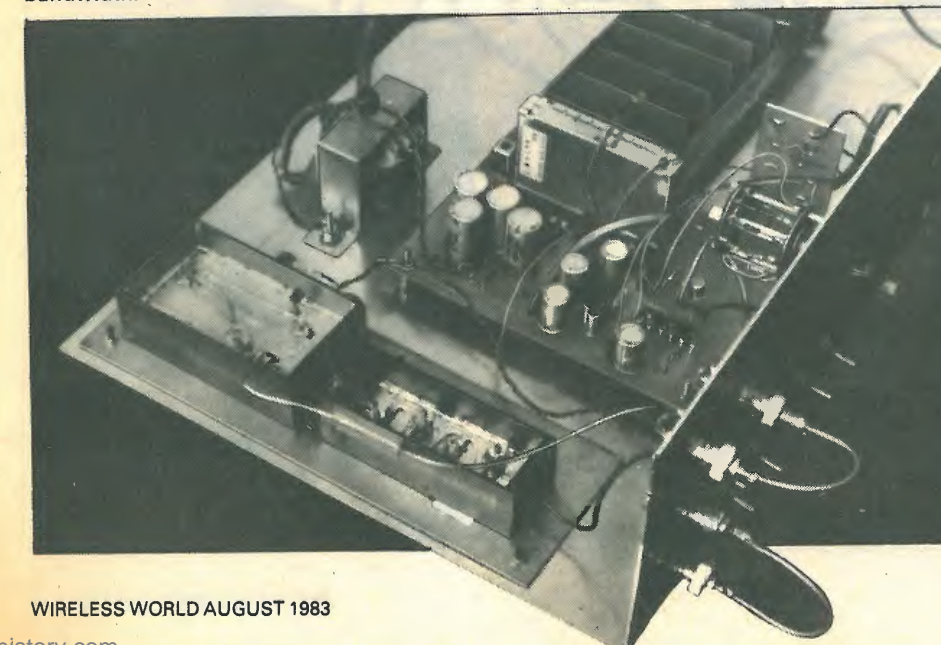

Simple comb generator

The comb generator gets its name from the fact that the pattern it produces on a spectrum analyser resembles an ordinary hair comb with its prongs pointing vertically upward. Because these 'prongs' are harmonic multiples of the fundamental frequency it follows that the frequency difference between each one and the next must be exactly the same, the same as the fundamental frequency of the oscillator. So if they are evenly spaced across the screen we can be certain the sweep is linear (except for possible variations between the spikes, so the more spikes within reason the better). If we know the fundamental frequency we can get a quick indication of the total range of the sweep and if we also know the frequency of any individual spike we can use the comb as a 'frequency ruler' to measure any other signal.

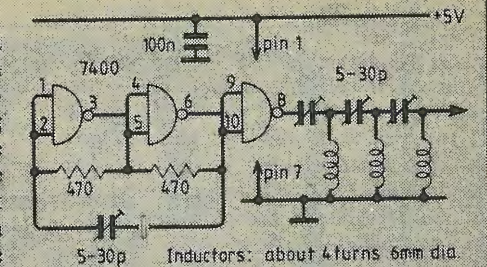

Electrically the comb generator is just an oscillator. But where normally we try to get a clean signal and suppress the harmonics here we try to produce as many as possible. We make a high pass filter by feeding the output through two or three (or more) small capacitors in series with inductors. Choose a convenient frequency for the oscillator (e.g. 10, 20, 25 or 50MHz) and fiddle both the capacitors and inductors while watching the result on the screen.

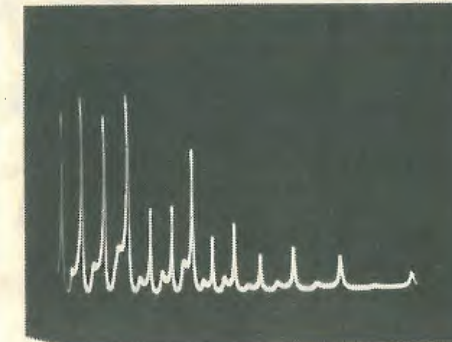
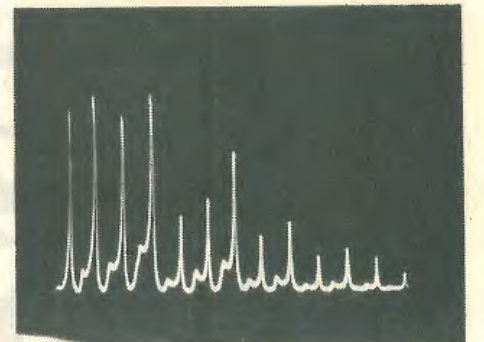

Fig. 2. Output from a typical comb generator as seen on the home-made spectrum analyser. Uneven spacing between the 'prongs' is corrected by adjustments described in the text; height difference is unimportant. Bumps at the bases of the spikes may indicate tuner overloading.

Fig. 3. Same comb as in Fig. 2, but after correction for linearity. Note improvement in spacing between the spikes on the right-hand side. Display covers 100 to 200MHz with 10MHz spacing.



sistor which will stand the 32V rail will do for Tr₁ but select one for a very low gain (50 or even less). A high-gain transistor can make subsequent adjustments impossibly critical.

Apart from the power transformer the only components external to the board are the v.h.f.-u.h.f. switch (if required) and R₂. R₂ is a critical component because it controls the centre position of the sweep. A good quality 10-turn pot should be used; or if that is too expensive or hard to get use a ten turn trimmer, the kind used in presetting push-button television tuners. Otherwise the control will be too sensitive. R₂ sets the voltage applied to the non-inverting input of the op-amp; and the circuit is adjusted so that, with the slider of R₅ grounded, R₂ can vary the tuner voltage through the full range from 0 to 30V. This is achieved by adjusting the trimmers which temporarily replace R₃ and R₄ while measuring the voltage on the collector of

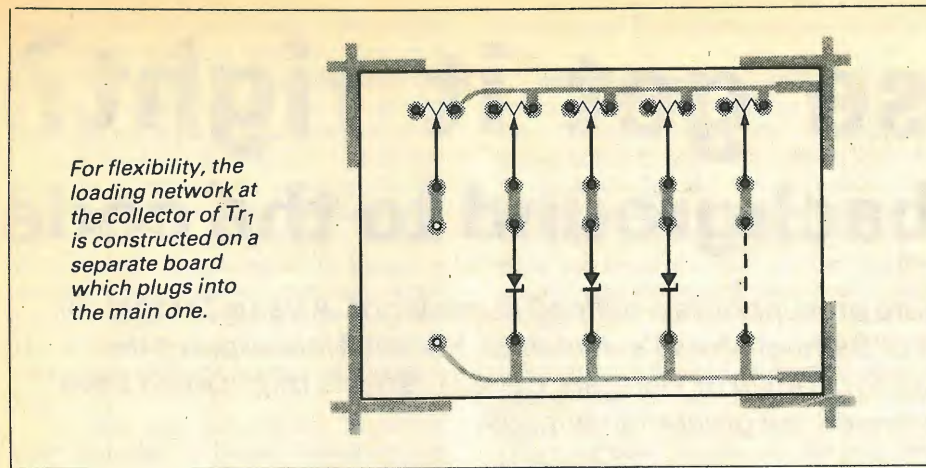
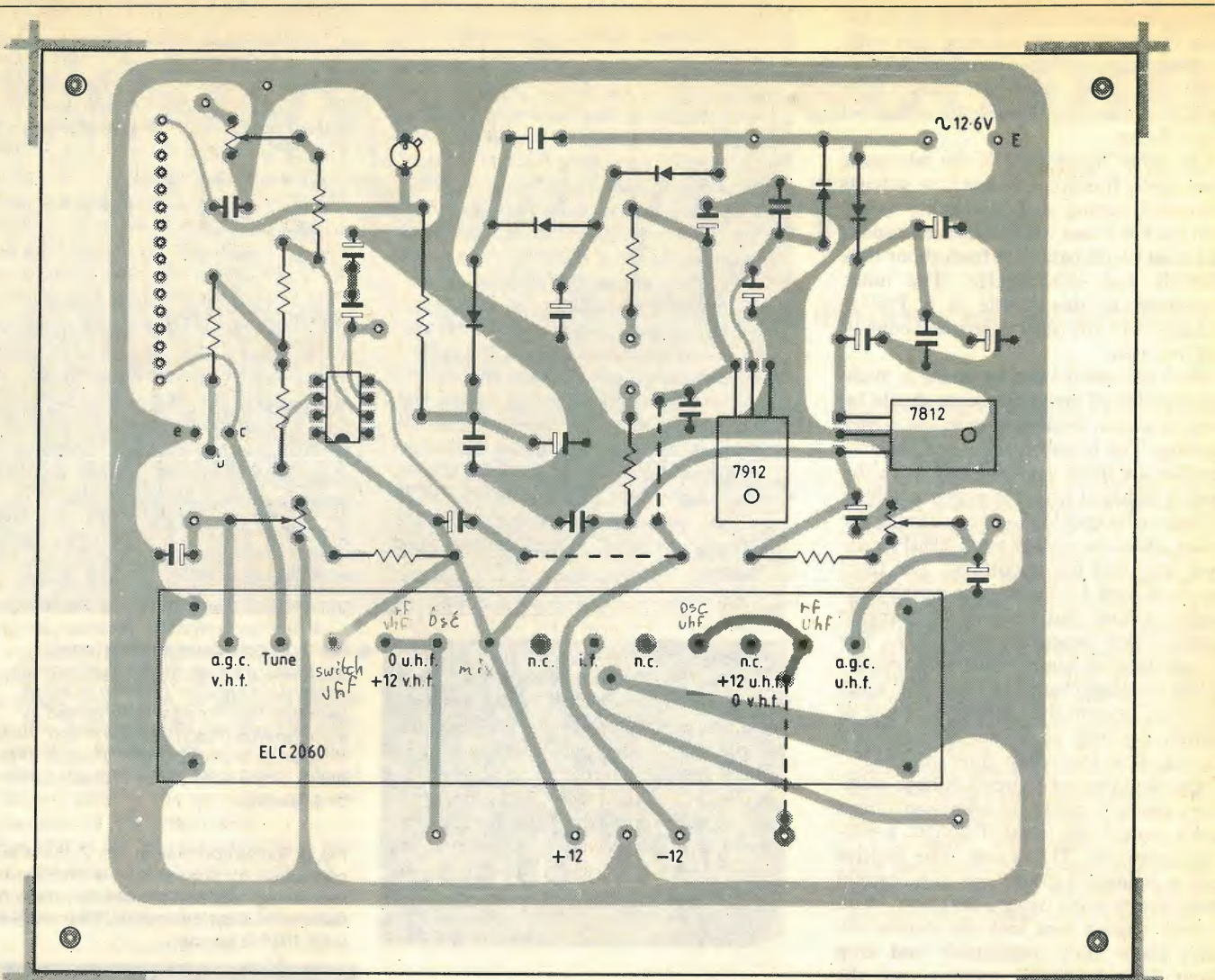

For flexibility, the loading network at the collector of Tr₁ is constructed on a separate board which plugs into the main one.

Tr₁. Remember to set the a.g.c. trimmer R₁ to give about 2.5V to the tuner a.g.c. pin (or pins as the case may be). Finally make up a rectifying circuit with a couple of signal diodes and a 100Ω resistor as shown in Fig. 1 and connect it between the tuner output and the oscilloscope probe. Having connected the sawtooth waveform driving the oscilloscope to R₅, set the sweep to a very low speed (about one sweep every five seconds), put the voltmeter on the collector of Tr₁ and adjust R₅, the shift control R₂, and if necessary, everything else, until the tuner control voltage is sweeping through the full 30V. Then increase the sweep frequency enough to give a readable trace and put a signal within the frequency range into the tuner. One or more spikes on the trace should show that the first stage of your spectrum

analyser is working. The next job is to make a comb generator (see box 00). When this is connected to the tuner the display should resemble that shown in Fig. 2. The main purpose of the comb generator is to help in optimising the linearity of the sweep. Note how in Fig. 2 the spikes are crowded together at the left and spread out at the right. This indicates that the same control voltage change causes more tuning shift at the beginning of the sweep than the same change causes at the finish. To put this right, zener diodes are fitted to the small plug-in board to modify the load resistance for Tr₁. As the voltage across the load increases the diodes will successively conduct, reducing the load resistance and compensating for the increased frequency-to-voltage sensitivity.

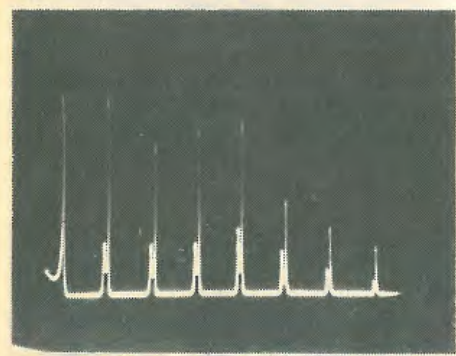

The same linearity correction should be effective on more than one band. This shows a u.h.f. display from 500 to 850MHz with 50MHz spacing.

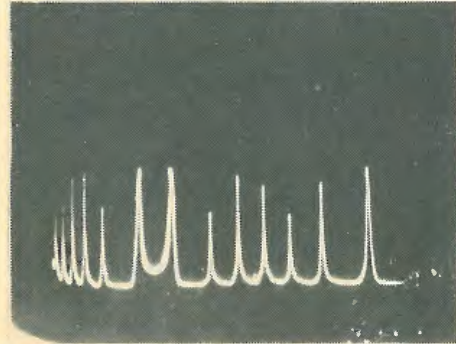

If the oscilloscope sweep speed is too fast, as it is here, the tuner frequency may still be dropping when the next sweep begins. This can arise because voltage-controlled tuning circuits usually incorporate some capacitance for stability, for example, C_x in Fig. 1.

screen is clear and reduce the resistance of the trimmers in series with the 15V zener diode. If the value of the zener is correct then all the harmonic spikes except the last two on the right should move to the left. If either of the last two moves the zener voltage is too low. Try one of, say, 18V. If three or more of the right hand spikes do not move, the voltage is too high. When you get the voltage correct, adjust the trimmer until the third spike from the right has exactly the same spacing as the first two. With any luck the fourth may also now be correct.

Continue in exactly the same way with another zener diode, selecting one which shifts only the spikes not already spaced correctly, until the display is similar to that shown in Fig. 3. If you are very unlucky and the tuner has both v.h.f. and u.h.f. ranges you may have to use a second plug-in board for the other range; but in every case experienced so far (several tuners have been tried) the same compensation settings are adequate for both ranges. The more zeners and trimmers used, the more accurate the correction; but three are usually enough, at least for a first attempt. As a final check, make sure that with all zeners conducting the load current is about 4mA. If it is more and the regulation is dropping out then increase the level at R₅ and try again.

The basic spectrum analyser is now complete, although it still has a number of limitations. It is uncalibrated, it is not very sensitive, it has a restricted frequency range and the i.f. bandwidth is too broad for some applications. But by progressive additions such as switched bandpass i.f. filters, a logarithmic amplifier to improve the sensitivity and the range, heterodyne mixers to extend the frequency range and a calibrated variable sweep the final result could be limited only by the patience and enthusiasm of the constructor.

The ELC2060 tuner is available for £8.63 including inland postage and v.a.t. from Sendz Components, 63 Bishopsteignton, Shoeburyness, Essex SS3 8AF. WW

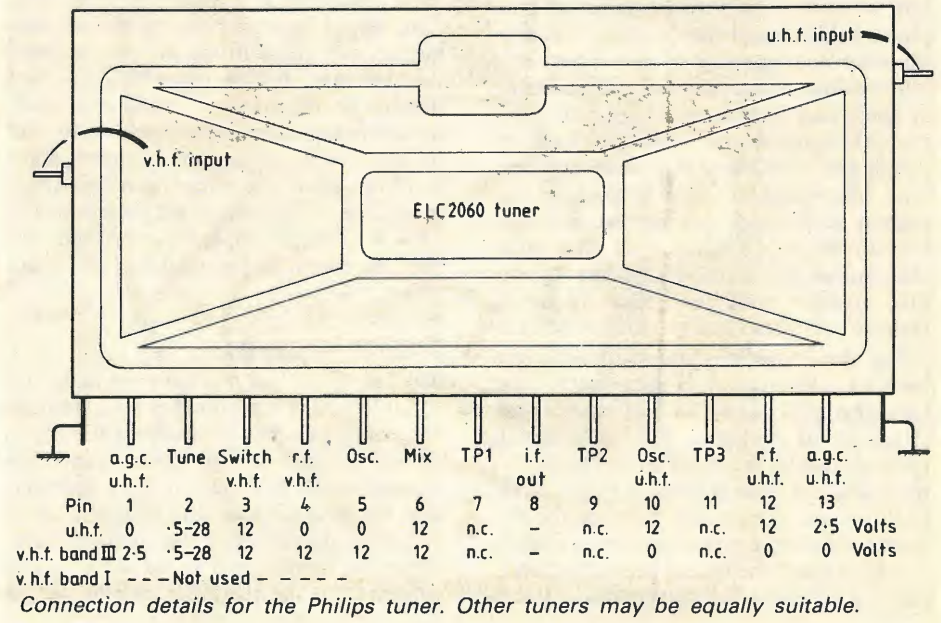

Did Morse get it right?

A statistical background to the code

Morse speed in words-per-minute presupposes a defined mean word. A value for this can be derived from an analysis of Samuel Morse's own data. Recent trials support the original work for English but not for French or German. Certain aspects might even have surprised the great man himself.

Morse code must be reasonably familiar to most readers of *Wireless World* but some of the finer points of its structure and certain practical difficulties in its application might not be immediately obvious to the non-specialist. In particular, there is an inherent uncertainty in relating transmission rate to the more traditional measure of words per minute. The last-mentioned introduces the concept of a standard word length which must be statistically derived from an analysis of plain language text, and the results may differ significantly between one language and another. This article looks at present-day practices and relates these to statistical data available for English and five other European languages. The need for such a reappraisal can be justified by the increasing use of automatic keyers, practice code generators and the like, which, with their capability for greater precision in code formation, has led to a general desire to define transmission speed more closely and more uniformly than has been the custom in the past.

Statistical beginnings

By the early 1830s Samuel Morse had become fully aware of the potential that a variable code would offer in arranging shorter combinations of signals to be allocated to the more frequent letters of the alphabet and it is recorded¹ that a visit to a local newspaper printing room enabled him to deduce from the number of type pieces held for each letter of the alphabet the relative frequency of use. From this information, Morse devised combinations of short and long signals specifically designed to maintain the product of character length and frequency at a more constant level than would otherwise be the case, and thereby to produce the shortest messages overall. Morse's original code (not quite the same as that in use today, see Appendix) together with the letter frequency table he compiled are given in Reference 1.

For the immediate task of providing a basis for calculation, it is necessary to state here the parameters of the mark-space structure as follows. The dot length (period) can be regarded as the basic element and the dash is given a length equal to three dots. The spaces between the elements within one character are equivalent to one dot and the spaces between characters are given three dots duration. Words

are separated by seven dot elements. For brevity, the term bit is used synonymously with dot element making the dot rate equal to half the bit rate (baud or bit per second).

The length of a morse character can be expressed in terms of the number of dot elements or bits it contains: for example, the letter A (dot dash) can be said to comprise five bits. However, as one character cannot follow another without inserting a space of some kind, it is preferable to in-

clude the standard inter-character space (three bits) as part of the letter itself bringing the letter A to eight bits, alphabet shows a range from four to 16 with a mean value of 11.23 bits. The full range of bit counts is given in the Appendix.

Random code

When letters are selected at random they appear, by definition, at uniform relative frequency and a mean five-letter word in code is equal to five times the mean letter plus four bits to make up the remainder of the word space. Taking a rounded value for the mean letter as 11.2 bits, the mean word comes to $5 \times 11.2 + 4 = 60$ bits. Code speed in words per minute is then numerically equal to the bit rate or twice the dot rate. Figure characters also can usually be regarded as random in their occurrence and a similar analysis to that for letters gives the mean character length as 17 bits from which the mean five-figure group (including word space) comes to $5 \times 17 + 4 = 89$ bits. Speed in word/min can then be shown to be equal to $1.35 \times$ dot rate.

English language

The fact that plain text does not make use of all letters of the alphabet with uniform frequency presents the major difficulty in setting a value for the mean (plain language) word. It is safe to say, however, that the figure is bound to be significantly less than the value for the random case, otherwise there would be no benefit to be gained from the use of a variable length

code and, in fact, the ratio of the two figures can be regarded as a measure of achievement in optimizing the design.

Before going on to report the results of trials it must be conceded straight away that a standard word for a plain language does seem to have established itself already: a scrutiny of published material shows a consensus for a nominal standard of 50 bits (including word space) and the word 'Paris' is sometimes quoted as representing this value. Frequently the information is given directly in terms of word/min and dot rate as, for example, word/min = $2.4 \times$ dot rate (1 word/min = 50 $\frac{1}{60}$ baud). Seldom is the reader provided with any basis for the figures quoted and variations do appear from time to time not only in the literature but in the observed calibration of automatic keyers and practice tapes.

It was against this background that I felt the need to satisfy myself that any standard being quoted, and in particular the 50 bit word, had a reasonably sound statistical basis for its application and had not established itself merely by common usage. At the same time, it had to be admitted that,

E' E' E' E' E E E E
C' C' C' C' C' C' C' C
A' A' A' A' A' A' A' A

F' D' B'	4	2					1	1
F' D' B'								
F' D' B'								
F' D' B'								
F' D' B'								
F' D' B'								
F' D' B'								
F' D' B'								

Clues

B' D' E' F' = 6	A' B D F' = 6
B' D E' F' = 4	B' D E = 6
B D E F' = 6	A D' E F' = 3
B D E F = 6	C E F = 8

Crossword - by N. Darwood

Using the digits 1 to 8 each row and each column adds up to eight. The first clue, and its consequences for the top row, is given. No entry need be guessed. Solution next issue.

even if a 'better' result were to be found, there might still be a case for retaining a round figure such as 50 bits in the interests of easy standardization, providing the figure did not depart too far from reality.

To derive a standard word for plain language it is necessary to combine the bit count for each letter with its relative frequency of occurrence to obtain a measure of the overall effectiveness of the letter in a long run of text. Relative letter frequencies must, of course, be estimated by statistical trial and in the first instance I selected three quite different sources of available data.

The first was the original frequency table¹ compiled by Samuel Morse around 1830 and reproduced in ref. 1. The second was taken from a work² on cryptography by H. F. Gains first published in the late 1930s, which not only provided two sets of data by different analysts (Meaker and Ohaver) on English but data on five other European languages as well. The third was obtained during correspondence following publication of an article³ by a beginner operator describing his attempts to relate the dot rate on his automatic keyer to the amateur radio morse test at 12 word/min. It was not in the least way possible to foretell what the outcome of the exercise might be, but in the event the results proved to be so gratifying that I undertook a count of letter frequencies myself to provide extra data for analysis. The method used for this exercise and the results obtained are given at the appendix.

Given suitable data on letter frequencies, the procedure to determine the length of the standard word was the same for all sources of material. For all letters designated r_1 to r_n the product of bit count x_r and frequency f_r gave a table of values from which an overall mean letter size could be calculated. In the usual notation, the mean value x is

$$\bar{x} = \frac{1}{N} \sum_{r=1}^n x_r f_r$$

where N is the size of the sample. Defining the mean word as comprising five mean letters plus four extra bits to make up the word space, a value for the standard word was calculated. The results of the exercise using letter frequency data from the five sources listed are given in Table 1. The total dispersion of the mean over the five results is gratifyingly small considering the wide differences in source and sample size. A global mean value for the mean word comes to 49.4 bits and is unchanged (to three significant figures) when the data points are restricted to the middle three values.

Other languages

In addition to two sets of data on English, reference 2 provides letter frequency tables for five other European languages. The exercise to find a value for the standard word was extended to include these languages and the results obtained are given in Table 2. Data for French, Italian and Spanish were compiled from a count made by the author, but the origins of data for

German and Portuguese are said to uncertain.

The results show significantly low values of the mean word for French and German relative to the other language trials, including English. This seems likely to be due to the fact that the frequency table for German shows zero count for letters J, Y, Q, and Z (all long symbols in morse) while the count for letter E (the shortest symbol) was the highest encountered over all languages. The relatively low value for French cannot be so easily explained with zero count for K and W (letters of around average size in morse) but a fairly high count for E. Spanish and Portuguese, producing equal results, are the only two languages in the six tested to show a mean word exceeding 50 bits.

The standard word

Results for English show a value for the mean word estimated over five trials as 49.4 bits with an overall dispersion of +0.4 to -0.3 bit. There can be little doubt therefore that a standard word of 50 bits will meet all normal requirements for the measurement of morse speed in English. Of the five other languages, Italian, Spanish and Portuguese all show values for the

mean word within $\pm 1\%$ of 50 bits which value can be accepted as the standard for these languages also, albeit on the basis of smaller samples.

Table 1. Results of five independent trials to determine the mean word for English.

Origin	Sample size	Mean word (bits)
Morse	106,400	49.8
Gains (Meaker)	10,000	49.5
Gains (Ohaver)	10,000	49.3
Chester	10,000	49.3
Wood	1,798	49.1

French and German deviate much more from the 50 bit standard at -4.8% and -7.4%, respectively, and it may be worth considering whether any additional trials should be undertaken on these languages to verify the low values obtained from the published data used.

Given a standard word length of 50 bits, the word Paris is often used to represent this value. Whether it is really necessary to quote an actual example of a 50 bit word is debatable but there must be other internationally recognisable words of this length

Morse symbols and bit content including inter-character space together with frequency count. Taken from the *Sunday Times* of 18 July 1982 using a wide range of material by different writers. But specialist subjects were avoided, as were passages containing undue repetition of proper names and

frequent use of foreign words. The combined result is from a total sample of 10,000 letters. Following the style of Gains, relative frequencies are given as the percentages of the sample while dropping the decimal point gives the actual count.

Letter	Morse symbol	Bit content	Relative frequency
A	.. ---	8	8.25
B	--- --	12	1.78
C	--- .--	14	3.14
D	--- --	10	3.38
E	..	4	12.77
F	.. ---	12	2.38
G	--- ---	12	2.04
H	--- --	10	5.06
I	.. --	6	7.03
J	.. --- ---	16	0.19
K	--- .--	12	0.58
L	--- ---	12	4.30
M	--- ---	10	2.29
N	--- --	8	7.02
O	--- ---	14	7.13
P	--- ---	14	2.03
Q	--- ---	16	0.14
R	--- --	10	6.30
S	--- --	8	7.06
T	---	6	9.17
U	--- ---	10	2.83
V	--- ---	12	1.20
W	--- ---	12	1.80
X	--- ---	14	0.28
Y	--- ---	16	1.76
Z	--- ---	14	0.09

* On this basis a bit count for all the letters of the ...
62 red: WW sept 83 pag 62

from which to choose. It was during a search through a list of suitable candidates for an alternative to Paris that I stumbled on the fact that the word Morse is one of precisely 50 bits (including word space) and, being more than relevant to the

Table 2. Results of trials to determine the mean word for the five European languages given.

Language	Origin	Sample size	Mean word (bits)
German	Uncertain	Not given	46.3
French	Gains	10,000	47.6
Italian	Gains	10,000	49.7
Spanish	Gains	10,000	50.4
Portuguese	Uncertain	Not given	50.4

subject in hand, could hardly be bettered as an international standard.

Morse practice and test criteria

Traditionally, morse speed for plain language transmission is estimated by marking off groups of five letters in a passage of text (ignoring word spaces) and then sending the passage normally arranged in groups of five and the counting of 'words' is then straightforward. It is common practice to send code at a rate some 20% lower than that for plain language with the intention of presenting the same overall degree of difficulty to the operators. Whether this practice is entirely justified is arguable but a quantitative measure of one aspect of the problem is given in the following paragraphs.

Table 3. Standard words for three categories of morse against corresponding wpm/dot rate (dot rate in dots per second = half a bit rate).

	Plain	Code	Figures
Standard word (bits)	50	60	89
Ratio wpm/dot rate	2.40	2.00	1.35

Given a standard word length for each of the three categories of morse, it is simple to find the corresponding ratio of transmission speed in word/min to dot/s. Table 3 gives standard word lengths derived from the data produced in this article with the required ratio. The dot rate for plain language can be adjusted down if necessary by 1% since the mean word length for English estimated by trial has been found to be about this much short of 50 bits. For certain other languages, the dot rate could be much greater in error; see the results for these in Table 2.

When using automatic keyers, the dot rate can readily be set to a level corresponding to the required word speed. In such cases, it may be useful to remember a few equivalents such as 24 word/min in plain language corresponds to 10 dot/s. It is also interesting that this same dot rate will produce a speed in code of 20 word/min and on this basis a combined morse test in plain and code would have to be sent at word speeds in the ratio 24/20 to represent the same 'pace' to the operator. The method, however, would not take into account the difference in letter predictabil-

ity between the two categories of text and it could be argued that if plain text in the operator's own language is easier to copy than random code at the same dot rate, then the word-speed ratio between the two should be *increased* to redress the balance. Unfortunately, this aspect is difficult to quantify and seems to depend on the individual operator's training and experience.

An exercise which started out to test the validity of the 50 bit standard word has shown the figure to agree with the result of statistical trials to within about $\pm 1\%$ for English and three other European languages. But unfortunately, the standard doesn't seem to fit the German or French languages as well as the others and users in these countries may wish to consider whether conformance to a round-figure standard is more important than precise alignment with the result of one statistical trial. More generally, and especially for non-European languages, the problem of the standard word can be avoided altogether by the universal adoption of dot rate as the only reliable measure of the 'pace' of transmitted morse.

References

1. C. Cherry, *On Human Communication*, p.35. Wiley, New York; Chapman & Hall, London.
2. H. F. Gains, *Cryptanalysis*, appendix. Dover Publications. 1956 New York.
3. I. T. Wood, *The true measurement of morse speed*, *Short Wave Magazine*, vol. 39, February 1982. WW

NEWS

Liquid crystals add colour to monochrome c.r.t.

A solution to the problem of producing colour display devices with a high enough resolution for measuring instruments and computer displays has been developed by Tektronix in the form of a monochrome c.r.t. with a two-colour liquid crystal switch. This is not the first display of its kind, but the developer claims to have solved the problem of colour-switch speed. Tektronix manufacture their own tubes and the liquid crystal switch is described as 'proprietary' but Fred Rose, information officer of Tektronix UK, could not tell us in plain terms whether or not his company manufactures the device. "We have tried to clear up one or two ambiguities" he said, "but Tektronix are not prepared to release any more details. The display is ready to be used and I speculate that we could see it incorporated in one of our products within the next twelve months."

The display has the same resolution as current monochrome tubes and does not suffer from convergence problems. A high contrast ratio is claimed, as is ruggedness through the absence of a shadow mask and complex gun, but Tektronix are not so clear about the price of such a display and will only say that it is "potentially low cost." Phosphor coating on the tube is plain with two separate emission peaks that are typically, but not limited to, red

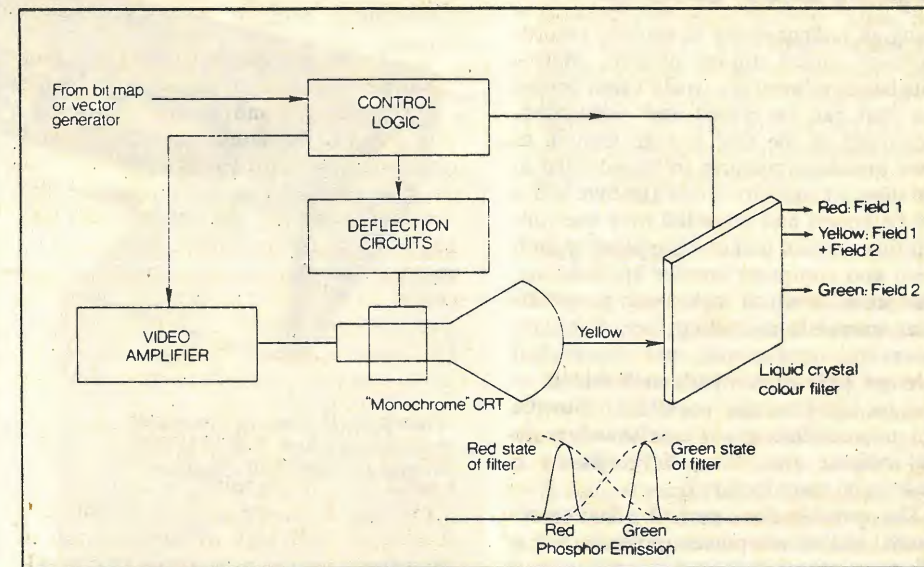

and green. In any field, information written on the screen appears in the colour selected by the electronic switch. Each colour is repeated at 60Hz, requiring the two-field system to run at 120Hz. This field-sequential system provides all possible mixtures of the two primary colours emitted by the phosphor and research is continuing to extend the concept to three fields to produce the full colour spectrum.

Colour displays for measuring instruments and computers with the resolution of current monochrome instrument tubes could appear within the next twelve months. Tektronix have developed a system combining a fast liquid-crystal filter and monochrome c.r.t. to provide a high-resolution display producing all colours between red and green on a field-sequential basis. Research into producing a three-colour version continues.

Electronic mail-order for electronics

Items from the large component catalogue issued by STC Electronic Services can now be ordered electronically. A new service called Estelle allows direct access to the company's mainframe computer at Harlow for any customer equipped with a suitable modem and a computer or v.d.u. having an RS232 port. Estelle (a somewhat tortured acronym standing for Electronic Services telephone link for order entry) claims to be the first system of its kind introduced by a major components distributor. Users can obtain up-to-the-minute information about product availability and pricing and may place orders straight away or else browse through catalogue items. A menu system enables them to find their way about. The service is aimed not only at business and industrial customers: the company is keen also to attract the hobby-

ist, who can gain access with a home computer linked to a low-cost acoustic modem and pay for goods by typing in a credit-card number.

Services similar to Estelle, although perhaps less comprehensive in scope, are available from two retailers already well known to the hobbyist - Ambit International and Maplin Electronics. Ambit's Rewtel is predominantly an information service. It allows customers to make rapid searches of the company's database by typing in keywords; and the system responds by sending any pages containing those keywords in their heading. There is also an electronic bulletin board which allows customers to leave messages for the company or for other users. Component ordering and the several other facilities on Rewtel are available only to subscribers, who pay a fee of £10 per year.

The service launched by Maplin, called Cashtel (standing for computer-aided shopping by telephone), is available to Maplin's existing mail-order customers. To make a purchase the user enters the appropriate code numbers from the company's catalogue. Cashtel also allows users to check on stock levels and to follow the progress of their previous orders. Like the other systems it has features designed to ensure confidentiality and to protect

against misuse. Later on there is to be a bulletin board for private or public messages and an information service for various home computer user-groups: pages for Atari computer owners are already available. One attraction for potential Cashtel users is a modem offered by Maplin in kit form for less than £40: the modem conforms to the 300 baud CCITT standard and is transformer-coupled to the telephone line.

The telephone number for Cashtel is 0702-552941; and for Rewtel (300-baud Datel 200 service) the number is 0277-232628. Estelle is available on three numbers - 0279-443511 (300baud Datel 200 service); 0279-441188 (1200baud Datel 600 service); and 0279-441222 (1200baud Datel 1200 service).

Another company, Display Electronics of Thornton Heath, Surrey, though not a component retailer in the ordinary sense, can claim to have been the first in this field with its 300baud Distel service. This allows customers to search the company's large stock of computer and electronic goods and to order by credit card. Distel can be accessed 24 hours a day on 01-683 1133.

For further information, code WW500 (Estelle), WW501 (Rewtel), WW502 (Cashtel), WW503 (Distel).

Heatless laser etching

A new phenomenon has been discovered which allows organic polymers and biological materials to be etched by laser without heating. Called ablative photodecomposition by its IBM discoverer R. Srinivasan, the phenomenon could be used to directly etch images in photolithographic i.c. fabrication, which would greatly simplify the production process by eliminating the image development stage using photosensitive layers and chemical solvents. In the medical field, the phenomenon could mean precise laser surgery,

since cuts are determined solely by the geometry of the beam and, because heat produced is negligible, charring associated with laser surgery is eliminated.

Using far-ultraviolet lasers, Srinivasan found that an intensity threshold exists above which "numerous small molecules are suddenly ejected from the irradiated area of the material". High intensity is not directly responsible for the etching effect. Srinivasan believes that absorbed radiation probably breaks chemical bonds between atoms in the organic material producing

smaller molecules that vaporize at relatively low temperatures. These smaller molecules carry away excess energy from the laser pulse - hence the term ablative.

Pulses of 12ns at 1Hz or higher from a 193nm argon-fluoride excimer laser were used in Srinivasan's experiments. Other experiments using this type of laser have shown that ultraviolet radiation may be the key to submicron lithography.

Heatless laser etching could be used to directly etch images, left, in photolithographic i.c. fabrication, eliminating the usual image development stage using photosensitive layers and chemical solvents. This scanning-electron micrograph shows a commercial plastic film with 5µm-wide lines etched using a phenomenon known as ablative photodecomposition. With biological and polymer materials, a far-ultraviolet laser above a certain intensity threshold causes excess energy to be carried away in ejected molecules and the material remains cold.

Potential for heatless laser etching in medical applications, right, is illustrated by these cuts in cartilage tissue. Heating and charring caused by commonly used visible and infrared lasers, left, is not apparent in the 250µm-wide channel on the right which was cut using a far-ultraviolet laser and the ablative photodecomposition phenomenon. Geometry of the cut is determined solely by the beam geometry.

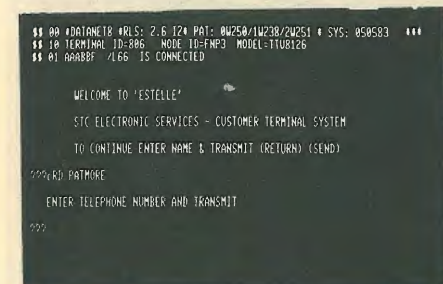
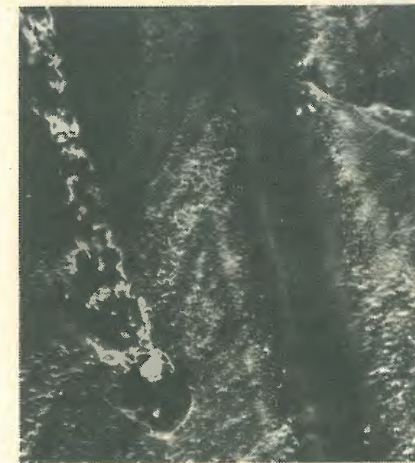
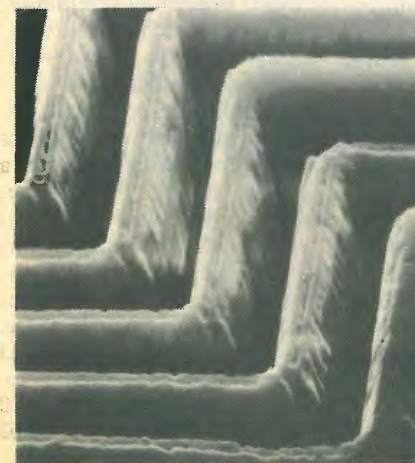

* in a given time. For random code letters are..

Erasable optical disc

Using an enhancement to existing record-playback optical storage systems, Matsushita has developed the world's first optical disc that can be erased and rerecorded. Sensitivity of the disc is high enough to allow broadcast pictures to be recorded in real time, its capacity is one gigabyte and it can be erased and recorded over one million times which makes it suitable for both video and computer storage applications. This would seem to make both perpendicular magnetic recording (see February News) and metal-powder tape obsolete but it is too early to compare such factors as cost-per-bit of storage, portability of media and manufacturing costs. Matsushita do not indicate that their development is ready to be manufactured.

The erasable disc, part of a \$600m research and development project, has a tellurium suboxide layer the same as used in existing optical-disc record/playback systems. Heating this layer results in it changing its reflective properties (see March News). But by adding metals such as germanium, indium and lead to the suboxide layer and using two separate laser beams, the change in reflectivity caused by changing the layer from a crystalline to

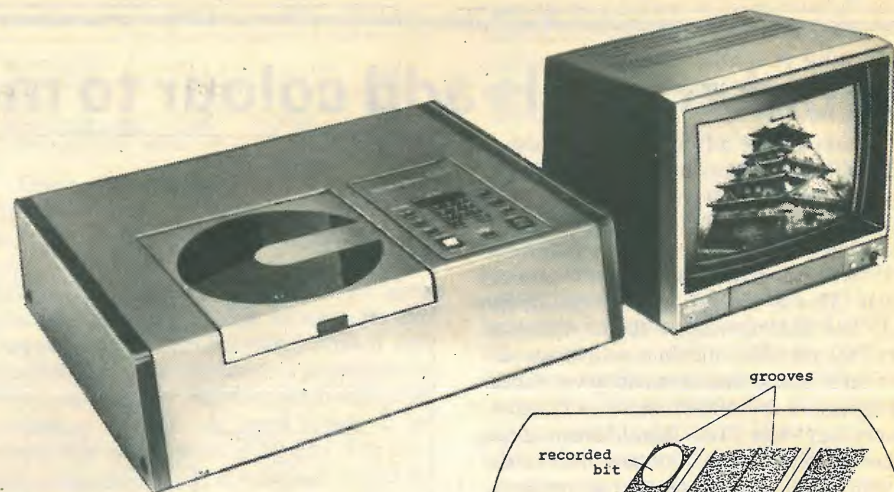

A Matsushita laser disc recorder that can play back one of 15 000 images in under half a second.

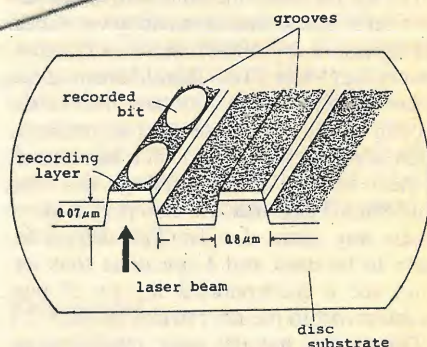

An erasable optical storage disc for video images and data developed by Matsushita uses two separate lasers for recording and erasing through a common optical system. The one gigabyte disc can record broadcast pictures in real time and be erased over one million times but when the disc might be available is not yet certain.

amorphous state is made reversible. In the record process the high-reflectivity crystalline phase is converted to a low-reflectivity amorphous state; during erasure, the opposite occurs. Two semiconductor lasers are used — a 0.83µm 8mW device for recording and playback and a 0.78µm 10mW type for erasure — with a common optical system.

Submillimetre-wave telescope

Work has begun in Hawaii on the world's largest telescope capable of operating at wavelengths shorter than 1mm. Due to be completed in 1986, the telescope will help explain the formation of new stars, the nature of quasars and the evolution of galaxies. "Chemists", say the Science and Education Research Council, "will have the opportunity to study complex molecules in space which may provide the key to life itself."

SERC, who are building the telescope in conjunction with the Netherlands Organization for the Advancement of Pure Science, says requirements are pushing microwave technology beyond the limits of current applications. Detectors using ele-

ments as small as 1µm² and cooled to a few degrees above absolute zero have been developed to solve a main problem of viewing at submillimetre wavelengths — that of the receiver sensitivity. Engineering and installation of the telescope is being carried out at SERC's Rutherford Appleton Laboratory by a team working in collaboration with universities and observatories in the UK and Netherlands including the Mullard Radio Astronomy Observatory at Cambridge University and the council's Royal Observatory in Edinburgh.

Tolerance of the 15m-diameter paraboloid form will be within 50µm — including distortions due to gravity when the antenna is turned.

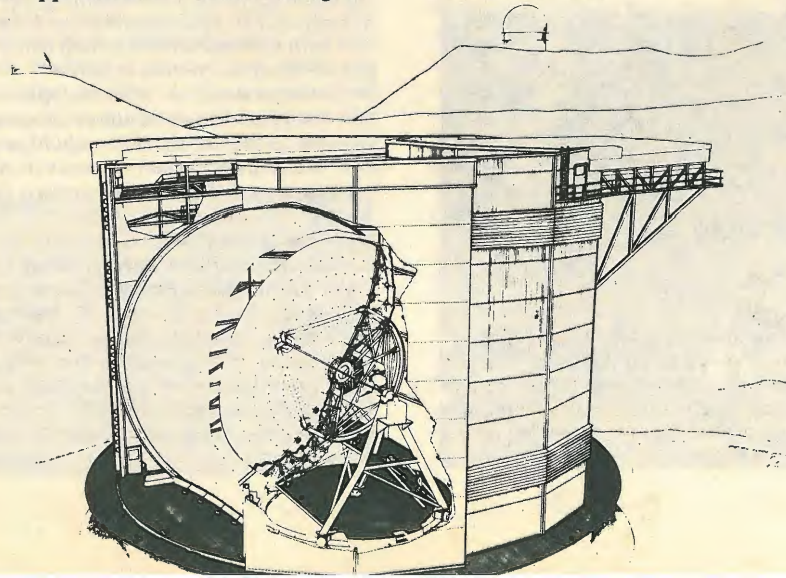

Ariane launches new satellites

A much needed boost for Europe's satellite-launching project came on 16 June with the near perfect launch of Ariane L6 in Guiana. Had the rocket failed — representing the third failure of six attempts — orders said to be worth about £300m could have been lost and the future of Europe's independent means of launching satellites put into serious doubt. Ariane's payload consisted of Europe's first communications satellite ECS-1 and the German Amst Phase 3B

ECS is a continuation of the OTS formula to provide trunk telecommunication between countries belonging to CEPT (European conference of posts and telecommunications), especially telephony and data transmission. Its other purpose is to provide colour television relays with sound and multiple commentary channels. Designed for a lifetime of seven years, ECS has a payload that includes twelve 20W, 11-to-14GHz repeaters and six antennae.

The other satellite launched from Ariane L6 is the Amst III-B, called Oscar 10 when fully operational. This satellite for amateur radio is designed to serve as an educational aid — to establish back-up communications networks over long periods covering most of the Earth using simple and inexpensive components, to study multi-user transponders and frequency-division multiple-access, to assess

the effectiveness of a highly eccentric orbit, and to demonstrate the practicability of using an onboard microcomputer for managing and monitoring the satellite's operation.

The telecommunications module consists of four main transponders, the first one (L1) with an uplink frequency of 435.175MHz downlink of 145.828MHz; Transponder L2, uplink 435.165MHz downlink 145.838MHz; Transponder H1 uplink 435.025MHz, and downlink 145.978MHz; Transponder H2 uplink 435.030MHz, downlink 145.973MHz. There is also an Amst net and calling frequency with an uplink of 435.040MHz and a downlink of 145.936MHz. The general beacon is transmitted at 145.810MHz and an engineering beacon at 145.987. At the time of writing the satellite has yet to be fully oriented toward the sun — battery charging is low and so the beacons are only being activated for short periods. The satellite has an expected life of three years.

Ariane L7, 8 and 9 launchers have been assigned to Intelsat V satellites F7, F8 and F9 and are scheduled for launch on 26 August, 4 November 1983 and January 1984 respectively.

Satellite news trial

To give "a valuable early indication of benefits from using satellites on a commercial scale in the future", BT are to carry out a three month trial distributing news and information by satellite starting in July. In the trial, Europe's first, Exchange Telegraph Co (Extel) will send speech and data from BT's Fleet building in London to its nine regional offices in the UK via European test satellite OTS. Working experience of locating and using small satellite aerials for businesses in urban areas will also be gained from the trial. Receive-only dish antennas of one or 1.8m diameter will be used at the regional offices.

Microphone on a chip

Using its recently developed zinc-oxide thin-film deposition technique, Honeywell has produced a microphone with microelectronics on a single silicon substrate, which is said to give better performance, sensitivity and reliability than current ceramic microphones at a fraction of the cost. Compared with ceramic devices which lose sensitivity at around 20Hz, the integrated zinc-oxide device operates at frequencies down to 0.1Hz. Honeywell say their 6.5 by 6.5mm 'mike-on-a-chip' can detect 1µbar, at which pressure the signal-to-noise ratio is 5:1, and that it is smaller and lighter than its ceramic counterpart measuring typically 6.5 by 12.5mm excluding electronics and leads.

Zinc-oxide thin-film techniques used produce a substance with characteristics

similar to those of piezoelectric crystals but compatible with standard i.c. fabrication processes. Like piezoelectric ceramic materials, zinc-oxide produces thermally-induced voltage fluctuations but the manufacturer claims to have eliminated this effect by using concentric electrodes. Existing semiconductor processes and equipment are used to fabricate the sensors which presumably accounts for their low cost.

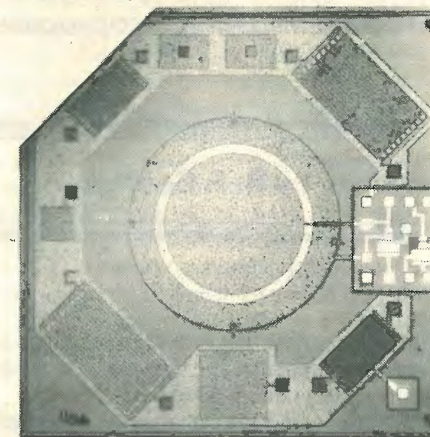

Data-base for telecomms

Abstracts and references to articles from more than 250 international periodicals, congress proceedings and reports are contained in a data base for the telecommunications industry recently brought on line by a Dutch company, Samsom Data Systemen bv. Including some 100 000 bibliographic references dating from 1976, the data base also contains information on 250 000 products, 7000 systems and 18 000 companies. The service is conveyed through the Euronet, Tymnet, Telenet, Teleglobe, Datapak and normal telephone channels. Search languages used are Common-Command Language, CCL, which was developed for the Commission of European Communities, and the IBM-related Storage Information Retrieval System known as Stairs.



In June, Russian satellite monitors received mayday signals from a radio distress beacon and an air/sea search was carried out. The beacon was later found in the wardrobe of a man living in Erskine near Glasgow.

Two new data banks covering electronic satellite equipment produced in Europe, Sateldata, and information on spacecraft components, Spacecomps, have been opened by European Space Agency Information Retrieval Service. These banks are produced by ESA Research and Technology Centre in the Netherlands and by ESA-IRS. Computers holding the information are based in Italy and linked to all major national/international data transmission networks and ESANET.

In brief . . .

During June, the Radio Regulatory Department was transferred from the Home Office to the Department of Trade and Industry but the Broadcasting Department and Directorate of Telecommunications stay with the Home Office. The Radio Regulatory Department is responsible for band planning and general policy on the use of the UK radio spectrum, civil radio licensing, representation of the UK in international frequency negotiations and liaison with foreign administrations. RRD also has general responsibility for the Wireless Telegraphy Acts, including their enforcement, and control of interference.

Corrections

Precision analogue voltmeter in W. J. Hornsby's design, June 1983, the junction of D₇ and D₈ should be linked to R₁₇, R₁₈ and IC₃ by a 0.47µF capacitor (C₇) and not by a direct connection as shown in Fig. 1. Also omitted from Fig. 1 was a 68µF capacitor (C₁₀) across the positive supply. Both components are shown correctly on the printed circuit layout. In the resistance measuring unit (July issue), R₂₁ (180Ω) should be a fixed-value resistor.

Autoranging frequency meter. In the article by F. P. Caracausi on page 36 (March issue), or second line of the centre column, for MCP read MST. On page 37, line 13 should read "from the timing module" not the counting module. Line 4 under the subheading "Timing," MCE goes low, not high. Line eight under "timing," MCE also goes low if . . . In the caption under Dr Caracausi's picture, he works at the Cassa Centrale di Risparmio and not as printed. In Fig. 1, the pin marked 17 on the display should be 7. Fig. 2, the pin marked 5 on the IC₁₂ should be 15, and finally in Fig. 6, the inputs marked DP on the counting module should have the same designation as the inputs from the scaling circuit to which they are connected.

Mixed logic. M. B. Butler tells us he made two errors in his July article (page 28 et seq.) — in Fig. 18 the flag or polarity indicator was missed off the 7427 gate, and also off the first output marked A in Fig. 27. But to come clean we also made a few. In Fig. 8, negate the C symbols in both output functions; and Fig. 9 refers to the third point in the summary, not the fourth (delete 'below'). In Fig. 15 case (vi), transpose the A and B columns, and in Fig. 16 make the bottom output of the voltage table H, not L. Insert the symbol 1 in the lower three alternative rectangles of Fig. 17, and finally note that IC₃₁ in Fig. 28 is an or-gate, not a nand-gate.

Assembly language programming

To avoid extra processing time, microprocessors manipulate negative numbers in twos complement signed binary form. In this fifth article, converting such numbers, branching and bit manipulation conclude the section on microprocessor instructions for the 6805.

by R. F. Coates

In twos complement conversion, positive numbers are represented as before but negative numbers are a ones complement with one added. For minus five,

+5	0000 0101
ones complement	1111 1010
twos complement	1111 1011

Adding plus eight and minus five becomes

+8	0000 1000
-5	1111 1011
binary sum	(1) 0000 0011

and the binary sum of plus three is now correct.

The branch instruction expects to find a twos complement value in the immediate byte which it adds to the program counter and execution proceeds from the new address. When assembling, the assembler (or you if you are programming by hand) must calculate this value and insert it in the object code. Assembled, and with the addresses filled in, the example discussed last month,

```
LDA #505
LOOP DECA
BNE LOOP
SWI
```

becomes

```
030 A605 LDA #505
032 4A LOOP DECA
033 26xx BNE LOOP
035 83 SWI
```

where xx is the twos complement offset. One calculates the offset by subtracting the branch address of the instruction following the branch (035) from the branch destination address (032)

\$032	0011 0010
\$035	(1) 0011 0101
result	1111 1101

In hexadecimal, the result is FD; (1) is an imaginary borrowed number. During execution, the two bytes of the branch instruction enter the c.p.u. from program memory and the program counter is incremented. The program counter will now contain 35 (hex.). If the branch condition is met, the program counter and offset byte are added together

\$035	000 0011 0101
\$FD	(111) 1111 1101
result \$032	(1) 000 0011 0010

As the offset has fewer bits than the program counter, the sign bit is extended into the remaining three bits.

Twos complements may seem complicated but they make the most efficient use of the microprocessor and result in fast execution. Computer assemblers calculate the offset automatically and there are easier ways of determining the offset when working by hand. Using the previous example count in hexadecimal past each byte of the op-code starting from the address of the instruction following the branch until the destination address is reached. When going backwards count 00 is followed by FF then FE, etc, as in the example

Offset	Op-code	
\$00	83	
\$FF	xx	
\$FE	26	
\$FD	4A	(destination address)

This method is quick in practice but it is easy to make mistakes with long branches. To solve this problem, a branch calculator program is included in the Picotutor (and Nanocomp) monitor. With Picotutor*, press the bc key and S will be displayed to request a three-digit starting address for the branch. This is the address of the branch instruction and not the instruction following it. When 033 from the example is entered d is displayed, indicating a request for the destination address, 032, and entering this will display the twos complement offset required, FD.

A branch can only go forward 127byte or back 128 - if you try to branch further the error message will be displayed. Should you wish to branch conditionally, further than this, there are two means. One way is to use a second, or more,

*Picotutor is an assembly-language programming aid described in *Wireless World* Dec. 1982 and Jan. 1983.

branch instruction to hop to the desired location

```
BEQ LABEL1
```

```
LABEL1 BRA LABEL2
```

LABEL2

A second method is to use a combination of the complement of the branch instruction required and a jump. Extended jumps will allow the program to jump anywhere in memory

```
BNE BYPASS
JMP LABEL
BYPASS (next instruction)
```

LABEL

When the branch-not-equal-to-zero (BNE) condition is true, the program branches past the jump and executes the next instruction, in effect just continuing the sequence. If the condition is not met, JMP is executed and the program can jump anywhere in the memory. Combining BNE and JMP amounts to a jump-if-equal-to-zero instruction.

To summarize, when assembling by hand leave blanks in the object code where a branch offset is required, assemble the program and fill in the addresses then use the branch calculator program to help fill in the offsets.

Branch instruction range. There are 17 branch instruction for the 6805, excluding bit-test-and-branch described in the next section. They all require two bytes, the op-code and the eight-bit offset. None of them affect the condition-code register; only one addressing mode applies, which is relative.

Branch always, BRA, is an unconditional branch, that is, a branch will always occur when this instruction is encountered

Branch never, BRN, a branch instruction which never causes a branch, has the dubious function of performing a two-byte no-operation which takes the same time as two NOP instructions. Its only value is with the cmos 6805 where it only requires

three cycles to execute so timing delays can be set to a resolution of one cycle instead of two.

Branch to subroutine, BSR, unconditionally branches to a subroutine and is the same as BRA except that the return address is stored on the stack.

Branch if lower or same, BLS, causes a branch when either C or Z bits in the condition-code register are set. If a comparison (subtraction) is performed prior to this instruction and the numbers are the same, the Z bit will be set. When the number in the accumulator or index register is less than the number being subtracted from it, a borrow value occurs and the C bit is set, i.e.

```
CPX #12
BLS LABEL
```

will cause a branch if the index register contains 12 or less.

Branch if higher, BHI, is the complement of BLS, causing a branch if both C and Z bits are clear,

Branch if interrupt pin low, BIL, allows the interrupt input to be used as an extra input line if the interrupt mask is set, when the instruction causes a branch if the interrupt signal is logical 0.

Branch if interrupt pin high, BIH, causes a branch if the signal at the interrupt input is logical 1.

Remaining branch instructions cause a branch depending on the condition of just one of the condition-code register bits. The half-carry bit is set as a result of a carry from bit three to bit four in the accumulator with instructions ADD or ADC, and is used in decimal arithmetic described later.

BCC Branch if carry clear, which may also be referred to as branch if higher or same, BHS.

BCS Branch if carry set, which may also be referred to as branch if lower, BLO.

BNE Branch if not equal to zero, i.e. when the Z bit is clear.

BEQ Branch if equal to zero, i.e. when the Z bit is set.

BHCC Branch if half carry clear.

BHCS Branch if half carry set.

BPL Branch if plus, i.e. if N bit is clear.

BMI Branch if minus, i.e. if N bit is set.

BMC Branch if interrupt mask, bit I, is clear.

BMS Branch if interrupt mask is set.

Bit manipulation

The final section of the instruction set covers bit-manipulation instructions for the 6805. Although the Z80 has similar instructions, 6800, 6802 and 6809 type microprocessors do not. Bit-manipulation instructions fall into two categories - bit set/clear and bit-test and branch. They are intended for manipulating i/o port data for setting or clearing a single output port line which may for instance drive a relay, or for

testing the status of an input line which may be connected to say a switch causing a branch depending on its state. As these instructions are intended for i/o control only direct addressing is allowed, which means that they can only be used to operate on addresses in the range 00 to FF.

Bit set/clear. Any bit in any byte in address locations between 00 and FF may be set to a one or cleared to zero using these instructions. They are two-byte instructions consisting of the op-code and a direct address and their mnemonics are BSET and BCLR. Two arguments are required in the operand field, the number of the bit to be operated on, between zero and seven, and the direct address of the byte which contains the bit. BSET 3,\$32 will cause bit 3 of address location 32 to be set.

When assembling, the bit number modifies the bit-set instruction op-code and 32 goes into the second byte of the instruction. From the instruction-set table (WW April 1983, page 64) the op-code is calculated using 10+2n where n is the bit number (working in hexadecimal). For bit three, n is three which gives 10+6 so the assembled version of the above instruction is

```
1632 BSET 3,$32
and it can be tried out using this example
040 3F32 CLR $32
042 1632 BSET 3,$32
044 83 SWI
```

When the program finishes, check the contents of address location 32 using the memory-open key (mo); it should hold eight because the address was cleared before bit three was set.

```
bit number      7 6 5 4 3 2 1 0
contents of location 32 0 0 0 0 1 0 0 0
```

Bit test and branch. Instructions BRCLR and BRSET cause a branch when the specified bit in a byte in address range 00 to FF is clear or set respectively. These are three byte instructions. The first two bytes are the op-code modified by the bit number and the direct address of the byte, as with bit set/clear. Byte three holds the twos complement branch offset. Three arguments are required in the operand field, the bit number, the direct address and the branch label/address, e.g.

```
040 0E00FD LOOP BRSET 7,$00,LOOP
043 203B BRA $80
```

Op-codes for bit-manipulation instructions

Op-code	Mnemonic	Op-code	Mnemonic
00	BRSET 0	10	BSET 0
01	BRCLR 0	11	BCLR 0
02	BRSET 1	12	BSET 1
03	BRCLR 1	13	BCLR 1
04	BRSET 2	14	BSET 2
05	BRCLR 2	15	BCLR 2
06	BRSET 3	16	BSET 3
07	BRCLR 3	17	BCLR 3
08	BRSET 4	18	BSET 4
09	BRCLR 4	19	BCLR 4
0A	BRSET 5	1A	BSET 5
0B	BRCLR 5	1B	BCLR 5
0C	BRSET 6	1C	BSET 6
0D	BRCLR 6	1D	BCLR 6
0E	BRSET 7	1E	BSET 7
0F	BRCLR 7	1F	BCLR 7

The op-code for BRSET is 2n and in this case n is seven which gives a hexadecimal result of 0E. Provided that bit seven of address 00 is set to one, this program branches to the label loop, i.e. back to the start of the same instruction, and repeatedly executes the same instruction until the branch condition is not met.

Address 00 is the eight-bit i/o port on the 68705. In Picotutor, this port is connected to the eight-way dual-in-line switch with bit seven connected to the left-most switch. At switch on this port is automatically set as eight input lines and if the switch for bit seven is open a pull-up resistor in the processor makes this bit appear as a 1 (set) when address 00 is read. When the switch is closed, the associated processor input pin is connected to 0V so bit seven appears as a 0 (clear) when address 00 is read.

If the program is run with the switch open, the branch-if-bit-set instruction is repeatedly executed and the display blanks as the monitor program is no longer operating it. With the switch closed the branch-if-bit-set condition is no longer true as bit seven is clear so the loop is broken and the next instruction executed. This also causes a branch, but to the monitor re-entry point so the Picotutor dash prompt is displayed.

Branch offsets may be calculated on the Picotutor even though the function was designed for two-byte numbers and not three. For three-byte bit-test-and-branch instructions the result from the calculator must be decremented by one, as in the following key sequence

Key	Display
bc	S
040	d
040	FE

where the offset minus one is FD. Having to calculate op-codes for bit manipulation instructions can be tiresome; the table lists all combinations of these instructions and equivalent op-codes.

Programming techniques are the subject of the next article.

In brief . . .

Paisley College are to receive a £63,000 grant from the Science and Engineering Research Council for research into ferrite-loaded microwave i.c.s operating at frequencies between 20 and 100GHz. Several i.c.s have already been built by research student David Sillers who will "spend some time at Philips and BT research laboratories, who are both collaborating in this work."

Four carrots for the Berlin International Audio and Video Fair 1983, 2 to 11 September - the world's smallest studio-quality u.h.f. pocket transmitter from Senheiser, a professional mobile video recorder from Grundig for teaching, research work, information services and advertising, Hitachi's VHS recorder giving 8h of uninterrupted film from a standard 4h tape and Sony's Beta camera/recorder weighing 2.5kg and giving three recording hours from a standard cassette.

Two-metre transceiver

Besides helping one understand operation of the transceiver, this description of software — which completes the multi-mode transceiver design — will aid software modification.

Transceiver software consists of a main control program which calls various subroutines in sequence, as shown in flow-chart form in the March issue, page 39. Conveniently, this technique allows certain routines to be bypassed by simply removing reference to them from the control program. Removing a subroutine during program development was simply a matter of taking out three or four bytes in the main control program, which is useful if one is not sure where a program error lies.

Repeater subroutine. When the main program calls repeater mode, the repeater subroutine sets the peripheral interface adapter A-port for data input and sets the controls-enable signal, pin 36 of IC₈₀₄, to

by T. Forrester, G8GIW

one. Machine code for setting the p.i.a. A-port for input and activating controls-enable is located between addresses 188B and 1995. This code, used each time controls are tested, stores the status of the controls in the accumulator. If bit zero is clear, repeater mode is bypassed but if bit zero is set the processor tests for receive by looking at bit one of the p.i.a. A-port. A 'one' on this line tells the program that the transmitter is to receive and that no shift is required so repeater mode is left.

Bit zero being at 'one' indicates that transmitting and a negative 600kHz shift (JSR NVE) are required. On return from the negative-shift subroutine, JSR NVE, the program loops, testing bit one of the A-port until a 'one' is detected to indicate that receiving is required. At this point the program jumps to the positive-shifting subroutine, JSR PVE, adds 600kHz then leaves the repeater subroutine.

Software detects whether the transceiver is set for transmit or receive by addressing IC₈₀₃ (see March issue, page 41) which passes the status of press-to-talk, up-frequency, down-frequency, squelch-open and power-on controls. Machine code between locations 1880 and 188A enables IC₈₀₃ through pin 33 of the processor and loads the buffered switch signals into the accumulator. This code is used every time the status of up/down, transmit/receive squelch and power-on controls is required. Repeater routine is between memory location 1831 and 1844.

Reverse repeater subroutine. This subroutine is more complex than the previous one because the receiver is operating at 600kHz below its original frequency in repeater mode, so when reverse repeater mode is entered the frequency has to be restored to its original value. While receiving in reverse repeater mode, the subroutine has to call all the routines normally needed for simplex mode, including tuning up/down, scan and erase, to allow the band to be tuned.

On entering the reverse repeater routine, software tests for transmit or receive. If receive is detected, the program jumps to the negative-shift subroutine, JSR NVE, used in repeater mode to subtract 600kHz. Detection of a transmit condition causes the program to jump to the simplex routine, JSR SIMP, and loop so long as the transmit condition exists; this disables the rest of the controls. Simplex routine is

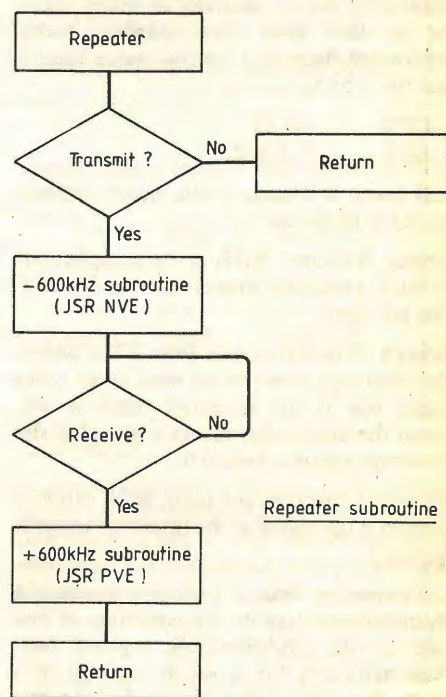

Repeater subroutine

located between 1879 and 187F and uses the subroutine between 1880 and 188A to test the p.t.t. line. When the transceiver is set up to receive and has just shifted - 600kHz, another loop is entered to test for receive and reverse repeater mode (see flow chart).

Scan subroutine. On entering this subroutine from the main program, the first operation tests to see if scan has been selected and if not, returns to the main programme. When scan mode is selected the software looks at the squelch status signal entering pin 6 of IC₈₀₃; squelch open, i.e. signal present, is represented by a one on the line. If a signal is present the test routine is carried out to see whether the next frequency to be monitored is to be skipped over or not. If the frequency is to be skipped, the synthesizer is moved to the next channel and control is passed back to the scan routine.

Now the program again checks for the presence of a signal and if it is still there, 12 is loaded into the accumulator and then stored in the first temporary location (TEMP1) at address 002F. The value 12 loaded into temporary location one determines how long the transceiver monitors each channel, and is gradually decremented. Delay value 12, currently held in location 195B may be changed to increase or decrease the delay as desired.

Pressing the skip button while monitoring a frequency in scan mode results in the

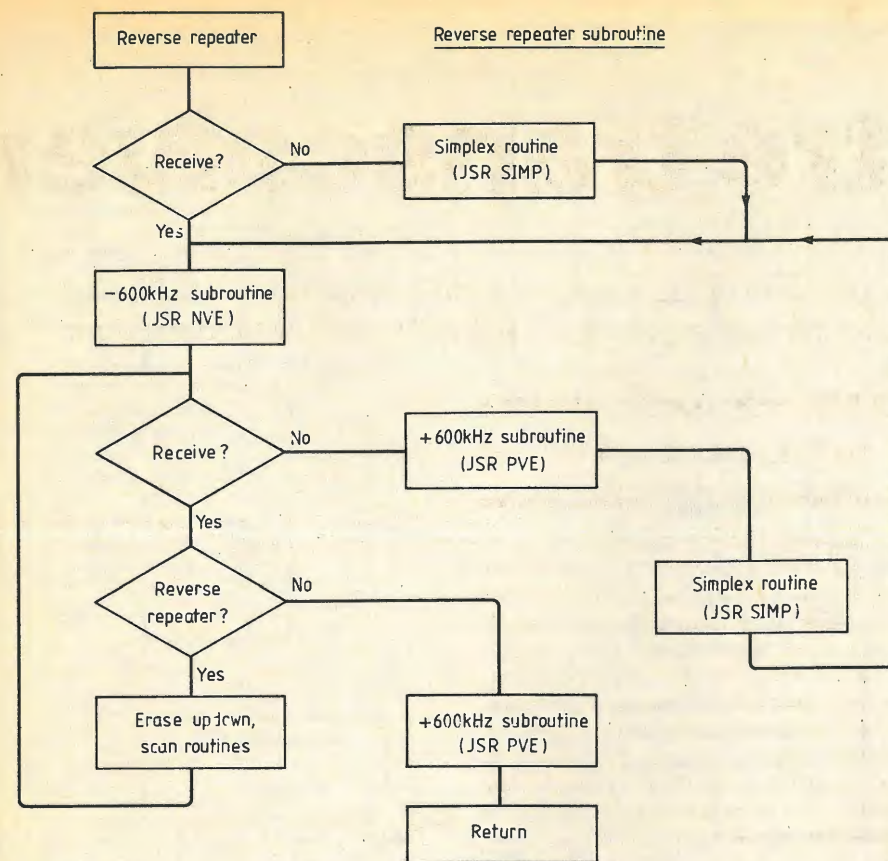

Reverse repeater subroutine

Simplex subroutine

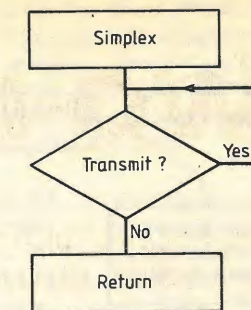

repeater and skip modes which do not operate in the memory mode. Memory subroutine is best dealt with by breaking it down into units each providing a function.

Unit one is a memory scan, which takes frequency data from memory-frequency ram locations between 1D and 32 in sequence. Two bytes are used for each frequency — one byte controls the 100Hz steps while the other controls the voltage-

frequency being included in the skip look-up table by means of the frequency-add subroutine, FADD. Next time the synthesizer stops at this frequency the test subroutine will cause it to be bypassed. Not pressing the skip button while monitoring a frequency causes the program to jump to a delay loop (JSR WT2) after temporary location TEMP1 is decremented. Delay loop WT2, located between 1913 and 1936, decrements ram location 0015 from 00FF to zero and is carried out 15 times.

While in the WT2 loop, the program monitors the power line and on detection of the set being switched off causes 8E to be loaded into ram location 0014: this operation puts the processor in its stop mode. After leaving the WT2 delay loop the program tests whether scan mode is still required and if so tests the temporary location at 002F for zero. When the TEMP1 test for zero is true, program jumps to the scan-up subroutine, JSR SCNU, located between 1980 and 19A2. Scan-up routine increments the synthesizer in scan mode and sets top and bottom frequency limits for scan mode. Location 1991 currently holds E4 to set the highest frequency of a scan to 145.9999MHz. An increase of one unit represents an increase in the top frequency of 10kHz. Similarly location 1995 holds 1C representing the lowest frequency of 144MHz.

With present hardware the maximum and minimum frequencies are 146.270 and 143.700MHz. To widen these limits, wiring of IC_{800,801} shown on page 39 of the March issue would have to be modified.

Memory subroutine. This subroutine is the most complex, encompassing all of the other subroutines except those for reverse

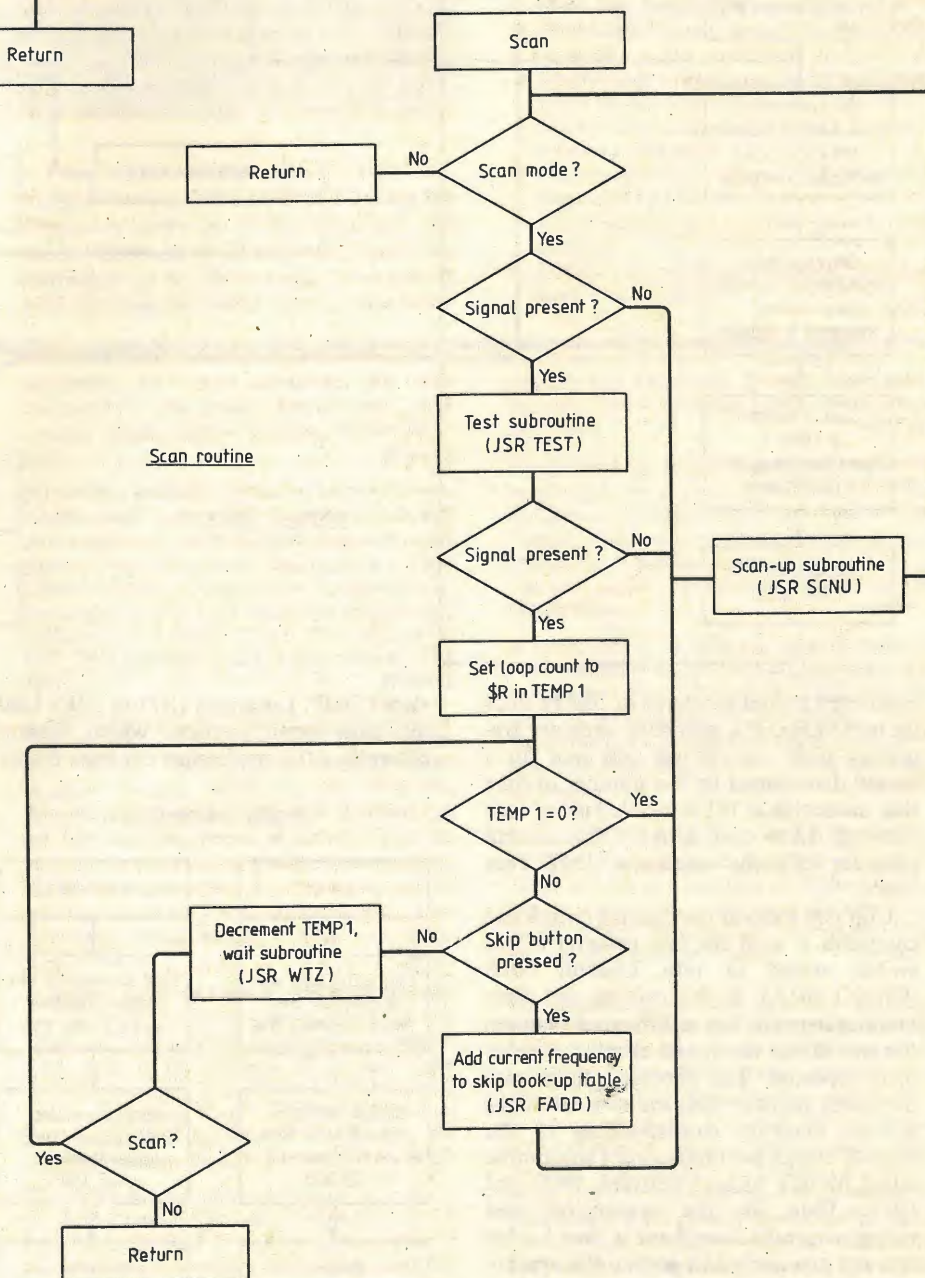

Scan routine

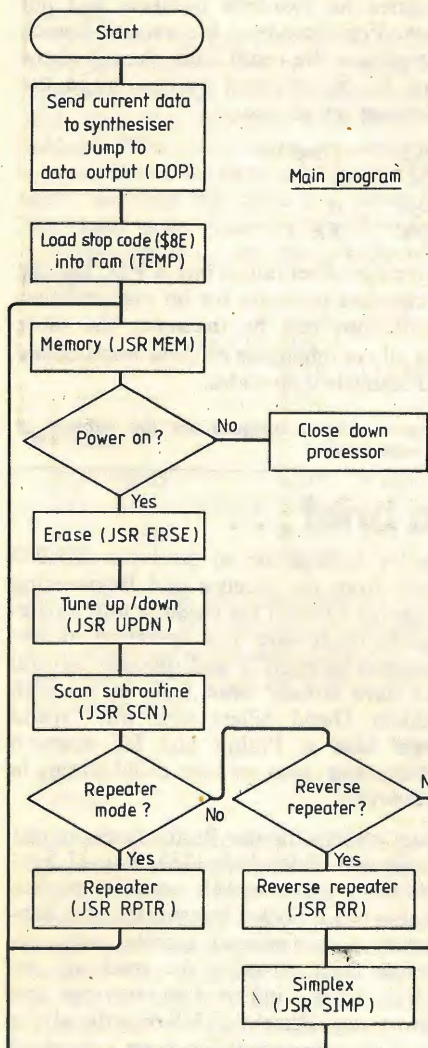

Main program

Eprom starts at 1800 hexadecimal and software breaks down into these main routines. Erase and up/down routines were covered in the April issue

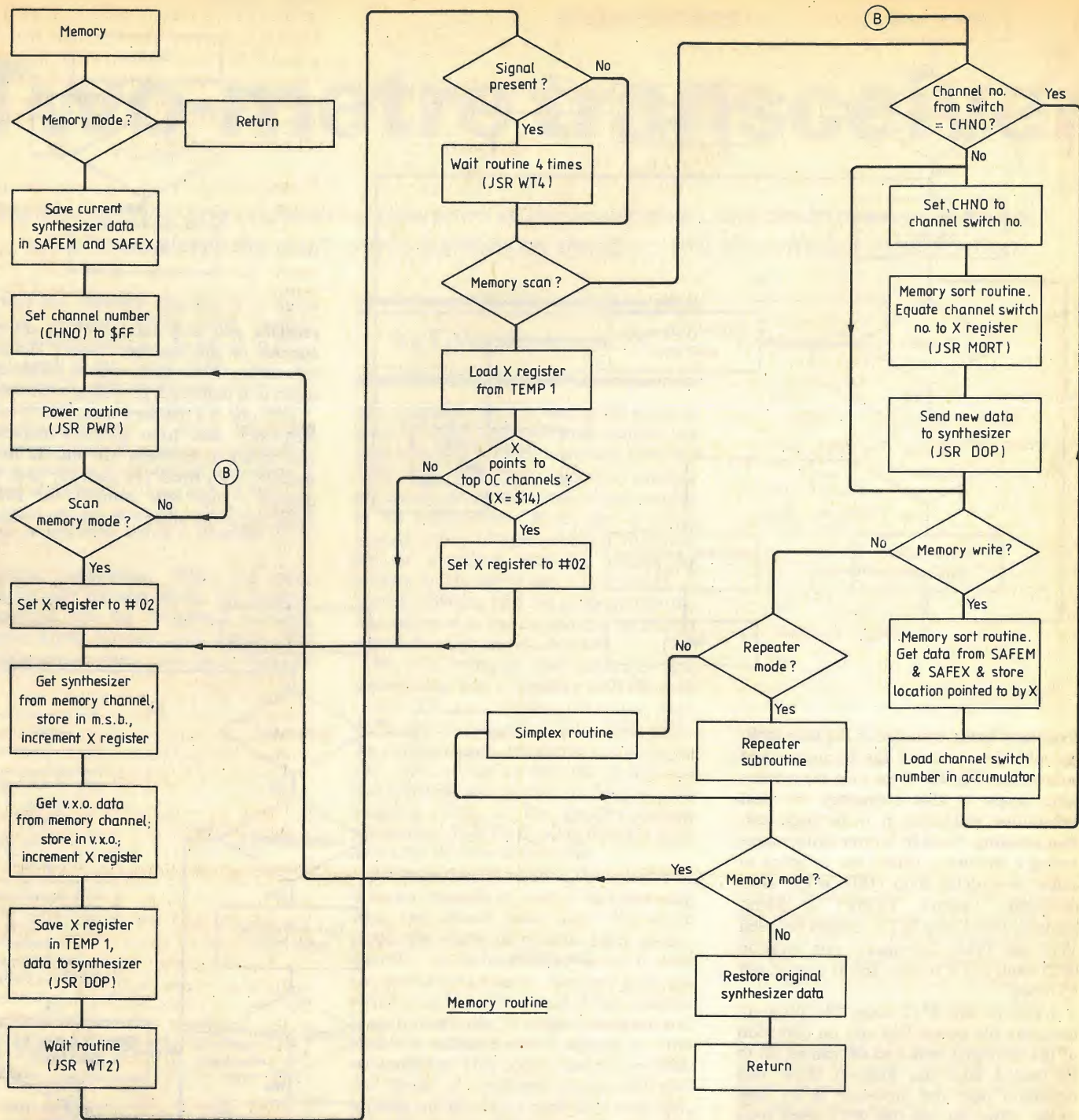

controlled crystal oscillator in 100Hz steps up to 9.9kHz. If a particular memory frequency is in use the set will wait for a period determined by the number of time that the routine at 191D is called using code between 1A94 and 1AA2. The current program calls the routine at 191D four times.

Unit two looks at the channel switch and compares it with the last position of the switch stored in ram location 001A (CHNO 001A). If the two are the same nothing happens but a difference between the two causes the stored channel number to be updated. The processor then loads the index register with the content of the memory location corresponding to the channel-switch position using a subroutine called MORT located between 1B07 and 1B16. Data for the synthesizer and voltage-controlled oscillator is then loaded into the processor and sent to the synthesizer using a data-output routine, abbrevi-

ated DOP. Locations 1B71 to 1BE2 hold the data-output routine, which besides controlling the synthesizer converts binary

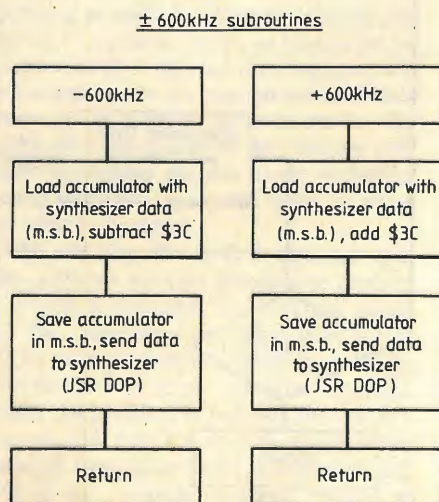

to condensed multiplexed b.c.d. to drive the display. Every time the frequency is changed in any mode, the data-output subroutine is used.

Unit three takes the frequency in use before memory mode was entered and places it in the memory locations pointed to by the channel switch then the program jumps back to unit two to send the data to the synthesizer. Unit four allows repeater mode to be used while in memory mode and provides the way out of memory mode, restoring the original operating frequency. When the program is in memory mode, the original operating frequency is stored in ram locations 0012 and 0013 for synthesizer and voltage-controlled oscillator data respectively.

±600kHz subroutines. Positive shift, PVE and negative-shift, NVE routines reside in locations 18AB to 18B5 and 18A1 to 18A7 respectively and add or subtract

Specification		
Frequency coverage	144 to 146MHz	Power
Frequency steps	100Hz or 25kHz	16.5W f.m. and 14.0W p.e.p. s.s.b. with 13.8V supply
Frequency display	7-digit l.e.d. with 100Hz resolution	Spurious outputs
Tuning method	up/down buttons on microphone or channel switch (select memory channel)	-70dB at 16.5W -45dB at 288MHz -50dB at 432MHz
Memory	9 memories programmed by push button - may be scanned with six second hold	Carrier suppression
Scanning	scan memory channels or scan band (144 to 146MHz) with provision to skip up to 40 channels	50dB (s.s.b.)
Modes	f.s.b., u.s.b., f.m. simplex, repeater and reverse repeater	Squelch threshold
		0.1µV (s.s.b. and f.m.)
		Bandwidths
		2.4kHz s.s.b. 12.5kHz f.m.
		Sensitivity
		0.26µV p.d. for 12dB quieting (f.m.) 0.13µV p.d. for 12dB s/n ratio (s.s.b.)
		Receiver image response
		-76dB
		Third-order intercept point (receiver)
		-1dBm
		Size
		205 by 250 by 65mm
		Antenna impedance
		50Ω nominal

600kHz from synthesizer data stored in 0010. Hexadecimal value 3C is the equivalent of 600kHz in this case. Both of these routines use the data-output routine, DOP, to modify the synthesizer and display.

Four lesser routines remain. The first, located between 18B6 and 18CD, takes the frequency down in 25kHz steps and the second between 18CE and 18E7 takes the frequency up in 25kHz steps. Two similar routines causing 100Hz steps up and down

LITERATURE RECEIVED

A comprehensive 64-page catalogue of radio-frequency interference filters for mains power and other uses has been published. It lists 120 filters from a plug-and-socket model to keep noise out of home computers or hi-fi to a 800A power filter or a 32-line filter for data transmission which can handle 9.6Kbit/s. Belling Lee Intech Ltd, 240 Great Cambridge Road, Enfield EN1 3QW. **WW407**

The first issue of the *Electronics for Peace Journal* reports on the first national conference of the Electronics for Peace movement and includes articles on the reliability of digitally-controlled weapons, the dangers of Ada, the computer language designed for use by the US Department of Defence, which could be error-prone. On the positive, and peaceful, side there is an article on information networks at the domestic level. Membership of *Electronics for Peace*, including a free subscription to the Journal, is £5 (£3 for the unwaged) to Steve Holmes, 151 Courthouse Road, Maidenhead, Berks SL6 6HY. **WW408**

Stepping motors and suitable drives and some useful design features explained in a four-page brochure. Evershed and Vignoles Ltd, Acton Lane, London W4 5HJ. **WW409**

Television and audio spare parts, especially for the Rank Bush/Murphy equipment forms the core of the Mastercare catalogue, which also has service aids and tools, instrument and test

equipment and various accessories and other components. Mastercare Components, 653 London Road, High Wycombe, Bucks HP11 1PH. **WW410**

Microwave products including ferrite devices, valves, noise generators, noise standards and power units are fully illustrated in a product guide. There are precise descriptions of five different types of waveguide circulators/isolators, together with information on transitions/isolators, and a design service. Nore Microwave Ltd, 36 Towerfield Road, Shoeburyness, SS3 9SH. **WW411**

Training schemes for schools, college and apprentice use are described fully in a booklet from Taran. Blackboard-sized breadboards illustrate circuits which can be built and demonstrated to a class or group. Students can get hands-on experience of circuits from the very simple to advanced studies in microwaves, digital electronics, control and automation, and communications. Taran International Ltd, Raynham Road, Bishop's Stortford, Herts CM23 5PG. **WW412**

A 'budget range' of toroidal transformers with dual secondary windings rated at 9 to 240V and single 110, 220 or 240V primaries, or a double 120V primary are available off-the-shelf from the manufacturers who have also published a leaflet describing them. Cotwold Electronics Ltd, Kingville Road, Kingsditch Trading Estate, Cheltenham, Glos GL51 9NX. **WW413**

The Bi-Pack semiconductor catalogue costs £1 (including postage) but does include some useful information such as pin-outs for a number of devices. Despite the title, there are a number of other components and tools, test gear, audio

are in locations 18E8 to 18FA and 18FB to 180D respectively. These routines may be modified to make the set operate with any channel spacing. Readers considering modifying the software will find the Motorola MC146805E2L microprocessor applications manual helpful.

Photocopies of p.c.b. track diagram and component positions can be obtained by sending a large s.a.e. to Wireless World Transceiver, Room L303, Quadrant House, The Quadrant, Sutton, Surrey SM2 5AS. Programmed eproms at £8 and software listing at £1.50 including UK postage and vat are available from T. Forrester, 125 Seven Way, Blechley, Bucks.

Modules

- 1 Receiver converter, 144MHz to 9MHz November 1982. pp.35-38
- 2 Transmit converter, 9MHz to 144MHz December 1982. pp.61-63
- 3 Transmit power amplifier and power regulators -December 1982 pp.61-63 January 1983 pp.42-45
- 4 Discriminator, squelch, noise blanker, a.f. power amp January 1983 pp.42-45
- 5 Synthesizer logic January/February 1983 pp.42-45
- 6 Synthesizer voltage-controlled oscillator, power change over February 1983 pp.38-41
- 7 9MHz s.s.b. transceiver, 9MHz f.m. exciter February 1983 pp.38-41
- 8 Microprocessor control and interfaces March 1983 pp.39-42
- 9 Frequency-display driver March 1983 pp.39-42
- 10 1750Hz tone-burst and receive a.f. pre-amp April 1983 pp.69-71 **WW**

modules and data books. Bi-Pack Semiconductors, PO Box 6,6A High Street, Ware, Herts SG12 9AG. **WW414**

The Zehntel p.c.b.-handling robot can identify boards and can position them at an automatic test station or a repair bench to within 0.5mm. Motion is six axes is claimed to be unique. Details in a brochure from Zehntel Ltd, 62 Tanners Drive, Blakelands, Milton Keynes MK14 5BP. **WW415**

A folder-full of 34 different sections make up the Verospeed catalogue which offers over 5,000 components from 120 manufacturers. New sections are cable accessories, data books, computer accessories and opto-electronics. Verospeed, Stanstead Road, Boyatt Wood, Eastleigh, Hants SO5 4ZY. **WW416**

Automated design and production facilities are available to designers of electronic equipment. These and the test facilities, all claimed to be at highly competitive prices, are described in a brochure from Tasbian Ltd, 2 Burrington Way, Plymouath, Devon PL5 3LS. **WW417**

The preliminary product brief for the Zilog Z800 family of microprocessor units specifies 8/16-bit devices with many added instructions including signed and unsigned multiplying and division, on-chip counter/timers, two versions also have on-chip u.a.r.t. and direct memory access channels. All versions include paged memory management to address 512Kbytes while two of them can cope with 16Mbytes. Also from Zilog is a user's manual for the Z800K floating-point emulation package. Zilog (UK) Ltd, 43 Moorbridge Road, Maidenhead, Berks SL6 8PL. **WW418**

NEW PRODUCTS

Audio oscillator with ultra-low distortion

Less than 0.0005% distortion is claimed for the Bang & Olufsen TG8 audio oscillator. Intended for circuit testing, test-gear calibration, and production-line product testing, its typical distortion is 0.00015% (harmonic) over the audio range 20Hz to 20kHz. The instrument is also a signal generator for 1Hz to 100kHz and has a wide range of facilities. Voltage output is from 3mV to 10V checked against a built-in voltmeter. David Bisset Ltd, 52 Luton Lane, Redbourne, Herts AL3 7PY. **WW301**



WW301

Autodial modem

Any computer that uses the S-100 bus can be fitted with the Modem-100 which provides a complete autodial viewdata modem and display driver on a single card. It gives full colour display output. The card includes an 8749 microprocessor, on-board ram and rom and a calendar clock which allows for timed autodialling. Modem-100 costs £695 but a cheaper (£495) alternative is Prattle (Programmable receive and transmit telephone line equipment) built around a Z80 processor, with rom and ram programs modem buffering, autodial and answering etc, using single byte commands. Prattle also interfaces with the S-100 bus. High Technology Electronics Ltd, 303 Portwood Road, Southampton SO2 1LD. **WW302**

Multi-counter

A dual-channel facility on the Norma D3655 counter enables frequency ratios and time intervals to be measured. The measuring periods of 10ms, 1ms, 1s and 10s allow frequency measurement up to 120MHz and event counting in the range 10Hz to 10MHz. A self-test facility checks on the internal

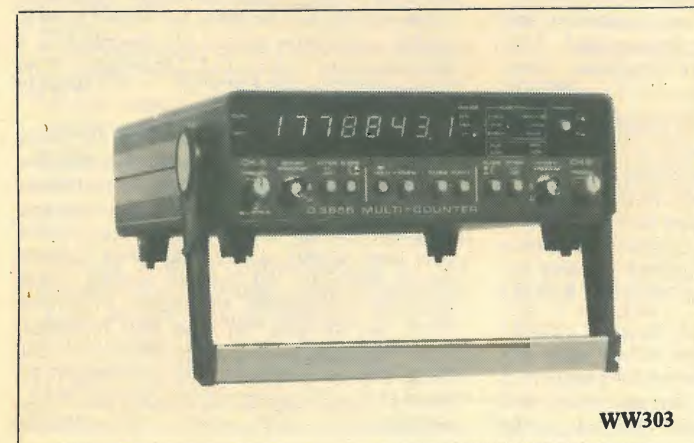

WW303

oscillator. D3655 is available with an IEEE 488 or an IEC 655 interface and so can be linked in with a data processing system. Cropico Ltd, Hampton Road, Croydon, Surrey CR9 2RU. **WW303**

Controlled soldering

A temperature range of 216 to 426°C may be regulated to within 5°C using a slim, lightweight, micro-tipped soldering iron along with the Ungar 9000 control unit that incorporates a led bar-graph temperature display and the ability to calibrate it at the work station. Model 9000 has a fast heat-up time and temperature recovery and the iron is supplied with a variety of interchangeable, iron-clad, chrome plated tips. HB Electronics Ltd, Lever Street, Bolton, Lancs. **WW304**



WW304

Speech synthesized to order

Inflexion, tone and clarity of synthetic speech can be easily adjusted when using the TI Portable Speech Lab, according to the distributors. Phrases for industrial control, alarm systems, measuring equipment, remote

monitoring, aids for the handicapped and childrens' games can be recorded and then edited to change pitch, emphasis or other parameters, and the edited version then programmed into an eeprom for use in a product. The package can also be used in an 'immediate' mode, being used as a peripheral processor to a host computer which can store the speech produced. Each stored phrase can be up to 10 seconds in length with sampling rates of 8 or 10kHz. The distributors are also offering a message programming service using the Speech Lab. VSI Microsystems, Roydonbury Industrial Park, Horsecroft Road, Harlow, Essex CM19 5BY. **WW305**

High-speed rectifiers

For use as output rectifiers and flywheel diodes in high frequency p.w.m. and switching regulator applications, the RUR series of low-cost epitaxial silicon rectifiers offer high reverse voltage capability. Several advantages are

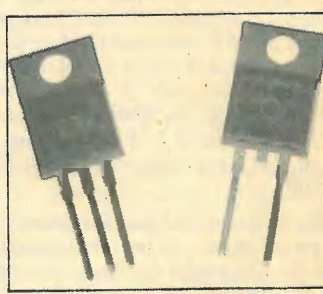

WW306

claimed for the diodes including low spikes, low electromagnetic interference requiring little or no RC damping, and low dissipation when compared with Schottky devices. The RUR-810 series are single rectifiers while the RUR-D810 are double i.cs with a common cathode. Rated for a forward current of 8A with a maximum forward voltage drop of 0.89V, the maximum reverse voltage is 200V. Voltage ratings vary for different diodes in the series from 100 to 200V r.m.s. Reverse recovery time is less than 35ns. VSI Electronics (UK) Ltd, Roydonbury Industrial Park,

Horsecroft Road, Harlow, Essex CM19 5BY. **WW306**

Very nice dear, but what's it for?

A company with a problem is Regisbrook of Reading who have samples of a very sensitive humidity sensor — so sensitive, they say, that it will detect the moisture in exhaled breath at a distance of 0.6m. It is battery powered and pocket sized with an adjustable mounting bracket. The sensing grid consists of interleaved gold filaments on a ceramic substrate. There is an integral alarm bleeper which is not triggered if the gold elements are shorted together. The alarm stops when the sensing grid is wiped dry.

The problem is: what can be done with it? A first prize of champagne, with ten runners up to get the sensor itself, for the best suggestions, serious or imaginative, which should be sent to Regisbrook Ltd, Studio House, 215 Kings Road, Reading, Berks RG1 4LS. **WW307**

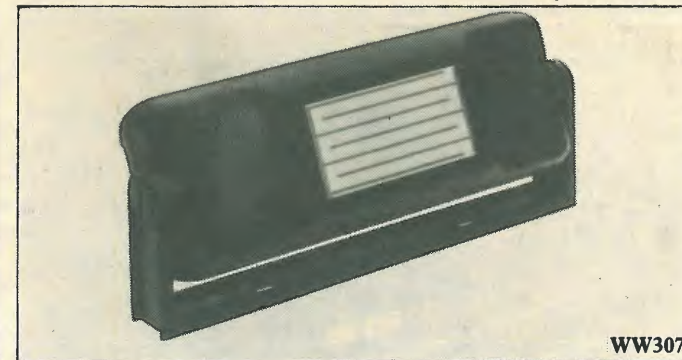

WW307

Infrared emitters

Two gallium-aluminium arsenide i.r. diodes emit radiant flux at a wavelength of 880nm. They are designed to have better coupling efficiency with silicon photodiodes and to be particularly suitable for use in pulsed applications. Output in pulsed operation is 100mW, and for continuous operation 10mW. The C86038E has a glass lens to produce a narrow beam, while the C86038E/F has a flat glass window and no lens. The devices may be used in high-speed sorting and counting, intrusion alarms, edge indicators, collision protection, optical coupling and isolation, data transmission and in photoelectric smoke detection. RCA Solid State, Lincoln Way, Windmill Road, Sunbury on Thames, Middlesex TW16 7HW. **WW308**

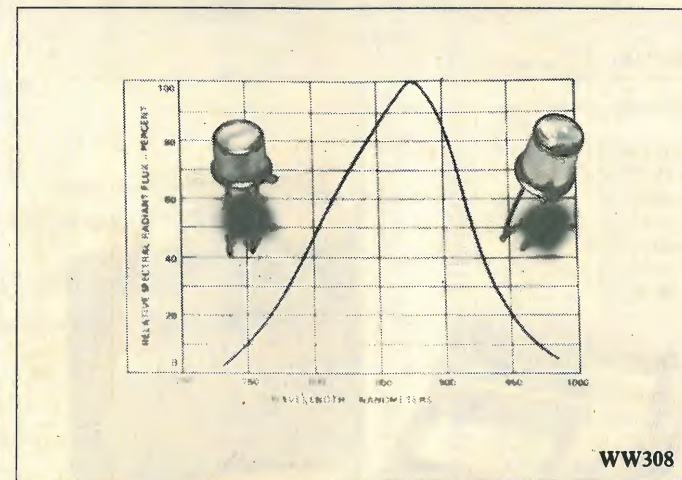

WW308

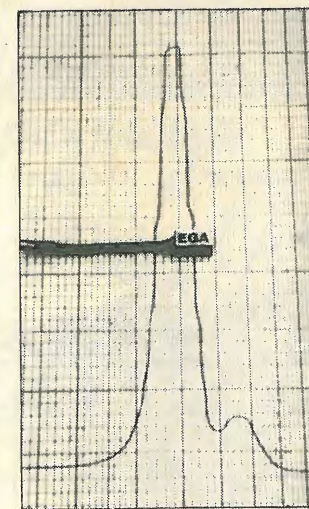

crash and barrier testing, rocket launching and monitoring, vibration testing and control, and basic laboratory experiments. Entran Ltd, 8 The Mall, London W5 2PJ. **WW309**

Accelerometer withstands 10000 g

A miniature transducer for the measurement of acceleration vibration and shock, the EGAX-125 weighs less than half a gram. The active semiconductor strain-gauge bridge gives a full scale output of 250mV. Built-in over-range stops and damping provide the ability to cope with high g. Static and dynamic measurement is available in various ranges from 5 to 5000 g, with a temperature range of -5 to 120°C. Its ability to operate at 10000 g overrange makes it suitable for automotive

Driver for stepper motors

Specifically designed to drive small to medium-sized permanent magnet stepper motors, the UCN4202A i.c. uses a full-step double pulse driver that optimizes the efficiency of the motor torque. Input/output circuitry is t.t.l.

compatible and a minimum of external components are needed, to provide 600mA outputs suitable for 15V motors. Higher current ratings or bipolar operation is possible by using the device to drive power transistors or other motor drivers. Semiconductor Specialists (UK) Ltd, 159 High Street, Yiewsley, West Drayton, Middlesex UB7 7XB. **WW310**

Switchmode kit

To demonstrate the capabilities of their m.o.s. power transistors and pulse-width modulators, Siliconix have brought out a 38-piece kit which assembles into a dc-to-dc converter able to output 5V, 10A from a 24V input. Operating at a frequency of 400kHz, the completed circuit is claimed to have better than 1% accuracy in regulation and less than 60mV output ripple. In addition to demonstrating the operation of such a circuit, the kit also shows its small size and low cost measuring 80 by 110mm and weighing 140g. £29.95 from Siliconix Ltd, Morriston, Swansea SA6 6NE. **WW311**

Game of logic

A board game that teaches Boolean algebra, digital logic, the Karugh map and Venn diagrams is based on a game invented by Lewis Carroll.

The beginners' pack, while said to be fun to play, teaches the elements of the workings of computers, hence the title of the game — Computer. Additional packs increase the number of 'memory bits' and variables up to a 'professional' level. Computer is made in cut-out cardboard. Beginners' pack is £1 from N. Darwood Ltd, Halfacre, Stroud, Petersfield, Hants. **WW312**

Connections verified

When a p.c.b. has been wire-wrapped there follows a tedious system of checking the interconnections to make sure that all is correct before populating the board with expensive i.cs. A way of overcoming this is to use

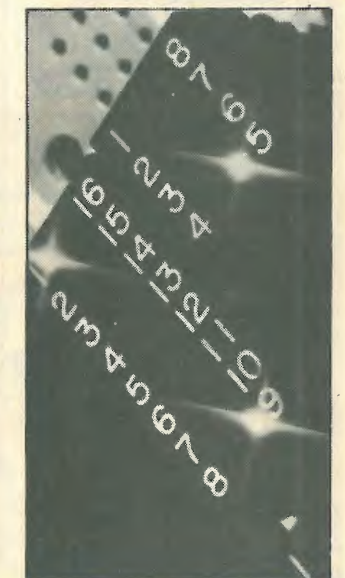

interconnect verifiers which are made in d.i.l. i.c. packages and incorporate arrays of l.e.ds with one to indicate the status of each pin, from eight to 48. By grounding one pin all the l.e.ds on one node are lit; incorrect connections will also be lit and points not connected, which should be, are not lit. Dim displays would indicate poor connections. This technique would not be suitable for mass production where a test rig would be set up, but offers a low-cost alternative for board development and for small batches. Track Equipment Corporation, PO Box 3181, Nashua, New Hampshire 03061, USA. **WW 313**

If you would like more information on any of the items featured here, enter the appropriate WW reference number(s) on the mauve reply-paid card bound in this issue. Overseas cards require a stamp.

BBC Micro Computer System

OFFICIAL DEALER

Please phone for availability

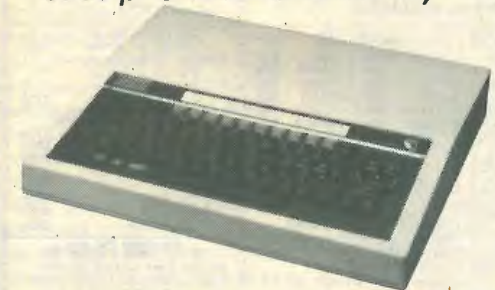

BBC Model B £399
(incl. VAT)
Carr £8/unit

Model A to Model B
upgrade kit **£50**

Fitting charge **£15**

Individual upgrades also available

TELETEXT ADAPTOR £195

WORDWISE 8K ROM £39

TORCH Z80 DISC PACK £780

WORD PROCESSOR 'VIEW'

16K ROM £52

BUSINESS, EDUCATION AND FUN SOFTWARE IN STOCK

CASSETTE RECORDER

SANYO Data Recorder DR101

A superior quality data recorder with dedicated computer output and monitoring facility on both record and play

£39.50 + £1.50 carr.

SLIMLINE Cassette Recorder complete with counter and remote control

£24.50 + £1.50 carr.

Computer Grade Cassettes

£0.50 each, £4.50 for 10 + £1 carr

Cassette lead **£3.50**

NEC PC 8023 BE - C

100CPS, 80 cols

Logic Seeking, Bi-directional,

Forward and Reverse

Line Feed,

Proportional Spacing,

Auto Underline,

Hi-Res and Block

Graphics, Greek Char. Set.

Only **£345 + £8 carr.**

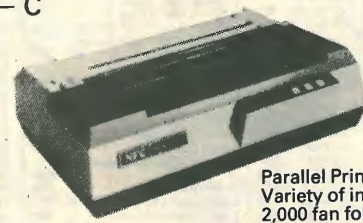

MONITORS

MICROVITEC 1431 14in Colour Monitor £249 + £8 carr

MICROVITEC 2031 20in Colour Monitor £319 + £8 carr

KAGA 12in RGB Monitor £255 + £8 carr

Lead for KAGA/SANYO RGB £10

SANYO HI RES GREEN MONITOR £99 + £6 carr

SANYO HI RES RGB MONITOR £445 + £8 carr

PRINTERS

SEIKOSHA GP 100A

80 cols 30 CPS

Full ASCII and Graphics

10" wide paper

Now only **£180 + £6 carr.**

GP250A £235 + £8 carr.

Parallel Printer lead for BBC/Atom to most printers **£13.50**

Variety of interfaces, ribbons in stock.

2,000 fan fold sheets 9 1/2" x 11" **£13.50 + £3 p&p**

FLOPPY DISC INTERFACE

incl. 1.2 Operating System

£95 & £20 installation

BBC FLOPPY DISC DRIVES

Single Drive 5 1/4" 100K **£230 + £6 carr.**

Double Drive 5 1/4" 800K **£699 + £8 carr.**

BBC COMPATIBLE 5 1/4" DISC DRIVES

These drives are supplied in BBC matching colour cases.

SINGLE DRIVES: 100K £150; 200K £215*; 400K £265

SINGLE DRIVES: with PSU 100K £185; 200K £260*; 400K £330

DUAL DRIVES: with PSU 200K £355; 400K £475*; 800K £595

*These drives are provided with a switch between 40 and 80 tracks.

DRIVE CABLES: SINGLE £8, DUAL £12.

DISC MANUAL & FORMATTING DISKETTE £17.50

Phone or send for our BBC leaflet

BBC BOOKS (no VAT; p&p £1)

Basic on BBC **£5.95**

30 House Basic **£5.95**

Programming the BBC Micro **£6.50**

BBC Micro An Expert Guide **£6.95**

Assy Lang Prog. for BBC **£8.95**

6502 Machine Codes for Beginners **£6.95**

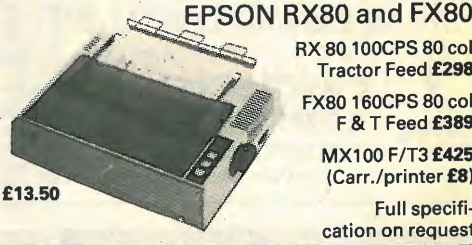

EPSON RX80 and FX80

RX 80 100CPS 80 col

Tractor Feed **£298**

FX80 160CPS 80 col

F & T Feed **£389**

MX100 F/T3 **£425**

(Carr./printer £8)

Full specification on request

CONNECTOR SYSTEMS

I.D. CONNECTORS

(Speedblock Type)

14-pin 16-pin 24-pin 40-pin

1 end 145p 125p 195p

2 ends 210p 230p 345p 540p

20-pin 26-pin 34-pin 40-pin

1 end 180p 200p 280p 300p

2 ends 230p 370p 480p 525p

D CONNECTORS

9 15 25 37

MALE Solder 80p 105p 160p 250p

Angled 150p 210p 250p 385p

FEMALE Solder 105p 160p 200p 335p

Angled 185p 215p 230p 440p

Hoods 90p 85p 90p 100p

IDC 25-way plug 385p. Socket 450p

TEXTOL ZIF

24-pin £5.75

40-pin £9.75

DIL SWITCHES

4-way 70p

6-way 85p

8-way 90p

10-way 140p

JUMPER LEADS

24" Ribbon Cable with Headers

1 end 145p 125p 195p

2 ends 210p 230p 345p 540p

24" Ribbon Cable with Sockets

1 end 180p 200p 280p 300p

2 ends 230p 370p 480p 525p

RS 232 JUMPERS

24" Single end Male..... £5.00

24" Single end Female..... £5.25

24" Female-Female..... £10.00

24" Male-Male..... £9.50

24" Male-Female..... £9.50

DIL HEADERS

14pin 40p

16pin 50p

24pin 100p

40pin 200p

AMPHENOL CONNECTORS

36-way plug Centronics Parallel

Solder **£5.25** IDC **£4.95**

36-way socket Centronics Parallel

Solder **£5.50** IDC **£5.20**

24-way plug IEEE Solder **£5**

IDC **£4.75**

24-way socket IEEE Solder **£5**

EURO CONNECTORS

DIN 41617 Plug Skt.

21-way 180p 185p

31-way 170p 170p

DIN 41612 2x32-way St. Pin 220p 275p

2x32-way Ang. Pin 275p 320p

3x32-way St. Pin 280p 300p

3x32-way Ang. Pin 375p 350p

TEST CLIPS

14-pin 275p

40-pin £8

EDGE CONNECTORS

0.1" 158p

0.15" 140p

0.2" 220p

0.25" 220p

0.3" 260p

0.35" 355p

0.5" 600p

5100 Conn 600p

RIBBON CABLE

(Grey/meter)

10-way 40p

16-way 60p

20-way 80p

25-way 120p

34-way 180p

40-way 180p

50-way 200p

64-way 280p

RUGBY ATOMIC CLOCK

This Z80 micro controlled clock/calendar receives coded time data from NPL Rugby. The clock never needs to be reset. The facilities include 8 independent alarms and for each alarm there is a choice of melody or alternatively these can be used for electrical switching. A separate timer allows recording of up to 240 lap times without interrupting the count. Expansion facilities provided.

See July/August '82 ETI for details.

Built and tested **£145 + £2 p&p.**

MICROTIMER

6502 Based Programmable clock timer with

★ 24 switching times/week cycle

★ 22-hour 7-day timer

★ 4 independent switch outputs directly interfacing to thyristor/triacs

★ 6 digit 7 seg. display to indicate real time, ON/OFF and Reset times

★ Output to drive day of week switch and status LEDs.

Full details on request. Price for kit **£57**

DISC DRIVES FOR THE FORTH COMPUTER

5 1/4" Teac FD55 Slim Line Mechanisms.

FD55A 40 track SSDD 250kbytes unformatted

Bare: **£135**; Cased: **£155**

2 x FD55A 40 track SSDD 500kbytes unformatted

Cased x psu **£350**

FD55E 80 track SSDD 500kbytes unformatted

Bare: **£180**; Cased: **£205**

2 x FD55E 80 track SSDD 1 Mbyte unformatted

Cased + psu **£475**

5 1/4" Mitsubishi M4853 Slim Line mechanism 80 track

DSDD 1 Mbyte unformatted Bare: **£225**; Cased: **£245**

2 x M4853 2 Mbytes Cased + psu **£590**

Single drive cable **£8**; Dual Drive cable **£12**

Other parts for FORTH COMPUTER available send SAE for details.

NEW COMPREHENSIVE CATALOGUE AVAILABLE PLEASE SEND FOR PRICE LIST

SOFTY II INTELLIGENT PROGRAMMER

The complete microprocessor development system for Engineers and Hobbyists. You can develop programs, debug, verify and commit to EPROMs or use in host computer by using softy as a romulator. Powerful editing facilities permit bytes, blocks of bytes changed, deleted or inserted and memory contents can be observed on ordinary TV. Accepts most +5V Eproms.

Softy II complete with PSU, TV Lead and Romulator lead **£169**

'WIRELESS WORLD' PROJECTS

Semiconductors inc. I.C.s., Transistors and Sockets for most projects are stocked by us

BOOKS

(No VAT p&p £1)

CRT Controller H/Book..... **£8.50**

Programming the Z80..... **£11.50**

Z80 Microcomp Handbook..... **£8.95**

Programming the 6502..... **£10.25**

6502 Assy. Lang..... **£12.10**

6502 Applications..... **£10.20**

6502 Software Design..... **£9.05**

6502 Games..... **£10.25**

Large selection of databooks, interfacing books, books on BBC, etc in stock. Ask for our list. WW-12

<p>74 SERIES</p> <p>7400 11p</p> <p>7401 11p</p> <p>7402 11p</p> <p>7403 12p</p> <p>7404 14p</p> <p>7405 15p</p> <p>7406 18p</p> <p>7407 18p</p> <p>7408 14p</p> <p>7409 14p</p> <p>7410 14p</p> <p>7411 16p</p> <p>7412 14p</p> <p>7413 16p</p> <p>7414 16p</p> <p>7415 16p</p> <p>7416 18p</p> <p>7417 18p</p> <p>7418 14p</p> <p>7419 14p</p> <p>7420 20p</p> <p>7421 20p</p> <p>7422 18p</p> <p>7423 18p</p> <p>7424 18p</p> <p>7425 18p</p> <p>7426 18p</p> <p>7427 18p</p> <p>7428 18p</p> <p>7429 14p</p> <p>7430 14p</p> <p>7431 18p</p> <p>7432 18p</p> <p>7433 22p</p> <p>7434 22p</p> <p>7435 22p</p> <p>7436 22p</p> <p>7437 22p</p> <p>7438 22p</p> <p>7439 25p</p> <p>7440 15p</p> <p>7441 55p</p> <p>7442 19p</p> <p>7443 70p</p> <p>7444 50p</p> <p>7445 50p</p> <p>7446 50p</p> <p>7447 50p</p> <p>7448 45p</p> <p>7449 50p</p> <p>7450 15p</p> <p>7451 15p</p> <p>7452 15p</p> <p>7453 15p</p> <p>7454 15p</p> <p>7455 15p</p> <p>7456 15p</p> <p>7457 15p</p> <p>7458 15p</p> <p>7459 15p</p> <p>7460 15p</p> <p>7461 30p</p> <p>7462 25p</p> <p>7463 25p</p> <p>7464 25p</p> <p>7465 22p</p> <p>7466 25p</p> <p>7467 48p</p> <p>7468 120p</p> <p>7469 85p</p> <p>7470 38p</p> <p>7471 38p</p> <p>7472 38p</p> <p>7473 38p</p> <p>7474 38p</p> <p>7475 38p</p> <p>7476 38p</p> <p>7477 38p</p> <p>7478 38p</p> <p>7479 38p</p> <p>7480 38p</p> <p>7481 38p</p> <p>7482 38p</p> <p>7483 38p</p> <p>7484 38p</p> <p>7485 60p</p> <p>7486 15p</p> <p>7487 180p</p> <p>7488 20p</p> <p>7489 35p</p> <p>7490 25p</p> <p>7491 35p</p> <p>7492 25p</p> <p>7493 35p</p> <p>7494 35p</p> <p>7495 35p</p> <p>7496 35p</p> <p>7497 90p</p> <p>7498 140p</p> <p>7499 140p</p> <p>7500 140p</p> <p>7501 140p</p> <p>7502 140p</p> <p>7503 140p</p> <p>7504 140p</p> <p>7505 140p</p> <p>7506 140p</p> <p>7507 140p</p> <p>7508 140p</p> <p>7509 140p</p> <p>7510 140p</p> <p>7511 140p</p> <p>7512 140p</p> <p>7513 140p</p> <p>7514 140p</p> <p>7515 140p</p> <p>7516</p>

Anglia Industrial Auctions

Specialist Auctioneers to the Radio and Electronic Industry

5 STATION ROAD, LITTLEPORT, CAMBS CB6 1QE
Telephone: ELY (0353) 860185

AUCTION SALES

OF OVER 700 LOTS

Including: Electronic and electrical equipment, components, test gear, radio telephones, laboratory equipment, valves, transistors, scrap and general works effects.

Forthcoming sales to be held on the following dates:

August 10th, 1983, September 14th, 1983
October 19th, 1983, November 23rd, 1983, January 11th, 1984
February 15th, 1984, March 21st, 1984, April 25th, 1984
May 30th, 1984, July 4th, 1984

Catalogues available 10 days prior to sale, price 60p inc. p.&p. or for each sale for a year £5 (10 sales)
Entry forms on application.

Large stocks of electronic components, test gear, radio telephones, transistors, etc. are offered for sale on tender. Please apply for forms

WW - 053 FOR FURTHER DETAILS

TEST EQUIPMENT

Marconi TF144H Signal Generator.....	£195
Solartron CD1740 50MHz Scope.....	£295
Tektronix 453A 60MHz Scope.....	£450
Tek.191 Constant Amp. Sig. Gen. 100MHz.....	£115
Tek. 184 Time Mark Generator.....	£125
Tek. 106 Fast Rise Pulse Generator.....	£95
Tek. 2901 Pulse Generator.....	£105
Tek. 067-0502 Standard Amp Calibrator.....	£95
Tek. 465B + DM44 DVM with handbooks, Temp. Probe and Accessory Pouch - as new.....	£1,800
Tequipment D83 50MHz Scope.....	£395
Racal 9514 100MHz Counter IEEE.....	£395
Tequipment D54 10MHz Dual Channel.....	£150
Avometers from.....	£50

Uncased 19in. B & W X-Y Monitors, require 30-0-30v. supply - new quantities available; made by Electrohome of Canada.....
£25

Ribbon Cable, 14-way, 100 metres.....
£25
10-way, 100 metres.....
£20

Carriage and V.A.T. extra

TIMEBASE

94 ALFRISTON GARDENS
SHOLING, SOUTHAMPTON SO2 8FU
TELEPHONE: 431323 (0703)



Callers welcome



Access/Barclaycard: Telephone your order

WW - 060 FOR FURTHER DETAILS

CLEF ELECTRONIC MUSIC

PIANOS

SPECIALISTS SINCE 1972
DOMESTIC OR STAGE
SIX OR 7 1/4 OCTAVES
KITS OR MANUFACTURED

The most advanced form of touch-sensitive action simulating piano key inertia by patented technique.

Four mixable voices for serious tone variation plus electronic chorus and flanger effects.

Component Kits include Keyboard.

Full Kits further contain: Cabinets, Harness, Power Amp and Speaker.

DOMESTIC PRICES		
E	SIX	7 1/4
Comp	234	266
Full	398	442
MFD	620	695

Kit £314
An Electronic Backing TRIC. Drums, Bass & Chord Instrument. User Programmable for 50-100 scores, using microprocessor.

Kit £499
VOCAL & INSTRUMENTAL SOLOISTS!

Kit £79
MASTER RHYTHM User Programmable DRUM MACHINE. Twenty-four patterns. Eight parallel tracks. Twelve instruments sequence operation.

Write or Phone for full details of our range of high quality Kit and manufactured Electronic & Ins. and we operate Telephone BARCLAY-CARD/ACCESS.
Competitive EXPORT Quotations given.

BAND-BOX
An Electronic Backing TRIC. Drums, Bass & Chord Instrument. User Programmable for 50-100 scores, using microprocessor.

Kit £129
VOCAL & INSTRUMENTAL SOLOISTS!

CLEF PRODUCTS (ELECTRONICS) LIMITED
Dept. W, 44a Bramhall Lane South
Bramhall, Stockport, Cheshire SK7 1AH
061-439 3297

WW - 015 FOR FURTHER DETAILS

RADFORD

Audio Measuring Instruments,
Audio Amplifiers, Loudspeakers and
Loudspeaker Components for the
professional and enthusiast

RADFORD AUDIO LTD.

10 BEACH ROAD
WESTON-S-MARE, AVON BS23 2AU
TEL. 0934 416033

WW - 011 FOR FURTHER DETAILS

U.K. RETURN OF POST MAIL ORDER SERVICE, ALSO WORLDWIDE EXPORT SERVICE

RECORD DECKS SINGLE PLAY

Large Turntables
240 volt AC. Post £2

Make	Model	Drive	Cartridge	Price
BSR	P170	Rim	Ceramic	£20
BSR	P232	Belt	Ceramic	£24
GARRARD	G200	Rim	Ceramic	£22
GARRARD	Delux	Belt	Magnetic	£40

Make	Model	Drive	Cartridge	Price
BSR	P232	12 volt	Magnetic	£24
AUTOCHANGERS 240 VOLT				
BSR	Budget	Rim	Ceramic	£16
BSR	Delux	Rim	Ceramic	£18
BSR	Delux	Rim	Magnetic	£26

MAINS PRE-AMP FOR MAGNETIC CARTRIDGES to low gain amplifier. 10mv to 1/2 volt, mono £5, stereo £7. P.&P £1

HEAVY METAL PLINTHS

Cut out for most Garrard decks. Black or silver grey finish. Size 16x13 1/4in. **£4**
DECCA TEAK VENEERED PLINTH. Post £1.50 **£5**
Superior finish with space and panel for small amplifier. Board is cut for B.S.R. 18 1/4in. x 14 1/4in. x 4in. Black/chrome facia trim. Also with boards cut out for Garrard £3. Tinted plastic cover £5

TINTED PLASTIC COVERS			Post £2
17 1/2 x 13 1/2 x 3 1/4in.	£5	18 1/4 x 12 1/2 x 3in.	£5
17 1/4 x 9 3/8 x 3 1/2in.	£3	14 3/8 x 12 1/2 x 2 1/8in.	£5
16 1/2 x 15 x 4 1/2in.	£5	16 3/8 x 13 x 4in.	£5
17 x 12 1/2 x 3 1/2in.	£5	14 1/2 x 13 1/8 x 2 3/4in.	£5
22 3/8 x 13 3/8 x 3in.	£5	17 1/4 x 13 3/4 x 4 1/8in.	£5
21 1/2 x 14 1/4 x 2 1/2in.	£5	21 x 13 7/8 x 4 1/8in.	£5
23 3/4 x 14 x 3 1/8in.	£5	30 3/4 x 13 3/8 x 3 1/4in.	£5

THE "INSTANT" BULK TAPE ERASER £10.50 Post 95p
Suitable for cassettes and all sizes of tape reels. AC mains 200/250V. Hand held size with switch and lead (120 volt to order). Will also demagnetise small tools and computer tapes.
Tape Head Demagnetiser only £5

BATTERY ELIMINATOR MAINS TO 9 VOLT D.C.
Stabilised output, 9 volt 400 m.a. U.K. made in plastic case with screw terminals. Safety overload cut out. Size 5x3 1/4 x 2 1/2in. Transformer Rectifier Unit. Suitable Radios, Cassettes, models, £5. Post £1.

DRILL SPEED CONTROLLER/LIGHT DIMMER KIT. Easy build kit. Controls up to 800 watts AC mains with plastic case 4 x 3 x 1 1/2in, £5, less case £4. For brush motors, power tools, drills and lighting. Post 65p.

R.C.S. LOW VOLTAGE STABILISED POWER PACK KITS £3.95. Post 65p
All parts and instructions with Zener diode printed circuit, mains transformer 240V a.c. Output 6 or 7 1/2 or 9 or 12V d.c. up to 100mA or less. Please state voltage required.

RELAYS. 6V DC 95p. 12V DC £1.25. 18V £1.25. 24V £1.30
ALUMINIUM CHASSIS. 6x4-£1.75; 8x6-£2.20; 10x7-£2.75; 12x8-£2.20; 14x3-£2.50; 16x6-£3.60
ALUMINIUM PANELS. 6x4-55p; 8x6-90p; 14x3-90p; 10x7-£1.15; 12x8-£1.30; 12x5-90p; 16x6-£1.30; 14x9-£1.75; 12x12-£1.80; 16x10-£2.10
ALUMINIUM BOXES. 4x4x1 1/2 £1.20. 4x2 1/2x2 £1.20. 3x2x1 £1.20. 6x4x2 £1.90. 7x5x3 £2.90. 8x6x3 £3.10. 10x7x2 1/2 £3.60. 12x5x3 £3.60. 12x8x3 £4.30.
ALL ANGLE BRACKET 6x3/4x3/4in. 30p.
BRIDGE RECTIFIER 200V PIV 2a £1.4a £1.50. 6a £2.50.
TOGGLE SWITCHES SP 40p. DPST 50p. DPDT 60p.
MINIATURE TOGGLES SP 40p. DPDT 60p.
RESISTORS. 100 to 10M. 1/4W, 1/2W, 1W, 2p; 2W 10p.
Low ohm 1 watt 0.47 to 3.9 ohm 10p.
HIGH STABILITY. 1/2w 2% 10 ohms to 1 meg. 10p.
WIRE-WOUND RESISTORS 5 watt, 10 watt, 15 watt 20p.
PICK-UP CARTRIDGES SONOTONE 9TAHC £3.80.
BSR Stereo Ceramic SC7 Medium Output £2. SC12 £3.
PHILIPS PLUG-IN HEAD. Stereo Ceramic. AU1200 (G306 - GP310 - GP233 - AG3306, £2. A.D.C. QLM 30/3 Magnetic £5. STYLUS most Ceramic a.c., Sonotone, BSR, Garrard Philips Diamond £1.50 ea.
MAGNETIC STYLUS, Sony, JVC, Sanyo, Goldring, etc. £4.
LOCKTITE SEALING KIT DECCA 118. Complete £1.
VALVE OUTPUT Transformers push/pull 15 watt £14; 30W £18; 50W £20; 100W £24. Post £2. 100V/Line 20W £3.75.
MICROSWITCH, 50p. Miniature 65p. SPDT.
ANTEX SOLDERING IRON 'C' 15W £5.25. 25W 'X25' £5.50.
WAFER SWITCHES. 1 1/4" dia. 60p ea.
1P 12W; 2P 2W; 2P 6W; 3P 4W; 4P 2W; 4P 3W.
FERRITE ROD. 6" x 1/2", 6" x 3/8", 8x5/16" 50p
XLR Lead Plug £2.40. Lead socket £2.75
XLR Chassis Plug £2.20. Chassis Socket £2.55.
BANANA 4mm Plugs/Sockets, red/black 20p
JACK PLUGS Mono Plastic 25p; Metal 30p. Sockets 25p.
JACK PLUGS Stereo Plastic 30p; Metal 35p. Sockets 30p.
FREE SOCKETS - Cable end 30p. Metal 45p.
2.5mm and 3.5mm JACK SOCKETS 25p. Plugs 25p.
DIN TYPE CONNECTORS
Sockets 3-pin, 5-pin 15p. Free Sockets 3-pin, 5-pin 25p.
Plugs 3-pin 20p; 5-pin 25p; Speaker plugs 25p; Sockets 15p.
PHONO PLUGS and SOCKETS ea. 20p; Double sockets 30p.
Free Socket for cable end 20p. Screened Phono Plugs 25p.
B.N.C. PLUGS £1. Sockets £1. Free Sockets £1.10.
U.H.F. PLUG 50p. Socket 50p. Reducer 20p. Coupler 50p.
300 ohm TWIN RIBBON FEEDER 10p vd.
300 ohm TWIN 75 ohm AERIAL MATCHING TRANSFORMER £1.
U.H.F. COAXIAL CABLE SUPER LOW LOSS. 75 ohm 25p vd.
COAX PLUGS 30p. COAX SOCKETS 20p. Lead Sockets 65p.
NEON INDICATORS 250V, round 40p. Rectangular 45p.
MORSE CODE TAPPER and BUZZER SET £3.
CAR CASSETTE MECHANISM. 12V Motor Stereo Head £5.

OPUS COMPACT SPEAKERS £22 pair Post £2
TEAK VENEERED CABINET
11 x 8 1/2 x 7in, 15 watts
50 to 1400 c/s, 4 ohm, 8 ohm or 16 ohm
OPUS TWO 15x10 1/2 x 7 3/4in 25 watt
2-way system £39 pair. Post £3

LOW VOLTAGE ELECTROLYTICS Wire ends All 10p ea.
1mf, 2mf, 4mf, 8mf, 10mf, 16mf, 25mf, 30mf, 50mf, 100mf, 250mf, All 15 volts. 22mf/6V/10v; 25mf/6V/10v; 47mf/10V; 50mf/10v; 68mf/10V/16v/25v; 100mf/10v; 100mf/6V/10v; 200mf/10V/16v; 220mf/4V/10V/16v; 330mf/4V/10v; 500mf/6V; 680mf/6V/10v; 1000mf/2.5V/4V/10v; 1500mf/12V; 2200mf/6V/10v; 3300mf/6V; 4700mf/4V. 500mF 12V 15p; 25V 20p; 50V 30p; 100mF 70p 80p. 1000mF 12V 20p; 25V 35p; 50V 50p; 100V £1.20. 2000mF 30V 42p; 40V 60p; 100V £1.40; 1500mF 100V £1.20. 2200mF 63V 90p. 2500mF 50V 70p; 3000mF 50V 65p; 4700mF 30V 75p; 40V £1; 63V £1.80.

NON POLARISED CAPACITORS - REVERSIBLE
1mF 250V 15p; 1.5mF 100V 25p; 2.2mF 250V 30p; 3.3mF 100V 40p; 4.7mF 100V 40p; 10mF 63V 40p; 32mF 50V 25p.

HIGH VOLTAGE ELECTROLYTICS
2/500V 45p 32+32+16/350V 90p 8+16/450V 75p
8/450V 45p 100+100/275V 65p 16+16/350V 80p
16/350V 45p 150+200/275V 70p 32+32/350V 85p
32/500V 95p 32+32+32/325V 75p 32+32/500V £2
32/350V 95p 50+50+50/350V 95p 50+50/300V 50p
50/450V 95p 8+8/500V £1 80+40/500V £2.20

CAPACITORS WIRE END High Voltage
.001, .002, .003, .005, .01, .02, .03, .05 mfd 400V 10p.
.1Mf 400V 14p. 600V 15p. 1000V 25p.
22Mf 150V 12p. 600V 20p. 1000V 30p. 1750V 60p.
47Mf 150V 10p. 400V 25p. 630V 30p. 1000V 60p.
TRIMMERS 30pF, 50pF, 10p, 100pF, 150pF 20p, 500pF 30p.
MICROSWITCH SINGLE POLE CHANGEOVER 40p.
GEARED TWIN GANGES 365+365+25+25p £2.
BRASS SPINDLE EXTENDERS 85p. Couplers 65p.
VERNIER DRIVE DIALS, 36mm £2.50, 50mm £3.
SLOW MOTION DRIVE 6:1 £1.50. Reverse Vernier drive 90p.
TRANSISTOR TWIN GANG. Japanese Replacement £1.
SOLID DIELECTRIC 100pF £1.50

HEATING ELEMENTS, WAFER THIN (Semi Flexible)
Size 11x9x1/8in. Operating voltage 240V, 250W approx. Suitable for Heating Pads, Food Warmers, Convector Heaters, Propagation, etc. Must be clamped between two sheets of metal or ceramic, etc.
ONLY 60p EACH (FOUR FOR £2) POST 50p.

POTENTIOMETERS Carbon Track
5k1 to 2M1. LOG or LIN. L/S 50p. DP 90p. Stereo L/S £1.10. DP £1.30. Edge Pot 5K. SP 45p.

RADIO COMPONENT SPECIALISTS

Books and Components Lists 32p stamps. (Minimum post/packing charge 65p.) Access or Barclaycard Visa. Tel: 01-684 1665 for SAME DAY DESPATCH. Cash prices include VAT.

MINI-MULTI TESTER NEW

De luxe pocket size precision moving coil instrument. Impedance + Capacity - 4000 o.p.v. Battery included.

11 instant ranges measure:
DC volts 5.25, 250, 500.
AC volts 10, 50, 500, 1000.
DC amps 0-250µA, 0-250mA.
Resistance 0 to 600K ohms.

£7.50
Post 65p

De Luxe Range Doubler Model £19.50
50,000 o.p.v. 7x5x2in. Post £1
43 Ranges, 1,000V, AC-DC, 20 meg, etc.

PANEL METERS

50µA, 100µA, 500µA, 1ma, 5ma, 50ma, 100ma, 500ma, 1A, 2 amp, 25 volt, VU, 2 1/4 x 2 x 1 1/4. Stereo VU 3 1/4 x 1 1/2 x 1 in. £4.50 Post 50p

RCS SOUND TO LIGHT CONTROL BOX

Complete ready to use with cabinet size 9x3x5in. 3 channel, 1000 watt each. For home or disco **£27**
OR KIT OF PARTS £19.50 Post £1
Light Boxes, red, yellow, blue, green. £15. Post £2.
Disco bulbs 100 watt, blue, green, yellow, red, amber, screw or bayonet £2 each. Post £1.50 per six.
"FUZZ" lights, red, blue, green, amber, 240V. £23. Post £1
200 Watt Rear Reflecting White Light Bulbs. Ideal for Disco Lights, Edison Screw. 6 for £4, or 12 for £7.50. Post £1.50. Suitable panel mounting holders 85p.

RCS "MINOR" 10 watt AMPLIFIER KIT £14

This kit is suitable for record players, guitars, tape playback, electronic instruments or small PA systems. Two versions available: Mono, £14; Stereo, £20. 10W per channel; size 9 1/2 x 3 x 2in. SAE details. Full instructions supplied. 240V AC mains. Post £1.

RCS STEREO PRE-AMP KIT

All parts to build this pre-amp. Inputs for high, medium or low imp per channel, with volume control and PC Board. Can be ganged to make multi-way stereo mixers **£3.50** Post 65p

MAINS TRANSFORMERS

250-0-250V 80mA, 6.3V 3.5A, 6.3V 1A	£8.00	£2
350-0-350V 250mA, 6.3V 6A CT	£12.00	£2
220V 25ma 6V lamp £3.00	220V 45ma 6V 2 Amp	£4.00
250V 60mA, 6V 2A		£4.75

Step-Up 115V to 240V 150W £9. 250W £10. 500W £12.00 £2

GENERAL PURPOSE LOW VOLTAGE

Tapped outputs available	Price	Post
2 amp. 3, 4, 5, 6, 8, 9, 10, 12, 15, 18, 25 and 30V	£8.00	£2
1 amp. 6, 8, 10, 12, 15, 18, 20, 24, 30, 36, 40, 48, 60	£8.00	£2
2 amp. 6, 8, 10, 12, 15, 18, 20, 24, 30, 36, 40, 48, 60	£10.50	£2
3 amp. 6, 8, 10, 12, 15, 18, 20, 24, 30, 36, 40, 48, 60	£12.50	£2
5 amp. 6, 8, 10, 12, 15, 18, 20, 24, 30, 36, 40, 48, 60	£16.00	£2
5-8-10-16V. 1/2 amp.	£2.50	£1
6V. 1/2 amp.	£2.00	£1
6-0-6V. 1 1/2 amp.	£3.50	£1
9V. 400ma.	£1.50	£1
9V. 3 amp	£4.50	£1
9-0-9V. 50ma	£1.50	£1
9-0-9V. 1 amp	£3.50	£1
10-0-10V. 2 amps	£4.00	£1
10-30-40V. 2 amps	£4.50	£1
12V. 100ma	£1.50	£1
12V. 750 ma	£2.50	£1
12V. 3 amps	£4.50	£1
12-0-12V. 2 amps	£4.50	£1
12-10-17.2A	£1.50	£1
12V. 750 ma	£2.50	£1
12V. 3 amps	£4.50	£1
12-0-12V. 2 amps	£4.50	£1

CHARGER TRANS

6-12 volt 3a	£4.50	£2
6-12 volt 4a	£6.50	£2

RECTIFIERS

6-12 volt 2a	£1.10	80p
6-12 volt 4a	£2.00	80p

OPUS COMPACT SPEAKERS £22 pair

TEAK VENEERED CABINET
11 x 8 1/2 x 7in, 15 watts
50 to 1400 c/s, 4 ohm, 8 ohm or 16 ohm
OPUS TWO 15x10 1/2 x 7 3/4in 25 watt
2-way system £39 pair. Post £3

LOW VOLTAGE ELECTROLYTICS

Wire ends All 10p ea.
1mf, 2mf, 4mf, 8mf, 10mf, 16mf, 25mf, 30mf, 50mf, 100mf, 250mf, All 15 volts. 22mf/6V/10v; 25mf/6V/10v; 47mf/10V; 50mf/10v; 68mf/10V/16v/25v; 100mf/10v; 100mf/6V/10v; 200mf/10V/16v; 220mf/4V/10V/16v; 330mf/4V/10v; 500mf/6V; 680mf/6V/10v; 1000mf/2.5V/4V/10v; 1500mf/12V; 2200mf/6V/10v; 3300mf/6V; 4700mf/4V. 500mF 12V 15p; 25V 20p; 50V 30p; 100mF 70p 80p. 1000mF 12V 20p; 25V 35

ELECTRIC SHOCK

2 WAYS TO RECOVERY

ACT AT ONCE - DELAY IS FATAL

ELECTRIC SHOCK ACT AT ONCE - DELAY IS FATAL

make sure it is safe to approach

if the casualty is not clear of the source of the shock break the contact by switching off all the current removing the plug or

if the casualty is breathing

if the casualty is NOT breathing

start artificial respiration - speed is essential

if AFTER FOUR INFLATIONS casualty does not respond to artificial respiration

external heart compression

external heart compression

external heart compression

external heart compression

external heart compression

external heart compression

external heart compression

external heart compression

external heart compression

external heart compression

external heart compression

external heart compression

external heart compression

external heart compression

external heart compression

external heart compression

external heart compression

external heart compression

external heart compression

external heart compression

external heart compression

external heart compression

external heart compression

external heart compression

external heart compression

external heart compression

external heart compression

external heart compression

external heart compression

external heart compression

external heart compression

external heart compression

external heart compression

external heart compression

external heart compression

external heart compression

external heart compression

external heart compression

external heart compression

external heart compression

external heart compression

external heart compression

external heart compression

external heart compression

external heart compression

external heart compression

external heart compression

external heart compression

external heart compression

external heart compression

external heart compression

external heart compression

external heart compression

external heart compression

external heart compression

Display the ELECTRICAL REVIEW shock first aid chart (356x508mm) supplied in thousands to destinations world-wide. Recent deliveries include consignments to companies in Papua New Guinea, Dubai, United Arab Emirates, The Philippines, apart from UK commercial and industrial, educational, Central Government, Local Authorities' orders.

Carry the ELECTRICAL REVIEW pocket-size shock card (92x126mm) designed to help safety and training officers, medical and welfare personnel; all who might find themselves called to save a life. Always pocket your card; there's a useful two-year calendar on the back.

GET IT - READ IT - PRACTISE 1-4
BE READY TO SAVE A LIFE.
SOMEONE MIGHT SAVE YOURS.

ACT AT ONCE - DELAY IS FATAL!

To Electrical-Electronic Press
General Sales Department
Room 205
Quadrant House
Sutton SM2 5AS
Surrey
England

Company Registered Number: 151537 (ENGLAND)
Registered Office: Quadrant House, The Quadrant
Sutton, Surrey SM2 5AS

Please send copy/copies as indicated

Pocket Card @ 70p each inc VAT
Paper Chart @ £1.00 each post free
Card Chart @ £2.00 each post free
Plastic Chart @ £3.00 each post free

Discounts: 100 + copies 10%
500 + copies 15%

(Overseas surface and air mail rates supplied on application.)

VALVES		Minimum Order £1	VALVES VAT IS INCLUDED									
A1065	1.40	EY51	0.95	U27	1.15	6AT6	0.90	12BA6	0.90	6550	7.20	
A2293	8.80	EY81	0.65	U191	0.85	6AU6	0.60	12BE6	1.25	6874	14.00	
A2900	13.75	EY86/87	0.60	U281	0.70	6AV6	0.85	12BH7	1.95	6973	4.40	
AR8	0.75	EY88	0.65	U301	0.85	6AX4GT	1.30	12BY7A	2.30	7360	10.80	
ARP3	0.70	EZ20	0.70	U600	11.50	6AX5GT	1.30	12C8	0.65	8552	8.20	
ATP4	0.50	EZ21	0.70	U601	0.90	6BA6	0.55	12E1	18.95	39P1	11.00	
B12H	3.90	GM4	5.90	UBC41	1.20	6BE6	0.60	12J5GT	0.55	39P7	18.00	
CY31	1.40	GY501	1.30	UABC80	0.75	6BG6G	1.60	12K7GT	0.70	4EP1	35.80	
DAF96	0.70	GZ32	1.05	UAF42	1.20	6BJ6	1.30	12K8GT	0.80	88J	14.00	
DE122	28.50	GZ33	4.20	UBF80	0.70	6BQ7A	0.85	12Q7GT	0.80	88L	14.00	
DF96	0.70	GZ34	2.75	UBF89	0.70	6BR7	4.80	12SC7	0.65	CU16	15.00	
DH76	0.75	GZ37	3.95	UCC84	0.85	6BW6	6.20	12SH7	0.65	DG7-32	34.80	
DL92	0.60	KT66	10.95	UCC85	0.70	6BW7	1.80	12SJ7	0.70	DG7-36	36.00	
DY86/87	0.85	KT88	16.10	UCF80	1.30	6C4	0.50	12SQ7	1.45	DPMS-11	38.40	
DY802	0.70	KT88	12.85	UCH42	1.65	6C6	0.55	12SQ7GT	0.95	D13-33GM	41.80	
E92CC	2.80	ML6	2.50	UCH42	18.40	6CH6	8.20	12Y4	0.70			
E180CC	4.20	ML6	2.50	UCL82	0.95	6CL6	2.75	13D3	2.80	* spec Q		
E180F	7.70	ML6	2.50	UF41	1.35	6CW4	8.50	13D5	0.90			
E182CC	6.25	MX120/01	UF80	0.95	6CX8	3.80	13D6	0.80	PLUMBICON			
EA76	2.25	N78	21.50	UF85	0.95	6CY5	1.15	14S7	1.15	P800 3LF		
EB9C80	0.90	OA2	0.70	UL84	0.95	6D6	1.15	19A05	2.85	P800R		
EB91	0.60	OB2	0.80	UM80	0.90	6F6	1.60	19G3	11.50	P800IB		
EBC33	1.15	OB2	0.80	UM84	0.70	6F6GB	1.10	19G6	8.50	XQ1020R		
EBC90	0.90	PABC80	0.60	UY82	0.70	6F7	2.80	19H6	39.55	XQ1020B		
EBC90	0.80	PC84	0.75	LY85	0.85	6F8G	0.50	20D1	0.80			
EBF83	0.60	PC86	0.85	VR105/30	1.25	6F12	1.50	20F2	0.60	SPECIAL V		
EBF89	0.80	PC88	0.90	VR150/30	1.35	6F14	1.15	20E1	1.30	4CX 1000A		
EC52	0.85	PC97	1.25	X66	0.95	6F15	1.30	20P1	0.65	4CX 5000A		
EC91	4.40	PC900	0.90	X61M	1.70	6F17	3.20	20P3	0.75	BM 25L		
EC92	0.85	PCC04	0.50	XR1-6400A	0.90	6F19	2.05	20P4	1.25	BM 153		
ECC81	0.85	PCC89	0.85	125.00	6F24	1.75	20P5	2.15	CV6131	2.45	BM 25LB	
ECC82	0.60	PCC189	0.85	Z759	19.00	6F33	10.50	25L6GT	0.95	YL 1420		
ECC83	0.85	PCF80	0.80	Z749	0.75	6F8H	12.50	25Z4G	0.75	YL 1430		
ECC84	0.80	PCF82	0.70	Z800U	3.45	6GA8	1.95	30C15	0.50	YL 1440		
ECC85	0.60	PCF84	0.75	Z801U	3.75	6GH8A	1.60	30C16	0.50	CU16		
ECC88	0.80	PCF86	1.50	Z803U	16.00	6H6	1.60	30C18	2.45	CV1597		
ECC189	0.95	PCF87	0.50	Z900T	2.45	6JU6	5.85	30F5	1.15	CV2116		
ECC804	0.90	PCF200	1.45	1A3	0.85	6J4	1.35	30FL2	1.40	BR 189		
ECF80	0.85	PCF201	1.65	1L4	0.90	6J4WA	2.00	30FL12	1.25	BR 179		
ECF82	0.85	PCF800	0.50	1R5	0.60	6J6C	3.70	30PL13	1.25	MIL 5948/1754		
EF801	1.05	PCF801	1.75	1S4	0.45	6J5GT	0.90	30L15	1.10	GMU 2		
ECH34	2.25	PCF802	0.70	1S5	0.45	6J6	0.65	30L17	1.10	TY4-500		
ECH35	1.70	PCF806	1.20	1T4	0.45	6J6W	0.90	30P12	1.15	BK485/5552A		
ECH36	2.10	PCF808	1.45	1T4	0.80	6J6EC	3.70	30P13	1.25	MIL 5948/1754		
ECH42	0.70	PCL80	1.25	1X2B	1.40	6J59C	3.70	30P14	2.45			
ECH84	0.80	PCL82	0.95	2D21	1.10	6K7	0.80	35L6GT	1.40	IC		
ECL80	0.70	PCL84	0.90	2K25	24.50	6L8M	2.80	35Z4GT	0.80	SN5402N	0.28	
ECL82	0.75	PCL86	0.75	2X2A	79.50	6L8G	2.50	50C5	1.15	SN5410F	0.32	
ECL83	1.40	PC85/85	0.95	3A4	0.70	6L6GC	2.85	6CD6G	1.15	SN54196J	1.20	
ECL85	0.80	PD500/510	4.30	3A4	0.70	6L6GT	1.25	75B1	1.25	SN7407N	0.48	
ECL86	0.90	PFL200	1.10	3AT2	2.40	6L7G	0.65	75C1	1.70	SN7408N	0.18	
EF37A	2.15	PL36	2.80	3B28	12.00	6L8	0.70	76	2.20	SN7445P	0.85	
EF39	1.25	PL81	0.85	3D6	0.50	6L06	2.95	78	2.20	SN74453P	1.10	
EF80	1.75	PL82	0.70	3D22	23.00	6K6A	0.70	80	2.80	SN7451AN	0.32	
EF85	0.60	PL83	0.60	3E29	19.00	6Q7G	1.30		2.55	SN7474N	0.30	
EF86	0.75	PL84	0.95	3S4	0.80	6SA7	1.00	807	1.25	SN7485N	0.95	
EF89	1.00	PL504	1.00	3Z3	18.50	6S7	1.90		1.90	SN7485N	1.10	
EF91	1.50	PL508	2.40	5B/254M	16.90	6S7J	1.05	813	19.32	SN7485N	1.10	
EF92	2.90	PL509	5.65	5B/255M	14.50	6SK7	0.95		68.50	SN74123N	0.42	
EF95	0.65	PL519	5.80	5B/258M	12.50	6SL7GT	0.85	829B	16.00	DM74123N	0.38	
EF96	0.60	PL802(5E)	2.95	5C22	29.90	6SN7GT	0.80	832A	8.90	SN15836N	0.26	
EF183	0.80	PY33	0.70	5R4GY	1.80	6S7	1.10	868A	3.80	CX4	0.95	
EF184	0.80	PY80	0.70	5U4G	0.75	6S7Q	0.95	866E	6.25	SN76013N	1.80	
EF812	0.75	PY81/800	0.85	5V4G	0.75	6V8G	1.50	931A	13.80	SN76003N	1.60	
EFL200	1.85	PY82	0.65	5Y3GT	0.95	6V8GT	0.95	954	1.20	SN76003N	1.30	
EH90	0.85	PY83	0.80	5Z3	1.50	6X4	0.95	955	1.20	MC6800P	5.80	
EL32	1.10	QV03	0.50	5Z4G	0.75	6X4WA	0.10	956	1.20	MC68800P		
EL34	1.80	PY500A	2.10	5Z4GT	1.05	6X5GT	0.65	957	1.70		6.40	
EL37	5.20	PY801	0.80	6AB7	0.70	6Z4	0.90	1625	1.80	MC14511BA		
EL82	0.70	QV03/10	3.20	6AC7	1.15	7B7	1.75	2051	2.90	B1702AL	3.30	
EL84	0.80	QV03	7.50	6AG5	0.80	8N8	2.95	5763	4.80	MM6300-LJ		
EL86	0.95	QV03-20A	6AH6	1.15	9D2	0.70	5842	7.50			3.80	
EL90	1.00	21.50	6AK5	0.85	9D6	2.90	5881	3.90	MC6810AP			
EL91	4.20	QV03-25A	6AK8	0.80	10C2	0.85	5933	6.90				
EL95	0.80	QV06/40A	6AL5W	0.85	10F18	0.70	6057	2.20	6340-1J	3.40		
ELS04	1.70	QV06/40A	6ALS	0.85	10P13	1.50	6080	1.95	MIC945-5D	0.28		
EL803	5.90	16.10	6AM5	4.20	11E2	19.50	6064	2.30	MIC936-5D	0.22		
ELS09	3.95	QV03-12	4.20	6AM6	1.50	12A6	0.70	6065	3.20			
EL821	8.20	SP61	1.80	6AN8A	2.50	12A76	0.70	6067	2.30			
EL822	9.95	TT214	23.00	6AM7	3.40	12A77	0.80	6080	5.80			
ELL80(5E)	2.80	T222	18.50	6A05	1.00	12A17	0.80	6146	5.80			
EM80	0.85	U25	1.15	6A05W</								

LOGIC ANALYSERS

Thandar's comprehensive range of professional specification instruments now includes 8 and 16 channel logic analysers to expand your test capabilities. Both analysers feature DC to 20MHz sampling rates, synchronous or asynchronous clocking and 15ns glitch capture in latch mode. There is also a powerful compound trigger delay by event and/or clock (two level triggering on TA2160), selectable trigger position, variable trigger filter and clock qualifier and arm facilities. All inputs are high impedance with TTL or variable threshold. Both have a composite video output to drive an external display or video printer and offer disassembler options for common microprocessors. Accessories are available for serial data capture and hard copy record printout.

TA2080 (8 CHANNEL) Full system information always shown in display; 8 bit data and reference memories, both 252 bytes deep; 23 bit triggering (8 data bits, 15 trigger bits); Timing display shows all 252 bytes of the 8 data channels in timing diagram format with x1, x4, x8 expansions available; State display shows 24 sequential bytes in either binary plus ASCII or hex plus octal plus ASCII; Automatic or manual compare between recording and reference memories for equality or inequality.

TA2160 (16 CHANNEL) 16 bit data and reference memories, 252 samples deep; Both data and reference memories configurable as 16 bit x 252 samples, 8 bit x 504 samples, or 2 x 8 bit x 252 samples; 34 bit triggering (16 data, 12 trigger and 6 qualifiers); Independent clocks and clock qualifiers in 2 x 8 bit modes; Sample or latch assignable on a per pod basis; Timing display shows 252 bytes of any 8 channels in timing diagram format with x2, x4, x8 expansions available; State display shows 16 sequential store locations of any 4 memories in 4 columns; each memory can be displayed in either binary, hex, octal, decimal, ASCII, or EBCDIC; Automatic or manual compare between any part of any two memories for equality or inequality; TTL or variable threshold assignable on a per pod basis; RS232 interface permits dumping and loading of reference memories and all system parameters.



Send for our complete catalogue and price list.
Thandar Electronics Ltd, London Road, St. Ives,
Huntingdon, Cambridgeshire, PE17 4JH.
Telephone (0430) 64646. Telex 32250.

Thandar
ELECTRONICS LIMITED THE LOGICAL CHOICE

WW - 041 FOR FURTHER DETAILS

CONCEPT 09 Microcomputers

British designed microcomputer systems that bring together the processing power of the 6809 Microprocessor with the renowned FLEX operating system. The cost-effective solution to software development.

Languages:

Basic 'C'
Pascal BCPL
Fortran PL9
Forth

CONCEPT 09 Microsystem

Low cost compact design
MC6809 Microprocessor
Dual 5.25 Disc Drives
56k Dynamic Ram
Serial Console Port
Centronics Printer Port
24 Lines Parallel I/O
Powerful EPROM Monitor
Flex Operating System

£995



Applications:

Word Processors
Spelling Checker
Mail Merge
Dyncalc
Data Base Management

CONCEPT 09 Workstation

High performance, three processor design
MC6809 Main Processor - Full Cursor Control
Dual 5.25 Disc Drives - 56k Dynamic Ram
Serial RS232 Port - Centronics Printer Port
Intelligent Detached Keyboard (6802)
Intelligent VDU Controller (6809)
40/80 by 24 Character Display
Programmable Character Attributes
Up to four selectable character sets
Dumb Terminal Emulation - Non-reflective Display
FLEX Disc Operating System

£1850



Micro Concepts

8 SKILLICORNE MEWS · QUEENS ROAD · CHELTENHAM · GLOUCESTERSHIRE GL50 2NJ · Telephone: Cheltenham (0242) 510525

WW - 056 FOR FURTHER DETAILS

CRICKLEWOOD ELECTRONICS LTD.

40 Cricklewood Broadway, London NW2 3ET. Tel. 01 452 0161. Tlx. 914977.

Here's a selection from our vast stocks. Full price list free on request. Orders by phone quoting credit card no. or by mail order. Callers welcome. All products first grade franchised source. All in-stock items despatched same day. Official orders welcome from Govt. Depts., schools, etc. Please add 60p p&p + 15% VAT. Overseas orders no VAT but allow £2.00 min. p&p. Quantity discounts negotiable.

TRY US NOW - WE'VE GOT WHAT YOU NEED.

<p>RESISTORS</p> <p>CARBON FILM 5% HI-STAR 100 to 10MΩ 1/4W E24 2p 1/2W E24 2 1/2p 1W E12 6p 2W E12 12p</p> <p>METAL FILM ULTRA STABLE 0.4W EXTRA LOW NOISE 100 to 1MΩ 1/2W 1MΩ 2% E24 5p 1% E24 5p</p> <p>LOW OHMIC GLAZE 1/4W 0.22Ω to 9.2Ω E24 11p</p> <p>WIREWOUND ON CERAMIC E12 SERIES 0.2 to 3 WATT 0.2 to 3000 28p 4 to 7 WATT 0.47Ω to 68Ω 33p 10 to 11 WATT 1Ω to 30K 33p</p> <p>30K 33p POTS & PRESETS</p> <p>ROTARY POTS LOW NOISE 1/4W PINPLES E3 SERIES 4K7 to 2M 11N 32p 4K7 to 2M LOG 2M 32p As above with DP mains 79p As above stereo (no switch) 89p</p> <p>RADIALS PCB IDUSTPROOF E31 SERIES Mini Vertical 15p Mini Horizontal 15p Standard Vert 18p Standard Horiz 18p</p> <p>CERMET 20 TURN PRECISION PRE-SETS E3 Series 50Ω to 500K 89p</p> <p>CAPACITORS</p> <p>CERAMIC 100V DISC (PLATE) E12 MICRO MINI typically ±5% 1pF to 10nF 7p</p> <p>POLYCARB 5% SIEMENS 7.5mm MINI-BLOC E12 250V 100nA 95p 1A 2.65 1nF to 68nF 7p 8n2 to 150nF 8p 500F to 150nF 10p 100nF to 150nF 11p 180nF to 270nF 330nF to 560nF 26p 680F 30p 10µF 10mm 35p</p> <p>POLYESTER 250V RADIAL (C280) 10nF, 15nF, 22nF, 33nF, 47nF, 82nF, 100nF 3.75 - 3.75 99p 3.75 - 5 1.14 3.75 - 10 2.99 3.75 - 17 3.85 4.7 - 17 4.93 VO Board 1.92 18 swg 2.95 Track Cutter 1.48 100 Pins 55p Veroblock 3.99 Vero Wiring Pen + Spool 3.35 Spare Spool 75p Combs 6p</p> <p>TANT BEADS 1.35V 14p 2.2 35V 14p 3.3 35V 14p 47 35V 14p 82 35V 14p 10 35V 14p 2.2 35V 14p 3.3 35V 18p 4.7 35V 20p 6.8 25V 20p 6.8 25V 21p 10 16V 18p 10 35V 27p 15 10V 22p 15 16V 30p 15 25V 32p 22 6.3V 28p 22 16V 28p 33 10V 30p 47 3V 14p 47 6.3V 34p 47 16V 34p 100 13V 32p 100 10V 55p</p> <p>ELECTROLYTICS Mainly Matsushita Siemens 420 - 195mm 240 - 245mm 195p</p> <p>AXIALS (Wires each end)</p> <p>µF V 47 100 9p 47 100 9p 47 30 8p 1 83 8p 1 100 9p 1 500 40p 2.2 25 8p 2.2 63 9p</p>	<p>Single sided 100 - 160 1.55 100 - 220 1.90 203 - 114 1.85 233 - 220 3.99</p> <p>Double sided 100 - 160 1.55 100 - 220 1.90 203 - 114 2.21 233 - 220 4.55</p> <p>Developer for above (do not use Sodium Hydroxide) 2.50</p> <p>WIRE & CABLE</p> <p>Prices per Metre Main connecting 16W 5p 3 Core 2.5 amp 15p Twin 1 amp 14p Twin 2.5 amp 16p</p> <p>Mains/Spkr Cable 16W 5p Twin 2.5 amp 15p 3 Core 2.5 amp 15p</p> <p>Screened Cable Single 14p 4 to 7 WATT 27p Mini Single 12p Mini Stereo 15p 4 Core 4 Screens 44p</p> <p>9 Core 54p 12 Core 61p Aerial Cable 50Ω RG58A 36p 75Ω VHF 36p 75Ω VLF 26p 300Ω Flat 14p Rainbow Ribbon Cable per foot 8 Way 25p 10 Way 25p 20 Way 39p 30 Way 48p 40 Way 88p 64 Way 149p</p> <p>RECHARGEABLE BATTERIES</p> <p>Top quality Don't throw these but charge up them times! 1.00 times! HP2 (1.2AH) 2.10 HP2 (4AH) 4.75 HP7 (1/4AH) 9.90 HP11 (1.2AH) 2.29</p> <p>TRANSFORMERS</p> <p>All 240V Primary 6.0V 6.0 9.0V 12.0 12V 15.0 15V 100mA 95p 1A 2.65</p> <p>20.0 20V 12.0 12.0 10.0 10.0 0.6 - 6 - 9 - 9 1.25A 4.25 1.25A 4.25</p> <p>These goods are heavy sized extra credit any will differ</p> <p>VEROBORD</p> <p>0.1 COPPER TRACKS No. 2 Small 85p No. 3 Med 85p No. 6 Micro 85p Bits XS240 No. 50 Small 85p No. 51 Med 85p No. 52 (L) Med 85p SOLDER 125gms 18 swg 2.95 22 swg 3.10</p> <p>PLUGS & SOCKETS</p> <p>D Connectors Solder Male 1.60 Female 2.09</p> <p>PCB WIRE WRAP</p> <p>Male 2.60 Female 2.09 Covers £1.00</p> <p>PHONO PLUGS</p> <p>Bk. Red. Grn. Wh. or Yellow 15p Line Sks 15p Chas. Skt - 120p Dual 30p Quark 40p</p> <p>ETCH RESIST TRANSFERS</p> <p>1 Thin lines 2 Thick lines 3 Thin bends 4 Thick bends 5 DIL pads 6 Transistor pads 7 Dots - holes 8 0.1" edge cons 9 Mixture Any sheet of above 35p</p> <p>GRADE ONE GLASS PCB Single Sided 2N218 33p 2N219 27p 2N221A 25p 2N222 22p 2N222A 24p 2N222B 24p 2N222C 2.60 2N222D 2.60 2N222E 4.15 2N222F 24p</p> <p>PHOTO SENSITIVE PCB 1st Class Epoxy Glass For better results than epoxy ing. Expose to UV</p>	<p>2N2905 28p 2N2905A 29p 2N2906 25p 2N2906A 30p 2N2907 25p 2N2907A 26p 2N2920 31p 2N2923 25p 2N2924 15p 2N2925 15p 2N2926 15p 2N3053 27p 2N3054 56p 2N3055 60p 2N3056 100p 2N3250 36p 2N3251 36p 2N3252 37p 2N3440 80p 2N3441 1.25 2N3442 1.95 2N3443 1.85 2N3444 4.80 2N3445 5.72 2N3446 6.09 2N3447 5.72 2N3448 5.85 2N3468 1.00 2N3612 1.06 2N3615 2.65 2N3635 55p 2N3638A 70p 2N3702 10p 2N3703 10p 2N3704 10p 2N3705 10p 2N3706 10p 2N3707 10p 2N3708 10p 2N3710 10p 2N3711 10p 2N3712 2.00 2N3713 1.38 2N3714 1.38 2N3715 3.31 2N3716 3.60 2N3717 3.60 2N3718 3.60 2N3719 3.60 2N3820 38p 2N3821 1.84 2N3822 1.84 2N3823 4.5p 2N3824 4.5p 2N3825 4.5p 2N3826 4.5p 2N3827 4.5p 2N3828 4.5p 2N3829 4.5p 2N3830 4.5p 2N3831 4.5p 2N3832 4.5p 2N3833 4.5p 2N3834 4.5p 2N3835 4.5p 2N3836 4.5p 2N3837 4.5p 2N3838 4.5p 2N3839 4.5p 2N3840 4.5p 2N3841 4.5p 2N3842 4.5p 2N3843 4.5p 2N3844 4.5p 2N3845 4.5p 2N3846 4.5p 2N3847 4.5p 2N3848 4.5p 2N3849 4.5p 2N3850 4.5p 2N3851 4.5p 2N3852 4.5p 2N3853 4.5p 2N3854 4.5p 2N3855 4.5p 2N3856 4.5p 2N3857 4.5p 2N3858 4.5p 2N3859 4.5p 2N3860 4.5p 2N3861 4.5p 2N3862 4.5p 2N3863 4.5p 2N3864 4.5p 2N3865 4.5p 2N3866 4.5p 2N3867 4.5p 2N3868 4.5p 2N3869 4.5p 2N3870 4.5p 2N3871 4.5p 2N3872 4.5p 2N3873 4.5p 2N3874 4.5p 2N3875 4.5p 2N3876 4.5p 2N3877 4.5p 2N3878 4.5p 2N3879 4.5p 2N3880 4.5p 2N3881 4.5p 2N3882 4.5p 2N3883 4.5p 2N3884 4.5p 2N3885 4.5p 2N3886 4.5p 2N3887 4.5p 2N3888 4.5p 2N3889 4.5p 2N3890 4.5p 2N3891 4.5p 2N3892 4.5p 2N3893 4.5p 2N3894 4.5p 2N3895 4.5p 2N3896 4.5p 2N3897 4.5p 2N3898 4.5p 2N3899 4.5p 2N3900 4.5p</p>	<p>40411 2.85 40412 90p 40413 90p 40414 90p 40415 90p 40416 90p 40417 90p 40418 90p 40419 90p 40420 90p 40421 90p 40422 90p 40423 90p 40424 90p 40425 90p 40426 90p 40427 90p 40428 90p 40429 90p 40430 90p 40431 90p 40432 90p 40433 90p 40434 90p 40435 90p 40436 90p 40437 90p 40438 90p 40439 90p 40440 90p 40441 90p 40442 90p 40443 90p 40444 90p 40445 90p 40446 90p 40447 90p 40448 90p 40449 90p 40450 90p 40451 90p 40452 90p 40453 90p 40454 90p 40455 90p 40456 90p 40457 90p 40458 90p 40459 90p 40460 90p 40461 90p 40462 90p 40463 90p 40464 90p 40465 90p 40466 90p 40467 90p 40468 90p 40469 90p 40470 90p 40471 90p 40472 90p 40473 90p 40474 90p 40475 90p 40476 90p 40477 90p 40478 90p 40479 90p 40480 90p 40481 90p 40482 90p 40483 90p 40484 90p 40485 90p 40486 90p 40487 90p 40488 90p 40489 90p 40490 90p 40491 90p 40492 90p 40493 90p 40494 90p 40495 90p 40496 90p 40497 90p 40498 90p 40499 90p 40500 90p</p>	<p>BC547A 14p BC547B 14p BC548 12p BC549 13p BC548B 15p BC548C 15p BC549B 14p BC549C 15p BC550 15p BC551 15p BC552 15p BC553 15p BC554 15p BC555 15p BC556 15p BC557 15p BC558 15p BC559 15p BC560 15p BC561 15p BC562 15p BC563 15p BC564 15p BC565 15p BC566 15p BC567 15p BC568 15p BC569 15p BC570 15p BC571 15p BC572 15p BC573 15p BC574 15p BC575 15p BC576 15p BC577 15p BC578 15p BC579 15p BC580 15p BC581 15p BC582 15p BC583 15p BC584 15p BC585 15p BC586 15p BC587 15p BC588 15p BC589 15p BC590 15p BC591 15p BC592 15p BC593 15p BC594 15p BC595 15p BC596 15p BC597 15p BC598 15p BC599 15p BC600 15p BC601 15p BC602 15p BC603 15p BC604 15p BC605 15p BC606 15p BC607 15p BC608 15p BC609 15p BC610 15p BC611 15p BC612 15p BC613 15p BC614 15p BC615 15p BC616 15p BC617 15p BC618 15p BC619 15p BC620 15p BC621 15p BC622 15p BC623 15p BC624 15p BC625 15p BC626 15p BC627 15p BC628 15p BC629 15p BC630 15p BC631 15p BC632 15p BC633 15p BC634 15p BC635 15p BC636 15p BC637 15p BC638 15p BC639 15p BC640 15p BC641 15p BC642 15p BC643 15p BC644 15p BC645 15p BC646 15p BC647 15p BC648 15p BC649 15p BC650 15p BC651 15p BC652 15p BC653 15p BC654 15p BC655 15p BC656 15p BC657 15p BC658 15p BC659 15p BC660 15p BC661 15p BC662 15p BC663 15p BC664 15p BC665 15p BC666 15p BC667 15p BC668 15p BC669 15p BC670 15p BC671 15p BC672 15p BC673 15p BC674 15p BC675 15p BC676 15p BC677 15p BC678 15p BC679 15p BC680 15p BC681 15p BC682 15p BC683 15p BC684 15p BC685 15p BC686 15p BC687 15p BC688 15p BC689 15p BC690 15p BC691 15p BC692 15p BC693 15p BC694 15p BC695 15p BC696 15p BC697 15p BC698 15p BC699 15p BC700 15p BC701 15p BC702 15p BC703 15p BC704 15p BC705 15p BC706 15p BC707 15p BC708 15p BC709 15p BC710 15p BC711 15p BC712 15p BC713 15p BC714 15p BC715 15p BC716 15p BC717 15p BC718 15p BC719 15p BC720 15p BC721 15p BC722 15p BC723 15p BC724 15p BC725 15p BC726 15p BC727 15p BC728 15p BC729 15p BC730 15p BC731 15p BC732 15p BC733 15p BC734 15p BC735 15p BC736 15p BC737 15p BC738 15p BC739 15p BC740 15p BC741 15p BC742 15p BC743 15p BC744 15p BC745 15p BC746 15p BC747 15p BC748 15p BC749 15p BC750 15p BC751 15p BC752 15p BC753 15p BC754 15p BC755 15p BC756 15p BC757 15p BC758 15p BC759 15p BC760 15p BC761 15p BC762 15p BC763 15p BC764 15p BC765 15p BC766 15p BC767 15p BC768 15p BC769 15p BC770 15p BC771 15p BC772 15p BC773 15p BC774 15p BC775 15p BC776 15p BC777 15p BC778 15p BC779 15p BC780 15p BC781 15p BC782 15p BC783 15p BC784 15p BC785 15p BC786 15p BC787 15p BC788 15p BC789 15p BC790 15p BC791 15p BC792 15p BC793 15p BC794 15p BC795 15p BC796 15p BC797 15p BC798 15p BC799 15p BC800 15p</p>	<p>4300 4.95 4301 4.95 4302 4.95 4303 4.95 4304 4.95 4305 4.95 4306 4.95 4307 4.95 4308 4.95 4309 4.95 4310 4.95 4311 4.95 4312 4.95 4313 4.95 4314 4.95 4315 4.95 4316 4.95 4317 4.95 4318 4.95 4319 4.95 4320 4.95 4321 4.95 4322 4.95 4323 4.95 4324 4.95 4325 4.95 4326 4.95 4327 4.95 4328 4.95 4329 4.95 4330 4.95 4331 4.95 4332 4.95 4333 4.95 4334 4.95 4335 4.95 4336 4.95 4337 4.95 4338 4.95 4339 4.95 4340 4.95 4341 4.95 4342 4.95 4343 4.95 4344 4.95 4345 4.95 4346 4.95 4347 4.95 4348 4.95 4349 4.95 4350 4.95 4351 4.95 4352 4.95 4353 4.95 4354 4.95 4355 4.95 4356 4.95 4357 4.95 4358 4.95 4359 4.95 4360 4.95 4361 4.95 4362 4.95 4363 4.95 4364 4.95 4365 4.95 4366 4.95 4367 4.95 4368 4.95 4369 4.95 4370 4.95 4371 4.95 4372 4.95 4373 4.95 4374 4.95 4375 4.95 4376 4.95 4377 4.95 4378 4.95 4379 4.95 4380 4.95 4381 4.95 4382 4.95 4383 4.95 4384 4.95 4385 4.95 4386 4.95 4387 4.95 4388 4.95 4389 4.95 4390 4.95 4391 4.95 4392 4.95 4393 4.95 4394 4.95 4395 4.95 4396 4.95 4397 4.95 4398 4.95 4399 4.95 4400 4.95 4401 4.95 4402 4.95 4403 4.95 4404 4.95 4405 4.95 4406 4.95 4407 4.95 4408 4.95 4409 4.95 4410 4.95 4411 4.95 4412 4.95 4413 4.95 4414 4.95 4415 4.95 4416 4.95 4417 4.95 4418 4.95 4419 4.95 4420 4.95 4421 4.95 4422 4.95 4423 4.95 4424 4.95 4425 4.95 4426 4.95 4427 4.95 4428 4.95 4429 4.95 4430 4.95 4431 4.95 4432 4.95 4433 4.95 4434 4.95 4435 4.95 4436 4.95 4437 4.95 4438 4.95 4439 4.95 4440 4.95 4441 4.95 4442 4.95 4443 4.95 4444 4.95 4445 4.95 4446 4.95 4447 4.95 4448 4.95 4449 4.95 4450 4.95 4451 4.95 4452 4.95 4453 4.95 4454 4.95 4455 4.95 4456 4.95 4457 4.95 4458 4.95 4459 4.95 4460 4.95 4461 4.95 4462 4.95 4463 4.95 4464 4.95 4465 4.95 4466 4.95 4467 4.95 4468 4.95 4469 4.95 4470 4.95 4471 4.95 4472 4.95 4473 4.95 4474 4.95 4475 4.95 4476 4.95 4477 4.95 4478 4.95 4479 4.95 4480 4.95 4481 4.95 4482 4.95 4483 4.95 4484 4.95 4485 4.95 4486 4.95 4487 4.95 4488 4.95 4489 4.95 4490 4.95</p>
---	---	--	---	--	--

THE Northern Computer Fair

Personal computers
Home computing
Small business systems

Sponsored by:

Practical Computing and YOUR COMPUTER



The right place The right time

Following the overwhelming success of the 1982 Northern Computer Fair, the sponsors announce that an even bigger and better show will be held again this year at Belle Vue, Manchester, from November 24th-26th

This is the North's premier exhibition for the rapidly expanding home and small business computer market, mounted at a time now recognised as a peak buying period for this type of equipment. It is now one of a nationwide series of exhibitions designed to attract the broadest possible cross-section of both home computer enthusiasts and the rapidly increasing body of personal computer users found throughout business and the professions.

Make a date for Belle Vue, Manchester, November 24-26, 1983, and post the coupon below for more details.

Belle Vue, Manchester, November 24-26, 1983.

THE Northern Computer Fair
Personal computers
Home computing
Small business systems

The Exhibition Manager, Northern Computer Fair, Reed Exhibitions, Surrey House, 1 Throwley Way, Sutton, Surrey SM1 4QQ

I am interested in exhibiting.

Name _____
Position _____
Company _____
Address _____
Telephone _____

If you can buy it cheaper we'll refund the difference.*

This month's offer is another winner — a consignment of 14" R.G.B. colour monitors manufactured by J.V.C. — at prices never seen before in the U.K. Suitable for use with BBC Micro,

Lynx, Oric, Apple II, Apple III and IBM etc. It's safe to put a cheque in the post today. Because, if you find someone who's cheaper, we'll refund the difference.

RGB MEDIUM RES £199.00

Resolution, 370 x 235. Pixels. Display, 80 characters x 25 lines. Slot Pitch 63mm. Input, Video — RGB Analogue with TTL input. SYNC — Separate SYNC on RGB. Features, On/Off switch with pilot light. Brightness control. Power 220/240V 50/60HZ.

RGB HIGH RES £299.00

Resolution, 580 x 235 Pixels. Display, 80 characters x 25 lines. Slot pitch 41mm. Input, Video — RGB Analogue with TTL input. SYNC — Separate SYNC ON RGB. Features, On/Off switch with pilot light. Brightness control. Power, 220/240V 50/60HZ

IBM COMPATIBLE £349.00

Spec as above with IBM Interface.

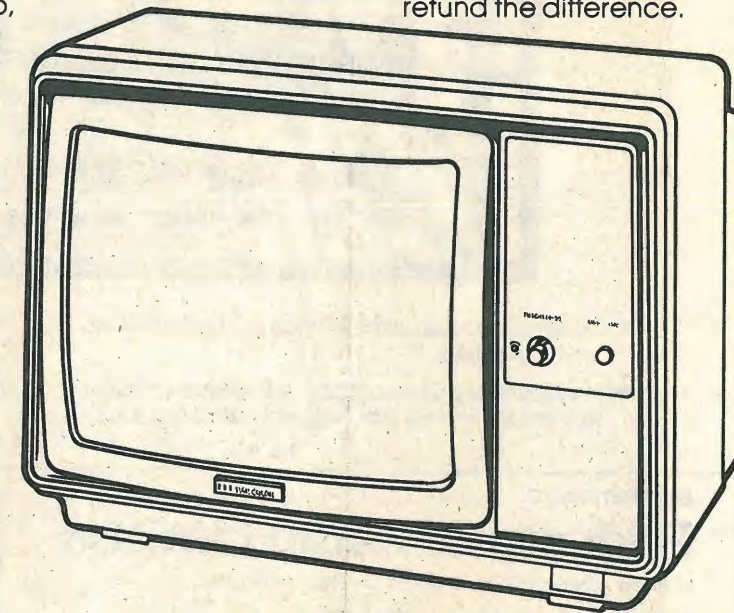

TEAC DISC DRIVES

TEAC 55F — 5 1/4" D/S 80 track. Formatted single density 400K Double density 800K. **only £229.00**

Case to hold two drives with power supply and blanking plate. **only £39.95**

Ribbon lead to connect one drive to BBC. **£12.00**

Dual Ribbon lead **£15.00**

Power lead to connect one drive to BBC. **£5.00**

Ideal for use with BBC Micro. Full warranty. Low power consumption. Slimline latest technology. Switchable 40/80 track.

CANON DISC DRIVES

MDD 6106 5 1/4" S/S 40 track. Formatted single density 100K. Double density 200K. **£129.95**

Case to hold single drive. **£9.95**

Leads as with TEAC DRIVES

THE ORGANIZER DESK

At last a desk designed for the personal user. Full size desk. Suitable for all leading micros. On castors. Teak finish. DEALER ENQUIRIES INVITED. **only £49.50**

DOG FIGHT

If you have a BBC 32K with any O.S. become a flying ace with our wonderful new game Dogfight. An exciting 2 player game with 8 levels of difficulty. **only £8.65**

12" GREEN SCREEN MONITOR

One year warranty, ex stock delivery, 18 MHZ, Phono connector. Limited quantity. **only £69.95**

Lead to connect to BBC **£5.95**

NASHUA FLOPPY DISCS

Minis	8" Discs
S/S/D £16.95 for 10	S/S/D £17.95 for 10
S/S/D/D £19.95 for 10	S/S/D/D £23.95 for 10
D/S/D/D £22.95 for 10	D/S/D/D £24.95 for 10
S/S 80 Track £24.95 for 10	
D/S 80 Track £26.95 for 10	

With full 5 year warranty. All mini discs have hub rings and a FREE plastic library case.

8" DISC DRIVES SHUGART COMPATIBLE

FD514 S/S Dual density. Formatted 600K Byte **only £149.00**

FD650 D/S Dual density. Formatted 1.2M Byte **only £199.50**

Pertec 90 day warranty.

Case to hold 2 drives — complete with power supply and fan. **only £99.95**

VIEW DATA TERMINALS

Prestel, Built in modem. G.P.O. approved, slimline design. **only £199.00**

*Our price pledge only applies to the JVC monitor

To order: Add carriage at the following rates: — Discs 85p. Other goods £7.00. Add VAT at 15% to total and send your order to:

OPUS SUPPLIES

158, Camberwell Road, London SE5 0EE
Tel: 01-701-8668 (3 lines) 01-703-6155/6/7



Government and educational orders welcome.



WW - 058 FOR FURTHER DETAILS

MARK 1983 WITH GAPS IN CIRCUIT FILES WELL-PLUGGED

WIRELESS WORLD CIRCARDS last year benefited many 'new generation' readers who bought at 1976 bargain prices + 10% discount for 10 sets! Most sets are still available although companion volumes **CIRCUIT DESIGNS 1, 2 and 3** are out of print (CIRCARDS sets 1 to 30).

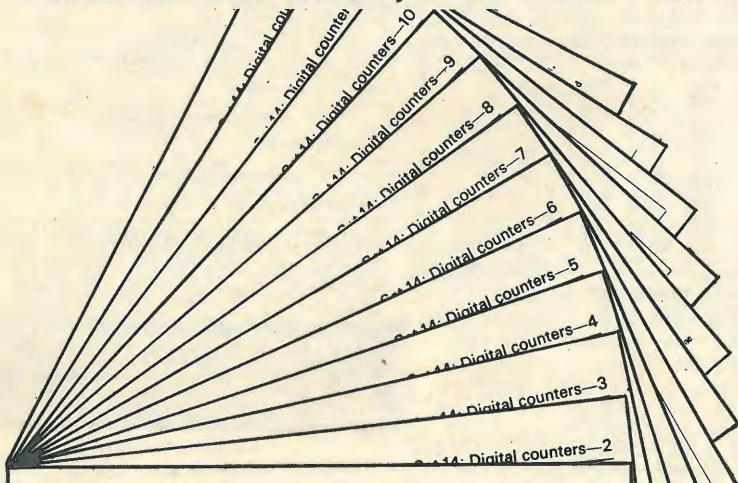

wireless world circard Set 14: Digital counters—1

Basic binary counters

Typical data
 Single bistable
 Vcc: +12V
 Tr, T₂: BC108
 R₁, R₂: 3.3kΩ ±10%
 R₃, R₄: 8.2kΩ ±10%
 R₅, R₆: 6.8kΩ ±10%
 C₁, C₂: 80pF
 D₁, D₂: 95101
 Frequency 100kHz typically
 Trigger input is 4V
 Trigger input width < 1μs

Circuit operation
 The bistable circuit is a T-type "flip-flop" in which the output changes state for a negative-going transition at the trigger input. If the base-drive current is arranged so that Tr is in saturation, its collector voltage will be about 0.2V. This is too low to forward-bias the base-emitter junction of Tr, and hence Tr will be off. This means its collector-emitter voltage is high, depending on R₁ and R₂, and the base-drive current for Tr flows through R₁ and R₂. Hence the terminals identified (arbitrarily) as Q and Q-bar are low and high respectively (0 and 1 for binary coding). When the trigger input is high, the circuit is in a stable state. When the trigger input is driven near ground the negative-going pulse-edge is stored to Tr base

as D₁ is forward-biased. The anode of D₁ is approximately at V_{cc} and because its cathode is connected to a high potential via R₁, it is reverse-biased. Therefore Tr collector current is reduced, causing a rise in its collector voltage, increasing base-drive current to Tr. This causes Tr collector voltage to drop and Tr base current decreases causing a further increase in Tr collector voltage. The process continues until the other stable state, Tr conducting and Tr₂ off, is sustained. The next negative-going trigger pulse resets the circuit to its previous state. It produces one output pulse for every two trigger pulses. The interconnection of these bistable circuits to give a binary ripple counter demands that the Q output of a previous flip-flop is connected to the trigger (or T-) input of the next flip-flop. This gives a natural count of 2ⁿ where n is the number of stages, and 2ⁿ is the number of states through which the counter progresses.

Circuit modification
 Range of R₁, R₂: 4.7k to 47kΩ
 Frequency variation: 150 to 30kHz
 Range of C₁, C₂: 330 to 3300pF
 Frequency variation: 140 to 50kHz
 Increase turn-on speed with capacitors across resistors R₁ and R₂, typically 5 to 20% of C₁, C₂
 Increased frequency of operation possible with additional diodes connected

The Offer stands, so order now your sets of 127 x 204mm cards in plastic wallets. These unique circuit cards normally contain descriptions and performance data of 10 tested circuits, together with ideas for modifying them to suit special needs.

- 1 Basic Active filters 2 Switching Circuits, comparators and Schmitts (But these gaps cannot be filled) *
 6 Constant current circuits 7 Power amplifiers 8 Astable circuits 9 Optoelectronics 10 Micro power circuits 11 Basic logic gates 12 Wideband amplifiers 13 Alarm circuits 14 Digital Counters 15 Pulse modulators 16 Current differencing amplifiers - signal processing 17 Current differencing amplifiers - signal generation 18 Current differencing amplifiers - measurement and detection 19 Monostable circuits 20 Transistor pairs 21 Voltage-to-frequency converters 22 Amplitude modulation and detection 23 Reference circuits 24 Voltage regulators 25 RC oscillators - 1 26 RC oscillators - 2 27 Linear cmos - 1 28 Linear cmos - 2 29 Analogue multipliers 30 Rms/log/power laws 31 Digital multipliers 32 Transistor arrays 33 Differential and bridge amplifiers 34 Analogue gate applications - 1 35 Analogue gate applications - 2.
 *Photocopies only: 3 Waveform generators 4A.C. measurement 5 Audio circuits @ £3.20 each set.

To Electrical-Electronic Press
 General Sales Department
 Room 108
 Quadrant House
 Sutton
 Surrey SM2 5AS
 Company Registered Number: 151537 (ENGLAND).
 Registered Office: Quadrant House, The Quadrant
 Sutton, Surrey SM2 5AS

Please send me the following sets of
 Circards.....£2 each,
 £18 for 10 post free.
 Remittance enclosed payable
 to BUSINESS PRESS INTERNATIONAL LIMITED
 Name (Please print)
 Address (Please print).....

Superior Quality Precision Made NEW POWER RHEOSTATS

New ceramic construction, heavy duty brush assembly, continuously rated.
 25 WATT 5/10/25/50/100/150/250/300/500/1kΩ 1.5kΩ £3.10 + 30p p&p (£3.91 inc. VAT)
 50 WATT 250Ω £5.50 + 50p p&p (£6.90 inc. VAT).
 100 WATT 1/5/10/25/50/100/250/500/1kΩ/1.5kΩ/2.5kΩ/3.5kΩ £7.25 + 75p p&p (£9.20 inc. VAT)
 Black Silver Skirted Knob calibrated in Nos. 1-9, 1/2in dia. brass bush. Ideal for above Rheostats 30p ea. + VAT.

VARIABLE VOLTAGE TRANSFORMERS

INPUT 230/240V a.c. 50/60 OUTPUT 0-260V

200W 1 amp inc. a.c. voltage	£15.00
0.5 KVA (2 1/2 amp MAX)	£19.00
1 KVA (5 amp MAX)	£25.00
2 KVA (10 amp MAX)	£41.00
3 KVA (15 amp MAX)	£49.00
5 KVA (25 amp MAX)	£79.00
10 KVA (50 amp MAX)	£174.00
15 KVA (75 amp MAX)	£270.00

GEARED MOTORS

5rpm 240V A.C. Mf. by Carter. £6.05 £1 p&p (£8.11 inc. VAT)
 7 1/2rpm Motor approx 30lb in. 110V A.C. complete with Transformer for 240V A.C. £10.75 + £1.50 p&p (total inc. VAT £14.09)

71rpm WYNSCALE motor approx. 10lb in. A.C. supplied with auto transformer 240V. A.C. operation. £10.75 p&p £1.50 (£14.09 inc. VAT). N.M.S.

CROWN 42 rpm 110/230V A.C. 50 Hz. 100 lb.in. approx. reversible geared Motor. Price £18.15 + £2.50 p&p (total incl. VAT £23.75)

38.3 rpm GEARED MOTOR. Torque 35lb.in. reversible 115V AC inc. start capacitor. Price £11.55 + £2 p&p (total incl. VAT £15.58) N.M.S. Suitable TRANSFORMER 230V A.C. operation. Price £4.50 + 50p p&p (total incl. VAT £5.75).

SOLID STATE E.H.T. UNIT

Input 230V A.C. Fully isolated. Approx. 15KV. Built-in 10 sec. Timer. Easily modified for 20 sec. 30 sec. to continuous operation. Size 155x85x50mm. Price £5 + 75p p&p (Total inc. VAT £6.61).

3-PHASE VARIABLE VOLTAGE TRANSFORMERS

Dual input 200-240V or 380-415V. Star connected

3 KVA 5 amp per phase max	£113.40
6 KVA 10 amp per phase max	£170.10
10 KVA 16 amp per phase max	£345.45

All plus carriage and VAT

N.E.C. GEARED MOTOR. 152 rpm. 200lb.in. 230V A.C. 50Hz. Ratio 9.2 to 1. Non reverse. Incl. capacitors. Fraction of maker's price. £41.25 + Carr + VAT. N.M.S.

240V A.C. SOLENOID VALVE

Designed for Air/Gas at 0-7. Water 5 psi. Inlet/outlet 3/8". Forged brass body. Manuf. Dewaswitch Asco. Price: £5.80 + £1 p&p (£7.48 inc. VAT). N.M.S.

Comprehensive range of L.T., AUTO (110-240V), ISOLATION TRANSFORMERS available for immediate delivery. Leaflet on request.

INDUSTRIAL STROBE KIT

Ideal for Industrial and Educational purposes. Produces high intensity flash variable from approx. 1 to 70 f.p.s. Price less case £27 + £2 p&p (total incl. VAT £33.36).

ULTRA VIOLET BLACK LIGHT FLUORESCENT TUBES

4ft 40 watt £8.70 inc. VAT £10.00 (callers only).
 2ft 20 watts £8.20. Post £1.25 (£8.57 inc. VAT & p&p).
 (For use in standard bi-pin fittings).
 12in 8 watt £3.00. + 45p (£3.97 inc. VAT p&p).
 9in 6 watt £2.50. + 45p (£3.39 inc. VAT p&p).
 6in 4 watt £2.50. + 45p (£3.39 inc. VAT p&p).
 Complete ballast unit for either 6V, 9V or 12V tube 230V AC op. £5.50 Post 55p (£6.96 inc. VAT p&p). Also available for 12V DC £5.50 Post 55p (£6.96 inc. VAT p&p).

EPROM ERASURE KIT

Why waste money? Build your own EPROM ERASURE for a fraction of the price of a made-up unit. Complete kit of parts less case, to include 12" 8 watt 2537 Angst Tube. Ballast unit, pair of bi-pin leads. Neon indicator, safety microswitch, on/off switch and circuit. LESS CASE. Price: £13.60 + 75p p&p. (Total incl. VAT £16.50).
 Warning: Tube used in this circuit is highly dangerous to the eyes. Unit MUST be fitted in suitable case.

HY-LYGT Mk V. Designed for Disco, Theatrical uses, etc

Approx. 4 sec. Adjustable speed. Price £27 + £2 p&p (Total incl. VAT £33.36). Case and reflector price £12.50 + £2 p&p (total incl. VAT £16.68). Foolsap SAE for further details including Super Hy-Lyght. Suitable case and reflector for either of above kits, price: £12.50 + £2 p&p (total incl. VAT £16.68).

BLACK LIGHT BULBS

Self-ballasted Mercury U.V. 175W Bulbs. Available for either B.C. or E.S. fitting. Price £11.79 incl. p&p and VAT.
 12in 8 watt £3.00. + 45p (£3.97 inc. VAT p&p).
 400W UV LAMP AND BALLAST complete £38.00 post £3.50 (£47.73 inc. VAT & p&p). 400W UV LAMP only £14.00 post £2.00 (£18.40 inc. VAT & p&p).

FROM STOCK AT PRICES THAT DEFY COMPETITION!

DC GEARED MOTORS
 AC MOTORS
 MICROSWITCHES
 RELAYS
 REED SWITCHES
 SOLENOIDS A.C. or D.C.
 PROGRAMME TIMERS

C.F. BLOWERS
 AC CAPACITORS
 STROBE KITS
 FLASHTUBES
 CONTACTORS
 SYNCHRONOUS MOTORS

Phone in your enquiries

COMPRESSOR

Thomas single diaphragm. Max. 20 psi. 1 1/4" cfm., approx. 110V A.C., £16 + £2 p&p (total incl. VAT £20.70). OR, to include Transformer for 230/240V A.C. £26.45 incl. VAT.

VORTEX BLOWER & SUCTION UNIT

Powerful multi-stage dynamically balanced, totally enclosed, 9" dia. Rotators. 3500 rpm. 1 1/2" I.D. Inlet and outlet. 110V A.C. Price £20.00. Suitable transformer for 240V A.C. £5.00 + £3.00 p&p (total incl. VAT £32.20)

INSULATION TESTERS NEW

500 VOLTS 500 megohms £49 p&p £2. (£58.65 inc. VAT & p&p).
 1000 VOLTS 1000V 555 p&p £2 (£65.55 inc. VAT & p&p). SAE for leaflet.

SANGAMO WESTON TIME SWITCH

Type S251 200/250 AC 2 on/2 off every 24 hours. 20 amps contacts with override switch. Diameter 4" x 3", price £9.50 + £1.50 p&p (£12.65 inc. VAT & p&p). Also available with solar dia. R&T.
 Also available Sangamo Weston 60 amp and AEG 80 amp. Phone for details.
 Type S288 1 on, or 1 timed c/o every 24 hours, day omitting device. Price £11 + £1 p&p (£13.80 incl. VAT). N.M.S.
 Type S388. As above, plus 36 hours spring reserve. Less perspex cover. Price: £13 + £1 p&p (£16.10 incl. VAT). N.M.S.

COOLING or EXTRACTOR FAN

Quiet smooth-running. Size: 4 3/4x4 3/4" 1/2". Supplied for 240V A.C. operation. Price £4.75 + £1 p&p (total incl. VAT £6.52).

FROM STOCK AT PRICES THAT DEFY COMPETITION!

Stockists for Finnigans Hammerite paint and Waxoyl products

INSULATION TESTERS NEW

N.M.S. - New Manufacturers' Surplus.
 R&T - Reconditioned and Tested.

SERVICE TRADING CO

Ample parking space
 Showroom open Monday-Friday

57 BRIDGMAN ROAD, CHISWICK, LONDON W4 5BB, 01-995 1560
 ACCOUNT CUSTOMERS MIN. ORDER £10

Personal callers only. Open Saturdays
 9 Little Newport Street
 London WC2H 7JJ
 Tel: 01-437 0576

WW-035 FOR FURTHER DETAILS

LOW COST PROFESSIONAL TEST INSTRUMENTS

Write or phone for illustrated Test Instrument catalogue and price list.

★ FREQUENCY COUNTERS
 ★ ANALOGUE METERS
 ★ DIGITAL METERS
 ★ FUNCTION GEN
 ★ OSCILLOSCOPES
 ★ POWER SUPPLIES
 ★ LOGIC PROBE
 ★ SCOPE PROBES

BLACK STAR LTD.
 9A, Crown Street, St. Ives,
 Huntingdon, Cambs. PE17 4EB.
 Tel: (0480) 62440 Telex: 32339

WW - 008 FOR FURTHER DETAILS

ELECTRONIC SOFTWARE LINEAR CIRCUIT ANALYSIS

An all-machine code program for the rapid analysis of linear electronic circuits that may contain active and/or passive components. Capacity 20 nodes, 40 passive components, 10 active sources. Components may be R, L, C, transformer, transmission line, transistor, FET, Op-amp, etc. Handles complex source and load impedances and complex active sources. Simple rapid component or parameter value changes. Draws graphs with LOG/LIN/DB scales as required. Hardcopy of all results.
 For PET/CBM 3000/4000/8000 series ONLY. State model, tape, disc. Price £120 inclusive (no V.A.T.).
 The following programs are written in Basic and are available for CBM/BBC/Apple.
 Price £40 each inclusive (no V.A.T.). State model, disc or tape.
 VHF/UHF AMPLIFIER DESIGN: S parameters, stripline or discrete
 TRANSISTOR PARAMETER CONVERSIONS: S, h, z to y, any configuration
 DESIGN OF ACTIVE FILTERS: Butterworth, Chebychev, any no. of poles
 DESIGN OF LOSSLESS MATCHING NETWORKS: Complex to resistive
 Full details on request
 S. J. BRANSON, 111 PARK ROAD, PETERBOROUGH - Tel: 0733 67804

WW-063 FOR FURTHER DETAILS

Modem Kit Only £39.95

★ CCITT standard
 ★ 300 baud full duplex
 ★ Direct connection - greatly reduces data loss associated with acoustic couplers
 ★ Powered from phone lines therefore no power supply required
 ★ Opto coupled data in and data out for intrinsically safe operation.

Build it yourself for £39.95 including VAT and postage (note - case not included).

Racom Ltd., Dept. B
 81 Cholmeley Road, Reading, Berks RG1 3LY
 Tel: 0734 67027

WW - 049 FOR FURTHER DETAILS

SAMSONS

(ELECTRONICS) LTD.
9-10 Chapel Street, Marylebone
London NW1 5DN
21-23 Bell Street, London, NW1
01-262 5125 & 01-723 7851

MUFFIN FANS
SPECIAL OFFER!!!
240V fans
4 1/2x2 1/2x1 1/8" £5.75
inc. VAT + postage.
1 1/2" fans
4 1/2x2 1/2x1 1/8" £4.75
inc. VAT + postage.
Radiospares price
£14.50!!!

SPECIAL OFFER:
HIGH POWER AMPLIFIER TRANSFORMERS
Pri tapped 120-240V sec tapped 34-29-0-29-34V 6amps and 46V 1A. Open frame type. Tag connection. Size 5x4 1/2x4ins. £9 inc. postage and VAT.

SPECIAL OFFER HEAVY DUTY TRANSFORMERS
Pri 240V sec 50V 15 Amps. Twice will give 100V CT or 50V 30A. Open frame type. Terminal block primary. Sec heavy wire leads. Frame size 8 1/2x7x5 inches. Screen winding between pri and sec. Brand new, fraction of list price, £32, carr. £5, VAT £5.55.

BLOCK PAPER CAPACITORS
8 MFD 1000V DC WKG. £3. P&P £1. 8 MFD 350V DC WKG. £1. P&P 50p. 6 MFD 350V DC WKG. £7.5p. P&P 25p. 6 MFD 300V AC WKG. £1.50. P&P 50p. 4 MFD 350V DC WKG. 50p. P&P 25p. 1 MFD 350V DC WKG. 40p. P&P 20p. 1 MFD 1000V DC WKG. 50p. P&P 20p.

H.T. TRANSFORMERS
All are Parmeko potted style. All prices include VAT & carr.
No. 1. PRI 110V 220V 240V SEC. 350-325-0-325-350V 120 M/A £8.75
No. 2. PRI 110V 220V 240V. SEC. 400-0-400V 180M/A £8.75

HIGH GRADE LT TRANSFORMERS
ALL PRIMARIES 240V
OPEN FRAME TOP PANEL CONNECTIONS
No. 1 tapped 2-3-4-5-7-8-9-10-11-12-13-14-15-16-17-18-19-20-21-22-23-24-25-26-27-28-29-30-31-32-33-34-35-36-37-38-39-40-41-42-43-44-45-46-47-48-49-50-51-52-53-54-55-56-57-58-59-60-61-62-63-64-65-66-67-68-69-70-71-72-73-74-75-76-77-78-79-80-81-82-83-84-85-86-87-88-89-90-91-92-93-94-95-96-97-98-99-100-101-102-103-104-105-106-107-108-109-110-111-112-113-114-115-116-117-118-119-120-121-122-123-124-125-126-127-128-129-130-131-132-133-134-135-136-137-138-139-140-141-142-143-144-145-146-147-148-149-150-151-152-153-154-155-156-157-158-159-160-161-162-163-164-165-166-167-168-169-170-171-172-173-174-175-176-177-178-179-180-181-182-183-184-185-186-187-188-189-190-191-192-193-194-195-196-197-198-199-200-201-202-203-204-205-206-207-208-209-210-211-212-213-214-215-216-217-218-219-220-221-222-223-224-225-226-227-228-229-230-231-232-233-234-235-236-237-238-239-240-241-242-243-244-245-246-247-248-249-250-251-252-253-254-255-256-257-258-259-260-261-262-263-264-265-266-267-268-269-270-271-272-273-274-275-276-277-278-279-280-281-282-283-284-285-286-287-288-289-290-291-292-293-294-295-296-297-298-299-300-301-302-303-304-305-306-307-308-309-310-311-312-313-314-315-316-317-318-319-320-321-322-323-324-325-326-327-328-329-330-331-332-333-334-335-336-337-338-339-340-341-342-343-344-345-346-347-348-349-350-351-352-353-354-355-356-357-358-359-360-361-362-363-364-365-366-367-368-369-370-371-372-373-374-375-376-377-378-379-380-381-382-383-384-385-386-387-388-389-390-391-392-393-394-395-396-397-398-399-400-401-402-403-404-405-406-407-408-409-410-411-412-413-414-415-416-417-418-419-420-421-422-423-424-425-426-427-428-429-430-431-432-433-434-435-436-437-438-439-440-441-442-443-444-445-446-447-448-449-450-451-452-453-454-455-456-457-458-459-460-461-462-463-464-465-466-467-468-469-470-471-472-473-474-475-476-477-478-479-480-481-482-483-484-485-486-487-488-489-490-491-492-493-494-495-496-497-498-499-500-501-502-503-504-505-506-507-508-509-510-511-512-513-514-515-516-517-518-519-520-521-522-523-524-525-526-527-528-529-530-531-532-533-534-535-536-537-538-539-540-541-542-543-544-545-546-547-548-549-550-551-552-553-554-555-556-557-558-559-560-561-562-563-564-565-566-567-568-569-570-571-572-573-574-575-576-577-578-579-580-581-582-583-584-585-586-587-588-589-590-591-592-593-594-595-596-597-598-599-600-601-602-603-604-605-606-607-608-609-610-611-612-613-614-615-616-617-618-619-620-621-622-623-624-625-626-627-628-629-630-631-632-633-634-635-636-637-638-639-640-641-642-643-644-645-646-647-648-649-650-651-652-653-654-655-656-657-658-659-660-661-662-663-664-665-666-667-668-669-670-671-672-673-674-675-676-677-678-679-680-681-682-683-684-685-686-687-688-689-690-691-692-693-694-695-696-697-698-699-700-701-702-703-704-705-706-707-708-709-710-711-712-713-714-715-716-717-718-719-720-721-722-723-724-725-726-727-728-729-730-731-732-733-734-735-736-737-738-739-740-741-742-743-744-745-746-747-748-749-750-751-752-753-754-755-756-757-758-759-760-761-762-763-764-765-766-767-768-769-770-771-772-773-774-775-776-777-778-779-780-781-782-783-784-785-786-787-788-789-790-791-792-793-794-795-796-797-798-799-800-801-802-803-804-805-806-807-808-809-810-811-812-813-814-815-816-817-818-819-820-821-822-823-824-825-826-827-828-829-830-831-832-833-834-835-836-837-838-839-840-841-842-843-844-845-846-847-848-849-850-851-852-853-854-855-856-857-858-859-860-861-862-863-864-865-866-867-868-869-870-871-872-873-874-875-876-877-878-879-880-881-882-883-884-885-886-887-888-889-890-891-892-893-894-895-896-897-898-899-900-901-902-903-904-905-906-907-908-909-910-911-912-913-914-915-916-917-918-919-920-921-922-923-924-925-926-927-928-929-930-931-932-933-934-935-936-937-938-939-940-941-942-943-944-945-946-947-948-949-950-951-952-953-954-955-956-957-958-959-960-961-962-963-964-965-966-967-968-969-970-971-972-973-974-975-976-977-978-979-980-981-982-983-984-985-986-987-988-989-990-991-992-993-994-995-996-997-998-999-1000-1001-1002-1003-1004-1005-1006-1007-1008-1009-1010-1011-1012-1013-1014-1015-1016-1017-1018-1019-1020-1021-1022-1023-1024-1025-1026-1027-1028-1029-1030-1031-1032-1033-1034-1035-1036-1037-1038-1039-1040-1041-1042-1043-1044-1045-1046-1047-1048-1049-1050-1051-1052-1053-1054-1055-1056-1057-1058-1059-1060-1061-1062-1063-1064-1065-1066-1067-1068-1069-1070-1071-1072-1073-1074-1075-1076-1077-1078-1079-1080-1081-1082-1083-1084-1085-1086-1087-1088-1089-1090-1091-1092-1093-1094-1095-1096-1097-1098-1099-1100-1101-1102-1103-1104-1105-1106-1107-1108-1109-1110-1111-1112-1113-1114-1115-1116-1117-1118-1119-1120-1121-1122-1123-1124-1125-1126-1127-1128-1129-1130-1131-1132-1133-1134-1135-1136-1137-1138-1139-1140-1141-1142-1143-1144-1145-1146-1147-1148-1149-1150-1151-1152-1153-1154-1155-1156-1157-1158-1159-1160-1161-1162-1163-1164-1165-1166-1167-1168-1169-1170-1171-1172-1173-1174-1175-1176-1177-1178-1179-1180-1181-1182-1183-1184-1185-1186-1187-1188-1189-1190-1191-1192-1193-1194-1195-1196-1197-1198-1199-1200-1201-1202-1203-1204-1205-1206-1207-1208-1209-1210-1211-1212-1213-1214-1215-1216-1217-1218-1219-1220-1221-1222-1223-1224-1225-1226-1227-1228-1229-1230-1231-1232-1233-1234-1235-1236-1237-1238-1239-1240-1241-1242-1243-1244-1245-1246-1247-1248-1249-1250-1251-1252-1253-1254-1255-1256-1257-1258-1259-1260-1261-1262-1263-1264-1265-1266-1267-1268-1269-1270-1271-1272-1273-1274-1275-1276-1277-1278-1279-1280-1281-1282-1283-1284-1285-1286-1287-1288-1289-1290-1291-1292-1293-1294-1295-1296-1297-1298-1299-1300-1301-1302-1303-1304-1305-1306-1307-1308-1309-1310-1311-1312-1313-1314-1315-1316-1317-1318-1319-1320-1321-1322-1323-1324-1325-1326-1327-1328-1329-1330-1331-1332-1333-1334-1335-1336-1337-1338-1339-1340-1341-1342-1343-1344-1345-1346-1347-1348-1349-1350-1351-1352-1353-1354-1355-1356-1357-1358-1359-1360-1361-1362-1363-1364-1365-1366-1367-1368-1369-1370-1371-1372-1373-1374-1375-1376-1377-1378-1379-1380-1381-1382-1383-1384-1385-1386-1387-1388-1389-1390-1391-1392-1393-1394-1395-1396-1397-1398-1399-1400-1401-1402-1403-1404-1405-1406-1407-1408-1409-1410-1411-1412-1413-1414-1415-1416-1417-1418-1419-1420-1421-1422-1423-1424-1425-1426-1427-1428-1429-1430-1431-1432-1433-1434-1435-1436-1437-1438-1439-1440-1441-1442-1443-1444-1445-1446-1447-1448-1449-1450-1451-1452-1453-1454-1455-1456-1457-1458-1459-1460-1461-1462-1463-1464-1465-1466-1467-1468-1469-1470-1471-1472-1473-1474-1475-1476-1477-1478-1479-1480-1481-1482-1483-1484-1485-1486-1487-1488-1489-1490-1491-1492-1493-1494-1495-1496-1497-1498-1499-1500-1501-1502-1503-1504-1505-1506-1507-1508-1509-1510-1511-1512-1513-1514-1515-1516-1517-1518-1519-1520-1521-1522-1523-1524-1525-1526-1527-1528-1529-1530-1531-1532-1533-1534-1535-1536-1537-1538-1539-1540-1541-1542-1543-1544-1545-1546-1547-1548-1549-1550-1551-1552-1553-1554-1555-1556-1557-1558-1559-1560-1561-1562-1563-1564-1565-1566-1567-1568-1569-1570-1571-1572-1573-1574-1575-1576-1577-1578-1579-1580-1581-1582-1583-1584-1585-1586-1587-1588-1589-1590-1591-1592-1593-1594-1595-1596-1597-1598-1599-1600-1601-1602-1603-1604-1605-1606-1607-1608-1609-1610-1611-1612-1613-1614-1615-1616-1617-1618-1619-1620-1621-1622-1623-1624-1625-1626-1627-1628-1629-1630-1631-1632-1633-1634-1635-1636-1637-1638-1639-1640-1641-1642-1643-1644-1645-1646-1647-1648-1649-1650-1651-1652-1653-1654-1655-1656-1657-1658-1659-1660-1661-1662-1663-1664-1665-1666-1667-1668-1669-1670-1671-1672-1673-1674-1675-1676-1677-1678-1679-1680-1681-1682-1683-1684-1685-1686-1687-1688-1689-1690-1691-1692-1693-1694-1695-1696-1697-1698-1699-1700-1701-1702-1703-1704-1705-1706-1707-1708-1709-1710-1711-1712-1713-1714-1715-1716-1717-1718-1719-1720-1721-1722-1723-1724-1725-1726-1727-1728-1729-1730-1731-1732-1733-1734-1735-1736-1737-1738-1739-1740-1741-1742-1743-1744-1745-1746-1747-1748-1749-1750-1751-1752-1753-1754-1755-1756-1757-1758-1759-1760-1761-1762-1763-1764-1765-1766-1767-1768-1769-1770-1771-1772-1773-1774-1775-1776-1777-1778-1779-1780-1781-1782-1783-1784-1785-1786-1787-1788-1789-1790-1791-1792-1793-1794-1795-1796-1797-1798-1799-1800-1801-1802-1803-1804-1805-1806-1807-1808-1809-1810-1811-1812-1813-1814-1815-1816-1817-1818-1819-1820-1821-1822-1823-1824-1825-1826-1827-1828-1829-1830-1831-1832-1833-1834-1835-1836-1837-1838-1839-1840-1841-1842-1843-1844-1845-1846-1847-1848-1849-1850-1851-1852-1853-1854-1855-1856-1857-1858-1859-1860-1861-1862-1863-1864-1865-1866-1867-1868-1869-1870-1871-1872-1873-1874-1875-1876-1877-1878-1879-1880-1881-1882-1883-1884-1885-1886-1887-1888-1889-1890-1891-1892-1893-1894-1895-1896-1897-1898-1899-1900-1901-1902-1903-1904-1905-1906-1907-1908-1909-1910-1911-1912-1913-1914-1915-1916-1917-1918-1919-1920-1921-1922-1923-1924-1925-1926-1927-1928-1929-1930-1931-1932-1933-1934-1935-1936-1937-1938-1939-1940-1941-1942-1943-1944-1945-1946-1947-1948-1949-1950-1951-1952-1953-1954-1955-1956-1957-1958-1959-1960-1961-1962-1963-1964-1965-1966-1967-1968-1969-1970-1971-1972-1973-1974-1975-1976-1977-1978-1979-1980-1981-1982-1983-1984-1985-1986-1987-1988-1989-1990-1991-1992-1993-1994-1995-1996-1997-1998-1999-2000-2001-2002-2003-2004-2005-2006-2007-2008-2009-2010-2011-2012-2013-2014-2015-2016-2017-2018-2019-2020-2021-2022-2023-2024-2025-2026-2027-2028-2029-2030-2031-2032-2033-2034-2035-2036-2037-2038-2039-2040-2041-2042-2043-2044-2045-2046-2047-2048-2049-2050-2051-2052-2053-2054-2055-2056-2057-2058-2059-2060-2061-2062-2063-2064-2065-2066-2067-2068-2069-2070-2071-2072-2073-2074-2075-2076-2077-2078-2079-2080-2081-2082-2083-2084-2085-2086-2087-2088-2089-2090-2091-2092-2093-2094-2095-2096-2097-2098-2099-2100-2101-2102-2103-2104-2105-2106-2107-2108-2109-2110-2111-2112-2113-2114-2115-2116-2117-2118-2119-2120-2121-2122-2123-2124-2125-2126-2127-2128-2129-2130-2131-2132-2133-2134-2135-2136-2137-2138-2139-2140-2141-2142-2143-2144-2145-2146-2147-2148-2149-2150-2151-2152-2153-2154-2155-2156-2157-2158-2159-2160-2161-2162-2163-2164-2165-2166-2167-2168-2169-2170-2171-2172-2173-2174-2175-2176-2177-2178-2179-2180-2181-2182-2183-2184-2185-2186-2187-2188-2189-2190-2191-2192-2193-2194-2195-2196-2197-2198-2199-2200-2201-2202-2203-2204-2205-2206-2207-2208-2209-2210-2211-2212-2213-2214-2215-2216-2217-2218-2219-2220-2221-2222-2223-2224-2225-2226-2227-2228-2229-2230-2231-2232-2233-2234-2235-2236-2237-2238-2239-2240-2241-2242-2243-2244-2245-2246-2247-2248-2249-2250-2251-2252-2253-2254-2255-2256-2257-2258-2259-2260-2261-2262-2263-2264-2265-2266-2267-2268-2269-2270-2271-2272-2273-2274-2275-2276-2277-2278-2279-2280-2281-2282-2283-2284-2285-2286-2287-2288-2289-2290-2291-2292-2293-2294-2295-2296-2297-2298-2299-2300-2301-2302-2303-2304-2305-2306-2307-2308-2309-2310-2311-2312-2313-2314-2315-2316-2317-2318-2319-2320-2321-2322-2323-2324-2325-2326-2327-2328-2329-2330-2331-2332-2333-2334-2335-2336-2337-2338-2339-2340-2341-2342-2343-2344-2345-2346-2347-2348-2349-2350-2351-2352-2353-2354-2355-2356-2357-2358-2359-2360-2361-2362-2363-2364-2365-2366-2367-2368-2369-2370-2371-2372-2373-2374-2375-2376-2377-2378-2379-2380-2381-2382-2383-2384-2385-2386-2387-2388-2389-2390-2391-2392-2393-2394-2395-2396-2397-2398-2399-2400-2401-2402-2403-2404-2405-2406-2407-2408-2409-2410-2411-2412-2413-2414-2415-2416-2417-2418-2419-2420-2421-2422-2423-2424-2425-2426-2427-2428-2429-2430-2431-2432-2433-2434-2435-2436-2437-2438-2439-2440-2441-2442-2443-2444-2445-2446-2447-2448-2449-2450-2451-2452-2453-2454-2455-2456-2457-2458-2459-2460-2461-2462-2463-2464-2465-2466-2467-2468-2469-2470-2471-2472-2473-2474-2475-2476-2477-2478-2479-2480-2481-2482-2483-2484-2485-2486-2487-2488-2489-2490-2491-2492-2493-2494-2495-2496-2497-2498-2499-2500-2501-2502-2503-

Appointments

Advertisements accepted up to 12 noon Tuesday, August 2nd, for September issue, subject to space available.

DISPLAYED APPOINTMENTS VACANT: £17 per single col. centimetre (min. 3cm).
LINE advertisements (run on): £3.50 per line, minimum £25 (prepayable).
BOX NUMBERS: £5 extra. (Replies should be addressed to the Box Number in the advertisement, c/o Quadrant House, The Quadrant, Sutton, Surrey SM2 5AS).
PHONE: IAN FAUX, 01-661 3033 (DIRECT LINE)

Cheques and Postal Orders payable to BUSINESS PRESS INTERNATIONAL LTD. and crossed.



ALWAYS AHEAD WITH THE BEST!

£5,000-£18,000

- ★ **Where does your interest lie:** Communications; Computers; Weapons; Radar; Sonar; Data-Comms; Signal Processing; Medical; Telemetry; Simulation; Satcom; Local Area Nets; ATE?
- ★ **Experienced in:** Mini/Microprocessor Hardware or Software; Digital and Analogue circuitry; RF and Microwave techniques?
- ★ **There are opportunities in:** Design; Test; Sales and Service for Engineers and Managers.
- ★ **Act now:** Just dial 100 and ask for FREEFONE JOBLINE or send your c.v. to:

ELECTRONIC COMPUTER AND MANAGEMENT APPOINTMENTS LIMITED
 Freepost, Barkway, Royston, Herts SG8 8BR

(1926)

Metropolitan Police Office

Telecommunication Officer

The Command and Control Computer System provides the Metropolitan Police with a message switching system and is used for the efficient handling of emergency calls and the use of Police resources.

The successful candidate will control and co-ordinate the activities of the shift computer and network operation personnel; control and direct the operations shift support officer with particular regard to recovery and back-up procedures and services to the Force Training School at Hendon; correlate system performance data and prepare computer systems performance reports, including recommendation for action to improve system performance.

Candidates must have TEC Higher or SCOTEC Higher Certificate in Electronics, Telecommunications or similar discipline: OR C&G Full Technological Technicians Certificates Parts I, II and III in Telecommunications; OR HNC in Electrical/Electronic Engineering; OR an equivalent or higher acceptable qualification. All candidates must have had appropriate training and should normally have 10 years experience of computer operations and telecommunications. Knowledge of Sperry Univac 1100 series machines advantageous. Senior ex-service personnel with TEC/SCOTEC/C&G recognised exemptions will also be considered.

Starting salary £9340 rising to £10800. In addition this post attracts £1250 Inner London Weighting. Promotion prospects.

RELOCATION ASSISTANCE MAY BE AVAILABLE.

For further details and an application form (to be returned by 12 August 1983) write to Civil Service Commission, Alencon Link, Basingstoke, Hants, RG21 1JB, or telephone Basingstoke (0256) 68551 (answering service operates outside office hours). Please quote ref: T/6012.

SEVERN TRENT WATER AUTHORITY

Senior Communications Engineer

£9,033-£9,999 p.a.

Communications Engineer

£8,154-£9,033 p.a.

The Authority is currently installing a regional network of microwave radio links to connect principal offices throughout its area. The network, which consists primarily of 1.5 GHz links, is used for both speech and data and is due for completion in August of this year.

The successful candidates should be qualified to HND/HNC level in Electronics/Electrical and are required to maintain and enhance radio, multiplex and other ancillary and terminal equipment associated with the system. Experience in the installation, commissioning and maintenance of a broad variety of electronic and electrical equipment is necessary. Both post holders will be required to undertake certain emergency repair duties outside normal office hours.

While the two posts are based in Finham on the southern outskirts of Coventry in the Avon Division both engineers will however, in the course of their duties, be required to travel extensively throughout the Authority's Region.

Application forms are available from the Personnel Office, Severn Trent Water Authority, Avon Division, Avon House, De-Montfort Way, Cannon Park, Coventry CV4 7EJ. Telephone: Coventry (0203) 416510.

Closing date for the return of application forms: 3 August, 1983.

(2199)

SEVERN TRENT WATER

WIRELESS WORLD AUGUST 1983

Electronic Test Engineers/Technicians

Racal Radar Defence Systems part of the Racal Electronics Group is undergoing a period of rapid growth. To meet our increasing production demands, we need to recruit a number of Test Technicians and Test Engineers at the following locations in Surrey - New Malden, Chessington and Hersham, and at Leicester.

The Company manufactures a wide range of products aimed principally at the Defence Industry including radar early warning and guidance systems, military displays and ECM and ESM systems.

The Test Department is responsible for the test and diagnostic functions on a wide range of complex radar equipment using high quality manual and automatic test equipment.

Applicants should be educated to HNC/HTC standard and have practical knowledge or experience of radar and/or microwave systems.

Conditions of employment are excellent including a competitive salary, five weeks holiday, and company pension and life assurance scheme.

Interested? Then phone me on: 01-397 5281 or alternatively write with brief details of qualification experience and current salary to:

Mr P N Willis,
 Senior Personnel Officer,
 Racal Radar Defence Systems Ltd.,
 Davis Road, Chessington, Surrey.

Racal's people are Racal's success



(2188)

FIELD SERVICE ENGINEER

LKB Instruments Limited, the UK subsidiary of a major international scientific instrument company is further expanding its range of products for the diagnostic clinical chemistry market and as a result a vacancy exists for a Field Service Engineer within their Customer Service Department.

Applicants should have a sound knowledge of digital and analogue electronics, and field service experience in clinical or medical instrumental diagnostics would be a distinct advantage.

The work involves the repair and maintenance of instrumentation situated mainly in Hospitals and University Laboratories. Preference will be given to applicants living in the London area.

Conditions of employment are excellent and in addition to a good basic salary and company car, the company has a profit-sharing scheme, BUPA participation and four weeks' annual holiday.

Contact Mrs. D. Duff, for Application Form

LKB INSTRUMENTS LIMITED
 232 Addington Road, Selsdon
 South Croydon, Surrey CR2 8YD

Tel: 01-651 5313

(2184)

RF SERVICE ENGINEER

We are responsible for all aspects of sales, service and warranty in Europe for the Plasma Therm range of RF generators, plasma processing equipment and inductively coupled plasma systems throughout UK, Europe and Scandinavia. The Plasma Therm product range is a market leader in its field and has an enviable track record of profitable growth and product innovation.

THE JOB. RF service engineer based in London to provide RF service and technical support throughout UK, Europe and Scandinavia. The candidate should be a self starter, willing and able to work on his own, and be able to trouble-shoot and solve problems in the field.

REMUNERATION. The right candidate will be offered an attractive financial package to include a performance-related bonus scheme, pension and a company car.

Applications and cvs should be addressed to:

Mr J. F. Stackhouse
 PLASMA THERM LTD.
 Kangley Bridge Road, Sydenham
 London SE26 5AR

(2156)

CUT THIS OUT!

Clip this advert and you can stop hunting for your next appointment. We have a wide selection of the best appointments in Digital, Analogue, RF, Microwave, Micro-processor, Computer, Data Comms and Medical Electronics and we're here to serve *your* interests. Call us now for posts in Design, Sales, Applications or Field Service, at all levels from £6,000-£16,000.



11 Westbourne Grove, London W2. Tel: 01-229 9239.

1935

Akai (UK) Limited, a leading name in the consumer electronic market, specialising in hi-fi and video products, now have the following vacancies at their Heathrow headquarters:

VIDEO TECHNICIAN

As one of the leaders in the video market we are seeking a Video Technician, aged 25+ who is a fully qualified, experienced Television Engineer. Applicants will have some experience of repairing video recorders as this opportunity is in our busy in-house Servicing Department.

We work to high standards and need someone who will maintain them, as well as being self-motivated with the ability to handle technical queries both by telephone and letter.

SENIOR AUDIO TECHNICIAN

The successful candidate will be fully qualified with some years experience in the servicing and repair of high quality hi-fi equipment. This will suit someone who is looking for a more supervisory position where duties will include the control of a small workshop, answering technical queries and dealing with the public, in addition to normal servicing work.

Communication skills both written and oral are necessary, as is the ability to cope with the pressure in this highly active department.

AUDIO TECHNICIAN

Due to our ever increasing growth we now need another Audio Technician to join our servicing team. Applicants will be fully qualified and have some experience in the servicing and the repairing of high quality hi-fi equipment.

The above positions offer competitive, negotiable salaries on the basis of age and experience, an attractive benefits package and the opportunity of joining a Company that is progressive in its outlook.

Men and women interested should write or telephone for an application form to: (no agencies). (2208)

Pat Mann, AKAI (UK) Ltd., Haslemere Heathrow Estate, Parkway, Hounslow, Middlesex TW4 6NF. Telephone: 01-897 6388.



E.L.A.C. REQUIRE AN ACOUSTIC ENGINEER

Electro Acoustic Industries Limited, a progressive and expanding Company, require an enthusiastic Engineer to assist in the development of loudspeakers for all purposes, covering a range from specialist telecomm. applications HiFi, M.O.D. Marine to 'In Car' entertainment. The successful candidate will be aged between 25 and 35 years and have had some practical experience in the design and application of test equipment. Experience in the use of Bruel & Kjaer frequency measuring equipment is particularly relevant.

Write including a C.V. to: MR. R. N. WALTON TECHNICAL DIRECTOR ELECTRO ACOUSTIC INDUSTRIES LTD STAMFORD WORKS TOTTENHAM N15 4QU

(2181)

Test & Calibration Engineers

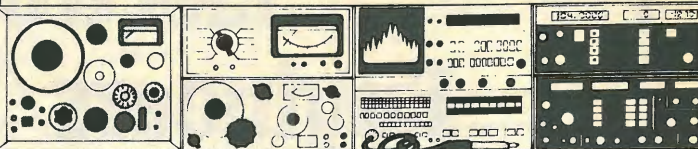

Having introduced an extended new product range, many of which are microprocessor based, Marconi Instruments has once again confirmed itself as Europe's leading manufacturer of sophisticated test and measurement systems. Our products are selling throughout the world and we are naturally developing further new and innovative designs.

A key role in our organisation is that of our Luton based Service Division, where a group of Technicians satisfy a very wide range of customer needs in the repair and calibration of test equipment.

When you join our team you will quickly become individually responsible for work assignments involving many different kinds of propriety products.

Prospects are excellent. The Division is part of a large company with its main Instrument Design/Manufacturing Base at St. Albans, a Microwave Plant at Stevenage and a further substantial Design Manufacturing Group at Donibristle in Scotland. The Company is proud of its policy of promoting men and women from within, as future Salesmen, Managers and Engineers.

Salaries, which are dependent upon experience and ability are excellent and regular overtime is normally available. Progress for competent engineers and technicians can be rapid. Relocation assistance is available in approved cases. Special consideration is given to 'ex-forces' personnel.

Whatever your level of experience we would like to hear from you. Cut out the coupon and send it to John Prodger, Recruitment Manager, Marconi Instruments Limited, FREEPOST, St. Albans AL4 0BR. Tel: (0727) 59292.

Name	Age			
Address				
Tel. No.				
Years Experience				
Present Salary:	£6,000	£7,000	£8,000	Over
	<input type="checkbox"/>	<input type="checkbox"/>	<input type="checkbox"/>	<input type="checkbox"/>
	£7,000	£8,000	£9,000	£9,000
Qualifications				
Present Job				

(2143)



CHELSEA COLLEGE University of London

Applications are invited for the post of

TECHNICIAN GRADE 5

to join an Electronic/Development Workshop working with the departments of basic medical sciences. The work undertaken consists of the design, development and construction of analog and digital equipment for use in the life sciences. The successful applicant will have a good knowledge of electronics and an interest in or experience of the application of these techniques to solving biological problems.

Salary scale: £6279 - £7332 pa plus £1220 London Allowance.

Application forms from the Personnel Office, Chelsea College, 552 King's Road, London SW10 0UA. Closing date: 3rd August 1983. (2192)

CHIEF ELECTRONICS TECHNICIAN

DARTFORD and GRAVESHAM HEALTH AUTHORITY based at JOYCE GREEN HOSPITAL, DARTFORD, KENT

Qualifications - ONC, HNC preferred. Salary Scale - £7,386 to £9,212 Medical Physics Technician II This is a newly established post offering an exceptional opportunity for the establishment of a section responsible for the maintenance of electronic and bio-medical equipment.

Candidates, male or female, should possess broad experience of electronics together with an understanding of the safety aspects of equipment.

In addition to a sound technical background applicants should possess the managerial qualities required to organise and supervise both subordinate staff and contracted work and be capable of developing and sustaining successful working relationships with all levels and disciplines of hospital staff.

For job description and application form write to: District Personnel Dept., Darenth Park Hospital, Dartford, Kent. PREVIOUS APPLICANTS FOR THIS POST WILL BE CONSIDERED AND NEED NOT RE-APPLY. (2195)

LEEDS WESTERN HEALTH AUTHORITY THE GENERAL INFIRMARY AT LEEDS

MEDICAL PHYSICS TECHNICIAN

GRADE III or IV (Electronics)

Electronics Technician required in the Medical Physics Department. Duties of the post include the development, commissioning, testing, maintenance and repair of a variety of electro-medical and computing equipment. The post becomes available on 1st November, 1983.

Experience in electronics is essential and the appointment will be made in Grade III or IV depending on the qualifications and experience of the successful candidate. Salary will be in the range £6132 to £7926 (Grade III) or £5171 to £6798 (Grade IV).

Application forms and job descriptions are obtainable from The Personnel Officer, Leeds General Infirmary, Great George Street, Leeds LS1 3EX.

Closing date: 29th July, 1983. (2209)

LOGEX ELECTRONICS RECRUITMENT

Specialists in Field & Customer Engineering appointments, all locations and disciplines.

Logex House, Burleigh, Stroud Gloucestershire GL5 2PW 0453 883264 & 01-290 0267 (24 hours)

R & D OPPORTUNITIES. Senior level vacancies for Communications Hardware and Software Engineers, based in West Sussex. Competitive salaries offered. Please ring David Bird at Rediffusion Radio Systems on 01-874 7281. (1162)

RF ENGINEER

TO CARE ABOUT A PRODUCT THAT CARES FOR THE USER

YORKSHIRE

£11,000

Our client, Tunstall Telecom, designs and manufactures the UK's most used emergency communications system for the elderly or infirm.

The increasing demand for greater flexibility and mobility of use has created the need for a further RF Engineer.

The work will be on varied low power RF frequency projects and will involve significant theoretical and practical design.

You will work in co-operation with other areas of R & D and part of the task will be to liaise with the Home Office.

The position will suit someone with proven design experience from a commercial background, a degree and most of all a mature approach to cost effective and 'producible' design work.

Apart from an excellent negotiable salary and benefits package (with relocation assistance where necessary) this is an opportunity to make a very personal 'stamp' on a product that will have a very beneficial effect on the elderly and infirm within the country.

To discuss this position in greater detail telephone or write to Paul Hecquet on Lewes (07916) 71271.

(2174)

Electronic Engineers - What you want, where you want!

TJB Electrotechnical Personnel Services is a specialised appointments service for electrical and electronic engineers. We have clients throughout the UK who urgently need technical staff at all levels from Junior Technician to Senior Management. Vacancies exist in all branches of electronics and allied disciplines - right through from design to marketing - at salary levels from around £5000-£15000

If you wish to make the most of your qualifications and experience and move another rung or two up the ladder we will be pleased to help you. All applications are treated in strict confidence and there is no danger of your present employer (or other companies you specify) being made aware of your application.

TJB ELECTROTECHNICAL PERSONNEL SERVICES, 12 Mount Ephraim, Tunbridge Wells, Kent. TN4 8AS.

Tel: 0892 39388



Please send me a TJB Appointments Registration form:

Name

Address

(861)

Premier international electronics companies – very secure and expanding in London and the south of England – require professional senior staff (including departmental heads). Relocation allowance up to £3,000.

ELECTRONIC ENGINEERS

Electronic engineers required with degree – H.N.C. – tech. cert. – O.N.C. Almost any background required but software and hardware experience will bring salary of absolute minimum of £6,500 p.a. and could be up to £11,000 p.a.

ELECTRONIC DESIGN/DEVELOPMENT

Engineers required with experience of circuit or component design or development for microwave equipment or digital logic or computer peripherals or electronic packaging or film technology or telecommunications. Also above for updating in modern techniques. Salaries up to £15,000.

SOFTWARE PROGRAMMERS & ENGINEERS

Engineers or mathematicians required for development of commissioning and design proving programmes from assistant to team leader level. Salaries up to £12,000 p.a.

Please contact by telephone, or letter, to discuss companies and possibilities. Watford 49456 anytime.

(2146)

GORE MANAGEMENT SERVICES LTD

SELECTION & TRAINING CONSULTANTS
218 St Albans Road, Watford, Herts.
Tel: Watford 49456

B&W

LOUDSPEAKER ENGINEER

Rare opportunity to join the R&D team at B&W Loudspeakers in Sussex

The successful candidate will be involved with the design and development of both loudspeaker drive units and complete high-fidelity speaker systems, using our in-house computer and laser interferometer.

Applicants should be educated to at least HNC standard and preferably have experience of electronics and acoustics. A thorough understanding of the operation of a loudspeaker system is essential.

The salary is negotiable. Please apply in writing to Stephen Roe.

B&W LOUDSPEAKERS LTD
Elm Grove Lane, Steyning, West Sussex (2207)

Royal Marsden Hospital, Fullham Road, London SW3 Medical Physics Technician MPT2

required in the Physics and Radiotherapy Departments. The appointed person will be responsible for the supervision of a pleasantly situated, well-equipped electronics workshop and the maintenance and service of an interesting variety of radiotherapy equipment.

The Department has 3 cobalt treatment machines, 150kv and 300kv X-ray units, a Philips 10mv linear accelerator and a simulator. Current developments include the installation of a Philips 5mv linear accelerator and caesium Selectron unit.

Applicants should hold ONC, HNC or similar qualification in electrical engineering or (preferably) in electronics, and have relevant technical experience particularly with Philips linear accelerators. To be appointed on to the MPT2 scale applicants should have served at least 2 years as MPT3 or equivalent. Salary scale £8,383-£10,209 per annum.

Application form and job description available from the Personnel Department, Royal Marsden Hospital, at the above address. Tel: 01-352 8171 Ext. 446/447. (2197)

CAMBRIDGE HEALTH AUTHORITY Physics Department Addenbrooke's Hospital, Hills Road, Cambridge

Medical Physics Technician Grade II (£7,386-£9,212)

An electronics technician is required to provide maintenance and support services to the CT Head Scanner at Addenbrooke's Hospital and to electro-medical equipment in the Thoracic Surgical Unit, Papworth Hospital.

Applicants should hold an appropriate HNC or equivalent qualification and have several years' experience in the field of electronics (mini computer experience advantageous).

For further details contact Mr P. E. Ward, Principal Physics Technician, at the above address. Tel: (0223) 245151 ext. 471.

Application form and job description from the Personnel Department ext. 7511. (2177)

UNIVERSITY OF SURREY

Department of Electronic and Electrical Engineering

RESEARCH OFFICER for the "UOSAT Spacecraft project"

Applications are invited from engineers with proven experience in RF and/or digital techniques for the post of Research Officer on the UOSAT spacecraft project.

The work will involve the initiation, implementation and operation of spacecraft ground support hardware/software and the design and fabrication of future spacecraft systems.

The UOSAT spacecraft, built in the Department of Electronic & Electrical Engineering at the University of Surrey, supported by UK Industry (AMSAT-UK and the RSGB), and launched by NASA in October 1981, is controlled from a command station located within the Department. The spacecraft currently supports a number of engineering, scientific, educational and amateur radio experiments and is expected to continue operating for several years.

The appointment will be for 12 months on Research and Analogous Scales up to a maximum of £8530 per annum.

Applications in the form of a curriculum vitae (3 copies) including the names and addresses of two referees should be sent to the Deputy Secretary (Personnel), University of Surrey, Guildford, Surrey, GU2 5XH, by 22 August 1983 quoting reference 170/WW. (2173)

Test Engineers/ Technicians here's a package worth looking into

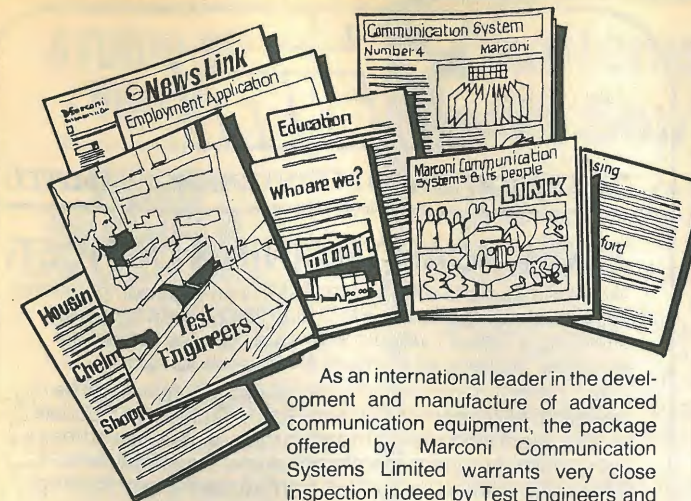

As an international leader in the development and manufacture of advanced communication equipment, the package offered by Marconi Communication Systems Limited warrants very close inspection indeed by Test Engineers and Technicians.

When you're thinking about a move, you've got to be sure that both your career and lifestyle are going to benefit. And we believe we have a lot to offer on both accounts.

Right now we are seeking men or women to join our Space and Microwave, Digital Communications and Defence Departments to work on a wide range of equipment including satellite and tropo systems, data modems, PCM and associated ATE such as Graduate.

Of our reputation in advanced electronics there can be little doubt. Current projects, like Triffid, ICS3 and Modems for

Marconi
Communication Systems

British Telecoms new data distribution service are among the most advanced of their kind, designed to meet the needs of military and civil communications for a generation to come.

In Chelmsford we're very conveniently located for London, the Essex countryside and coast. A modern town with good facilities and a variety of reasonably priced housing.

Applicants should preferably be qualified to HNC in Electronics although practical experience in a test or field services environment is equally important.

Vacancies cover a wide range of seniority and responsibility with salaries between £5,000 – £8,000 p.a. Our information package will tell you more so telephone now for your copy or write with full C/V to Gordon Short at Marconi Communication Systems Limited, New Street, Chelmsford, Essex, CM1 1PL. Tel. Chelmsford (0245) 353221, extension 592.



VHF/Radio Engineer

Middle East

Our client, involved in several major projects overseas, require a Telecommunications Engineer immediately to advise and monitor an important harbour system. Emphasis is on VHF radio links, operational control and port safety services.

Candidates should be graduates in an appropriate discipline, preferably with membership of a professional institution, and have relevant experience in VHF radio field. In addition to professional background, applicants must be skilled in liaison and consultancy practices, preferably gained overseas and be available for immediate interview and posting.

The post attracts an excellent tax-free salary package of

c.£24,000 together with usual overseas benefits, including free furnished accommodation, company car and medical cover. Candidates, aged 30-45, must hold relevant degree to qualify for interview.

Please write initially with full career details to Confidential Reply Service, Ref. DSV 8760, Austin Knight Limited, London, W1A 1DS.

Applications are forwarded to the client concerned, therefore companies in which you are not interested should be listed in a covering letter to the Confidential Reply Supervisor.

Austin Knight Advertising

BORED ?

Then change your job!

1) Film-TV Equipment
Installation and maintenance of studio and TV equipment. UK and abroad.

2) Satellite Communications
Test Engineers required with experience of digital circuitry. £7,700. Surrey.

3) Microcomputers and Peripherals
Service Engineers required £8-£10,000 Camberley.

4) Data Communications
Service of microprocessor-based equipment. £8,000 – car. Reading.

5) Service Personnel (RAF, RN, Army)
We have many clients interested in employing ex-service fitters and technicians at sites throughout the UK. Phone for details.

6) £500 per week
We are paying very high rates for contract design and test engineers who have a background in RF, MICROWAVE, DIGITAL ANALOGUE or SOFTWARE, at sites throughout the UK.

Hundreds of other Electronic and Computer Vacancies to £12,500

Phone or write:
Roger Howard, C.Eng.,
M.I.E.E., M.I.E.R.E.

CLIVEDEN CONSULTANTS
87 St. Leonard's Road, Windsor, Berks.
Windsor (07535) 58022 (5 lines)

(1640)

CLIVEDEN

BOX NOS.

Box number replies should be addressed to:

Box No.....
c/o Wireless World
Quadrant House
The Quadrant
Sutton, Surrey, SM2 5AS



require

A SAFETY/TECHNICAL CO-ORDINATOR

Pioneer High Fidelity (GB) Limited is a very successful and expanding company in the electronic consumer industry. We market a wide range of Hi Fi, Car Audio and Video products. A vacancy now exists in our Technical Department for a Safety/Technical Co-ordinator at our new premises in Greenford, Middlesex.

The job entails the submission of new products to B.E.A.B. for approval, liaising with our factories in Japan and with the United Kingdom Safety Authorities and the writing of technical service bulletins for our dealers and authorised service centres.

The successful applicant should be fully conversant with BS-415 safety standards, applicable to domestic electrical equipment, and should have had at least two years' experience in this field.

He/she should be qualified to H.N.C. or equivalent standard in electronics and preferably with at least three years' experience in domestic HiFi and/or Video equipment. Some experience in technical writing is also essential.

Benefits include competitive salary, four weeks' holiday, subsidised restaurant, contributory pension scheme and private health cover.

For further information or an application form, please contact:

Mrs C. A. Burrige, Pioneer High Fidelity (GB) Limited
Field Way, Greenford, Middx. UB6 8UZ. Tel: 01-575 5757

(2196)

ELECTRONICS ENGINEER

Rediffusion Music require an Electronics Engineer with a minimum of five years' experience in the professional audio field, covering real time and high speed magnetic tape duplicating systems.

The successful candidate will be involved with the design, development and technical back-up of studio and factory production equipment. Should be qualified to degree or HND level, and will be expected to have proven supervisory and communication skills.

For application form please contact:

Mrs Joanne Jarvis
Personnel Officer
Rediffusion Business Electronics Ltd.
Music Division
Cray Avenue
Orpington
Kent
Tel: Orpington 32121

(2193)

INNER LONDON EDUCATION AUTHORITY

Learning Resources Branch
Television Centre
Thackeray Road
Battersea SW8 3TB

ENGINEER - ELECTRONIC MAINTENANCE

Salary range: (ST2) £7,035 to £7,974 plus £1,284 London Weighting Allowance.

The ILEA's Television Centre produces a wide range of educational programmes on video and audio cassettes.

The Maintenance section numbers four persons and a vacancy has arisen for an engineer with a sound knowledge of the principles of colour television, and preferably a working experience of maintaining broadcast type TV equipment. Applicants must wish to specialise on the video side (cameras, vision mixers, telecine, etc.), and will receive appropriate training.

An engineering degree, TEC or other equivalent qualifications are desirable.

Application forms from the Education Officer (EO/Estab. 1B), Room 365, The County Hall, London SE1 7PB. Please enclose a stamped and addressed foolscap envelope. Completed forms to be returned by May 4, 1983.

ILEA is an equal opportunities employer.

(2201)



TELEVISION AUDIO MAINTENANCE LIMITED

TECHNICAL TRAINING OFFICER

Television Audio Maintenance (TAM) is an expanding national Division of the Telefuson Plc Group (£80 million turnover) providing a Video/TV/Audio after sales service to leading electrical retailers, all of whom are household names.

This interesting and challenging new appointment will be of interest to engineers of City and Guilds Technician Education or equivalent who wish to broaden their experience across a wide range of modern merchandise and manufacturers. Applicants should preferably have had teaching or training experience.

The work involves conducting Central and Regional Courses, preparing material to be used by our national network of Local Trainers, providing technical servicing advice to our 50 Service Departments and liaising with manufacturers. The position is based at Blackpool. Considerable travelling is involved.

Salary is negotiable. Company car plus other fringe benefits. Reply with full details to:

Mr. R. M. Beaton, Group Personnel Manager,
Telefuson Plc, Telefuson House, Preston New Road,
Blackpool, Lancs.

(2198)

THE PAPUA NEW GUINEA UNIVERSITY OF TECHNOLOGY DEPARTMENT OF ELECTRICAL AND COMMUNICATIONS ENGINEERING

PROFESSOR AND ASSOCIATE PROFESSOR (2 VACANCIES)

Applications are invited from suitably qualified candidates to fill the above posts. The Holder of the Chair of Electrical and Communications Engineering would be expected to assume leadership of the Department. The discipline of the Associate Professor would be chosen to complement that of the Professor.

The Department of Electrical and Communications Engineering has a current academic staff of 16, and a total student enrolment of 190. The Department is responsible for courses leading to a Bachelor's Degree with specialisation in either communication or power engineering, and to a Diploma or Graduate Diploma leading to a Master's Degree after further study, has recently been introduced. There is scope for developing related courses within the Department.

The applicants should have appropriate qualifications and extensive teaching and administrative experience in higher education, special expertise in some branch of electrical and communication engineering, and a recognition of some of the problems facing technological education in a developing country. He/she will be required to stimulate and pursue research and maintain and develop strong links with engineering employers and the profession.

The language of instruction is English.

SALARY:	Professor	K22,840
	Associate Professor	K21,720
	(K1=£0.7591)	

Initial contract period is for three years. Other benefits include gratuity of 24% taxed at 2%, appointment and repatriation fares for the staff member and family after 18 months of service, settling-in and settling-out allowances, six weeks paid leave per year, education fares and assistance towards school fees, free housing. Salary continuation and medical schemes are available.

Detailed applications with curriculum vitae together with names and addresses of three referees and telephone contact should be received by: The Registrar, PNG University of Technology, Private Mail Bag, Lae, Papua New Guinea by 31st August, 1983. (2186)

SALFORD COLLEGE OF TECHNOLOGY

DEPARTMENT OF ENGINEERING

LECTURER IN ELECTRONICS (AUDIO/MUSIC RECORDING)

Lecturer required from 1 September, 1983, to assist in the development of new three year full-time Diploma course in Music Recording Technology.

Candidates must have a degree in Electronics or Physics and should have practical experience of analogue and digital equipment. An ability and/or interest in music is essential.

In addition to teaching on the Music Recording Technology course the successful candidate will be required to teach on other full-time and part-time day courses in Electronics and related studies.

Further details and application forms (to be returned as soon as possible) are available from the Principal, Salford College of Technology, Frederick Road, Salford M6 6PU. Tel: 061-736 6541. (2200)

Due to expansion

STUDIO 99 VIDEO

Required a further

VIDEO ENGINEER

for bench and field work

Duties involve the maintenance and installation of professional video equipment. A candidate should be familiar with three tube colour cameras, U-Matic format video recorders and associated equipment.

Whilst a technical qualification is desirable, a minimum of five years' experience is required. This is an interesting job requiring a high level of expertise and self-motivation.

If you can match up to these expectations we would like to hear from you.

Company vehicle provided, salary commensurate with experience.

Please contact Mr Stone or Miss Whittick on 01-450 1313

(2171)

TRANSMITTER/STUDIO ENGINEERS

LONDON BASED

Up to £13,000

These positions require Engineers with a considerable experience in the design and installation of transmission and studio equipment. FM, MW/SW up to 100KW and TV up to 30KW. The job entails overlooking an operation from the initial contract through to installation and as most of these are abroad, candidates must be prepared to spend up to 50% of the year outside the U.K. A working knowledge of French or German would be an advantage.

For an application form, please send your name and address to George Lowi, Beechwood Appointments Register, 221 High Street, LONDON W3 9BY or telephone 01-992 8647 (24-hour answering service).

(2204)



ELECTRONICS ENGINEER

committed to Third World Development

to develop simple solar voltaic products and assist in establishing small scale manufacturing units in Botswana.

Practical experience of design and construction of electronic devices essential.

Two-year contracts including modest living allowance and flights. Regret no funding for dependants.

Write for details including short c.v. and s.a.e. to: International Voluntary Service, WW1, 53 Regent Road, Leicester LE1 6YL.



(2170)

TOWNLEY EMPORIUM

Bargains for callers or send for catalogue

ELECTRICAL, ELECTRONIC & MECHANICAL COMPONENTS

Vast range of surplus test equipment; Diodes; Thyristors; Resistors; Terminals; Switches; Relays; Screws; ICs; Tools.

Harehill Street off Bursley Road, Todmorden, Lancs OL14 5JY

(2172)

UNIVERSITY COLLEGE LONDON

Department of Phonetics & Linguistics

RESEARCH ASSISTANT HEARING RESEARCH

PHYSICIST required to work in the field of electrocochlear stimulation in the totally deaf. A new five-year MRC-funded post (starting July 1983) in an established multi-disciplinary group with collaborating members in London (University College London and Guy's Hospital) and Cambridge (Laboratory of Experimental Psychology). The successful applicant will be based in London. Work involves speech signal processing, biocompatible materials, practical prosthesis design and work with individual patients. Preparation for a higher degree is possible. Salary £7,190 - £1,186 London Allowance.

Applications (no form) should be sent to Professor A. J. Fourcin, Department of Phonetics & Linguistics, University College London, Wolfson House, 4 Stephenson Way, London NW1 2HE.

(2178)

UNIVERSITY OF YORK

SENIOR TECHNICIAN Grade 5

(Salary scale £6279-£7332)

Department of Psychology

A vacancy exists for a post of Electronic/Computer Technician in the Department's electronic workshop. The work will primarily involve the construction and development of interface systems and the maintenance of mini- and micro-computers.

Applicants are expected to have appropriate technical qualifications. Experience with PDP-11 type computers and a knowledge of Macro 11 assembly language would be an advantage.

Applications should be sent, together with the names and addresses of two referees, to Mr. D. Rymer, Assistant Bursar, University of York, Heslington, York YO1 5DD to arrive not later than 31 July.

(2205)

ARTICLES FOR SALE

MARCONI UHF SIGNAL GENERATOR

£79/Co0 Corrector £39. Wow/Flutter Meter £75. B.E. Double Pulse Generator £49. Wayne-Kerr Audio Analyser £45. Signal/Sweep Generators. Siemens Chart Recorder with Level Meter facility £49. Vibration Analyser £69. Pye Megohmmeter 200,000 M-ohm £47. Hivolt Linear Scale 30KV EHT Meter £32. Micro-Indexing Tables with electronic control, contractors, etc £295. 7-channel 1" tape recorder, six speeds £98. Valradio 50-60 c/s Static Converter £39. Swiss micro-lathe £45. Vortexion mixer 3-ch +ppm £45. 4-ch -cue lights £49. Leavers-Rich professional recorder 12v DC £95. 1" recording tapes NAB £4 ea. Marconi Double Pulse Generator £75. Hatfield Static Converter 50c/s in. 290-550c/s out. £75. Grubb Parsons Argon Analyser £50. Sullivan Precision Decade Mica Condenser, total 1uf £45. 040-376236. (2016)

BRIDGES, waveform/transistor analysers. Calibrators, Standards. Millivoltmeters. Dynamometers. KW meters. Oscilloscopes. Recorders. Signal generators - sweep, low distortion, true RMS, audio, FM, deviation. Tel. 040 376236.

VALVES, PROJECTOR Lamps, 6090 types, list 75p, world wide export. Cox Radio (Sussex) Ltd., The Parade, East Wittering, Sussex. Phone (024 366,2023. (1991)

Challenging Opportunities with Sony Broadcast Ltd.

We are one of the World's leaders in the professional broadcast industry with our international headquarters for Europe, the Middle East and Africa located in North Hampshire. Continued growth and success has resulted in the following exciting opportunities:

Field Service Engineer

To be engaged in the service and repair of our extensive range of equipment, including video cameras, VTR/VCR's, and editing control systems. A high level of self motivation and initiative is required in order to successfully undertake customer visits throughout our marketing territory.

Senior Quality Assurance Engineer

To join a small team responsible for the evaluation of product performance. Responsibilities will include commissioning and assistance in product customisation. This will involve liaison with customers and the ability to effectively maintain this interface is essential.

Applicants, aged 25 plus, should have a background in broadcast television equipment supported by a relevant electronics qualification.

We offer a first class working environment in our prestigious engineering complex, together with an attractive salary and excellent conditions of employment, which include Company Pension/Life Assurance Schemes and private medical cover.

If you are interested please write with details of present salary and career to date to: David Parry, Assistant Personnel Officer, Sony Broadcast Limited, City Wall House, Basing View, Basingstoke, Hampshire RG21 2LA. Telephone Basingstoke (0256) 55011



Sony Broadcast Ltd.

City Wall House
Basing View, Basingstoke
Hampshire RG21 2LA
United Kingdom
Telephone (0256) 55 0 11

(2182)

SITUATIONS VACANT

The Papua New Guinea University of Technology Department of Electrical and Communications Engineering

Lecturer

Applications are invited for the above position in the Department of Electrical and Communications Engineering.

Candidates should preferably have experience in teaching communications engineering subjects to degree level. An interest in HF and UHF amateur radio techniques or satellite communication would be preferred. A higher degree would be an advantage.

SALARY: - Lecturer K16,020 - K17,870 (K1 = £0.7591)

Appointment level will depend upon qualifications and experience.

Initial contract period is for approximately three years. Other benefits include a gratuity of 24% taxed at 2%, appointment and repatriation fares, leave fares for the staff member and family after 18 months of service, settling in and settling-out allowances, six weeks paid leave per year, education fares and assistance towards school fees. Free housing, salary protection plan and medical benefit schemes are available.

Detailed applications with curriculum vitae together with the names and addresses of three referees and telephone contact should be received by:

The Registrar, PNG University of Technology, Private Mail Bag, Lae, Papua New Guinea by 31st August, 1983. (2187)

HIGHLAND HEALTH BOARD DEPARTMENT OF MEDICAL PHYSICS AND BIO- ENGINEERING, RAIGMORE HOSPITAL, INVERNESS

SENIOR TECHNICIAN/ TECHNICIAN Electronics Section

A vacancy exists for a Senior Technician or Technician (MPT Grade III or IV). The work involves design, construction, repair and maintenance as well as clinical involvement.

**Salary is: Grade III £6132-£7926
Grade IV £5171-£6798**

National Health Service Conditions of Service.

A full job description and application form can be obtained from Area Personnel Officer, Highland Health Board, Reay House, 17 Old Edinburgh Road, Inverness.

For additional information contact Mr. A. R. Bowley, Deputy Director. Tel: Inverness (0463) 34151, Ext 276 or 277. (2206)

CAPITAL APPOINTMENTS LTD

THE UK'S No. 1 ELECTRONICS AGENCY

If you have HNC/TEC or higher qualifications and are looking for a job in design, test, customer service, technical sales or similar fields:

**Telephone now for our free jobs list
We have vacancies in all areas of the UK
Salaries to £15,000 pa**

**01-637 5551 or 01-636 9659
(24 hours)**

Or if you prefer send a FULL CV to:

**CAPITAL APPOINTMENTS LTD
29-30 WINDMILL STREET, LONDON W1P 1HG**

(291)

WAVEGUIDE, Flanges and Dishes. All standard sizes and alloys (new material only) from stock. Special sizes to order. Call Earth Stations, 01-228 7876, 22 Howie Street, London SW11 4AR. (2099)

LAMPS AND CABLE. Large amount of lamps and cable for sale - all types and sizes, domestic and industrial. Telephone MIRAGE LIGHTING on HITCHIN (0462) 733388 between 10am-7pm. (1809)

FREE PROTOTYPE of the finest quality with EVERY P.C.B. artwork designed by us. Competitive hourly rates, and high standard of work. Halstead Designs Limited. Tel: Halstead (0787) 477408. (2126)

BATCH PRODUCTION wiring and assembly to sample or drawings. McDeane Electricals Ltd, 19b Station Parade, Ealing Common, London W5. Tel: 01-992 8976. (169)

ARTICLES FOR SALE

TO MANUFACTURERS, WHOLESALERS BULK BUYERS, ETC. LARGE QUANTITIES OF RADIO, TV AND ELECTRONIC COMPONENTS FOR DISPOSAL

SEMICONDUCTORS, all types, INTEGRATED CIRCUITS, TRANSISTORS, DIODES, RECTIFIERS, THYRISTORS, etc. RESISTORS, C/F, M/F, W/W, etc. CAPACITORS, SILVER MICA, POLYSTYRENE, C280, C296, DISC CERAMICS, PLATE CERAMICS, etc.

ELECTROLYTIC CONDENSERS, SPEAKERS, CONNECTING WIRE, CABLES, SCREENED WIRE, SCREWS, NUTS, CHOKES, TRANSFORMERS, etc.

ALL AT KNOCKOUT PRICES - Come and pay us a visit ALADDIN'S CAVE.

TELEPHONE: 445 0749/445 2713

BROADFIELDS & MAYCO DISPOSALS

21 Lodge Lane, North Finchley, London, N.12

(5 minutes from Tally Ho Corner) (1613)

QUARTZ CRYSTALS IN 24 HOURS ANY FREQUENCY 2-50 MHz FOR £5 inc

New fast service for C.W.O. only (state holder style).
Clock oscillators for microprocessors in stock from £9.30.

McKnight Crystal Co Ltd, Hardley Industrial Estate

Mythe, Southampton SO4 6ZY Tel. 0703 848961

(2008)

RACAL COMMUNICATION RECEIVERS

500kc/s to 30mc/s in 30 bands 1mc/s wide, RA17 MK11 £100, RA17L £150, RA17E £225. New metal louvered cases for above £25 each. All receivers are air tested and calibrated in our workshop. Supplied with manual and dust cover, in fair used condition. RACAL SYNTHESISERS (Decade frequency generator) MA3508 Solid state for use with MA79 - RA117 - RA217 - RA1217 ETC. £100 to £150. MA250 16mc/s to 31.6mc/s £100 to £150. MA2506 PRECISION FREQUENCY STANDARD 5mc/s, 1mc/s 100kHz £100 to £150. EDDYSTONE RECEIVER TYPE EC64/7K Solid state, single channel, SSB, mains or battery powered, 1.6 to 27.5mc/s and 400, 535kHz £100 with manual. REDIFON SSB RECEIVER TYPE R499 Solid state, 10 fixed channels, range 1.5 to 30mc/s and 25kHz to 525kHz, power mains or battery, complete with ISB adaptor AR10A, £100 with manual. REDIFON TT11 AUDIO TELEPRINTER CONVERTOR Solid state, tested with circuit £25. CREED TYPE 75 TELEPRINTER 50 and 75 bauds for use with above convertor £25.

OSCILLOSCOPES

COSSOR CDU150 35mc/s, twin beam, solid state £195 with manual. TEKTRONIX 422 Solid state, portable with internal battery pack, 15mc/s, dual trace £350. CT436 DUAL BEAM Oscilloscope, 6mc/s to 75. TEKTRONIX 647A 100mc/s, dual trace, solid state £350 with manual. MARCONI TP995 SIGNAL GENERATORS From 2mc/s or 1.5mc/s to 220mc/s. AM-FM, A2M £100, A3 £100, A5 £100, B5 £250 with manuals. TP200SR Two tone signal source audio £150. TP250 DIFFERENTIAL DC VOLT METER 0 to 1100volts £100. TP2002 AM SIGNAL GENERATOR 10kc/s to 72mc/s £400. TP2002AS FM and AM signal generator, 10kc/s to 72mc/s - £600. TP2127 DIGITAL SYNCHRONIZER For above £350. TP1068/6 FM-AM SIGNAL GENERATOR 10mc/s to 470mc/s £200. TP245 CIRCUIT MAGNIFICATION METER and TP1246 Oscillator £200. H.P. SIGNAL GENERATOR £200. 7 to 11 giga £100. H.P. SIGNAL GENERATOR 600 10-420mc/s - £70. MARCONI AF WATT METER CT44 NOT Absorption, 200 microwatts to 6 watts, in 10 ranges switched, 2.5ohms to 20K ohms £45. TP950A AF WATT METER 1 milliwatt to 10 watts 2.5ohms to 20K ohms in 48 steps £65. THYRISTOR TEST SET, CT556 Voltages up to 2KV £100. TEKTRONIX 4002A GRAPHIC COMPUTER TERMINAL with joystick £1200. TEKTRONIX 4601 Hard copy unit for use with above £450. Both units for £1550. RACAL DIGITAL COUNTERS, TYPE 801M - 125mc/s £50. RACAL 836 COUNTER 35mc/s £50.

VAT AND CARRIAGE ON ABOVE ITEMS EXTRA

All items are bought direct from H.M. Government, being surplus equipment. Price is ex works.

SAE for all enquiries. Phone for appointment for demonstration of any item.

JOHN'S RADIO, WHITEHALL WORKS, 94 WHITEHALL ROAD EAST, BIRKENSHEAD, BRADFORD BD11 2ER

TEL: (0274) 684007 (848)

THE SCIENTIFIC WIRE COMPANY

811 Forest Rd, London, E.17. Tel. 01-531 0574

ENAMELLED COPPER WIRE

SWG	1lb	8oz	4oz	2oz
8 to 34	£3.63	£2.09	£1.10	£0.89
35 to 39	£3.82	£2.31	£1.27	£0.93
40 to 43	£6.00	£3.20	£2.25	£1.61
44 to 47	£8.67	£5.80	£3.49	£2.75
48	£15.96	£9.58	£6.38	£3.69

SILVER PLATED COPPER WIRE

14 to 30	£9.09	£5.20	£2.93	£1.97
----------	-------	-------	-------	-------

TINNED COPPER WIRE

14 to 30	£3.97	£2.41	£1.39	£0.94
Fluoresce Solder	£5.90	£3.25	£1.82	£0.94

Prices include P.P. and VAT. Orders under £2 add 20p. S.a.e. for list of copper and resistance wire. Dealer enquiries welcome. (9063)

1000 INSTRUMENT HANDBOOKS FOR SALE

Large range of well-known manufacturers - H.P., Tek, Air-mec, etc.

Send s.a.e. for price list. Martin Associates (Electronics) Limited,

Parthia House, Beckhamton, Nr. Marlborough, Wilts SN8 1QJ

(2180)

OPERATIONAL AMPLIFIER EXPERIMENTAL MANUAL

by G. B. Clayton £3.50

DIGITAL ELECTRONIC CIRCUITS & SYSTEMS £5.50

by N. M. Morris

ELECTRONIC MUSIC CIRCUITS £15.00

by B. Klein

THE CATHODE-RAY OSCILLOSCOPE AND ITS USE £5.50

by G. N. Patchett

VIDEOTAPE RECORDING £14.50

by J. F. Robinson

DOMESTIC VIDEO CASSETTE RECORDERS £15.00

by S. Beeching

A SERVICING GUIDE £15.00

MICRO COOKBOOK VOL 1: FUNDAMENTALS £13.50

by D. Lancaster

AN INTRODUCTION TO MICROCOMPUTERS VOL 1: BASIC CONCEPTS £10.50

by A. Osborne

WORLD RADIO TV HANDBOOK £12.00

by J. Frost

1983 THE RADIO AMATEUR'S H/B £10.00

by A.R.R.L.

★ ALL PRICES INCLUDE POSTAGE ★

THE MODERN BOOK CO.

BRITAIN'S LARGEST STOCKIST of British and American Technical Books

19-21 PRAED STREET LONDON W2 1NP

Phone 01-402 9176

Closed Saturday 1 p.m.

Please allow 14 days for reply or delivery (2023)

INVERTERS

High-quality DC-AC; also "no break" (2ms) static switch, 19in. rack. Auto Charger.

COMPUTER POWER SYSTEMS -

Intorport Mains-Store Ltd. POB 51, London, W11 3BZ

Tel: 01-727 7042 or 0225 310916 (9101)

WIRELESS WORLD AUGUST 1983

ARTICLES FOR SALE



24 COLUMN PRINTER ONLY £69 EACH (inclusive)

Standard 4-inch 3U mounting; inverted 4 double sized print; single 9V AC or 5V DC power supply; standard centronics interface or serial data; extends only 40mm behind panel.

For further details contact: **Benwick Electronics** 9 Doddington Road, Benwick nr March, Cambs. PE15 0UX Telephone: Benwick (035477) 471

3 COMPARTMENT ICI ULTRASONIC CLEANER

Offers: Laminar Clean Air Bench £475. Unitex 2-127-05 Parallel Gap Welding Head, c/w P.S.U. & Foot Pedal. Unused - £450.

Phone: (067 23) 219 (2179)

ENCAPSULATING EQUIPMENT FOR coils, transformers, components, degassing silicone rubber, resin, epoxy. Lost wax casting for brass, bronze, silver, etc. Impregnating coils, transformers, components. Vacuum equipment, low cost, used and new. Also for CRT regunning metallising. Research & Development. Barratts, Mayo Road, Croydon CR0 2QP. 01-684 9917. (9678)

Analogue integrated circuit design on a single chip. Phone Four-D Limited on 0279-29246. 2159

ARTICLES WANTED

WANTED

Test equipment, receivers, valves, transmitters, components, cable and electronic scrap, and quantity. Prompt service and cash. Member of A.R.R.A.

M & B RADIO 86 Bishopsgate Street Leeds LS1 4BB 0532 35649

WANTED

Redundant test equipment - receiving and transmitting equipment - valves, plugs and sockets - synchros etc.

Phone: **Johns Radio** 0274 684007
84 Whitehall Road
East Birkenshaw
Bradford BD11 2ER (2049)

AVO Model 8 Test Meters.

Quantity available. Brand new with leather carrying case. Ex-Government issue, needing slight electrical and mechanical adjustments. £45 each

Burgess Lane & Co. Ltd., Thornton Works, 1A Thornton Avenue, London W4 1QE. 01-994 5752. (2194)

WANTED

Redundant/surplus electronic components and equipment. Telephone and computer spares.

Prompt service and payment. **J. B. PATTRICK (Electronics)** 191/193 London Road Romford, Essex Romford 44473 (1979)

WANTED

Redundant/surplus electronic components and equipment. Telephone and computer spares. Prompt service and payment. **J. B. PATTRICK (Electronics)** 191/193 London Road Romford, Essex Romford 44473 (1979)

WIRELESS WORLD AUGUST 1983

SURPLUS

Top prices paid for surplus, redundant and obsolete test equipment, factories cleared. Also quantities of components. Immediate settlement. We will call anywhere in the United Kingdom.

TIMEBASE

94 Alfriston Gardens Shelling, Southampton SO2 8FU Telephone: (0703) 431 323 (1852)

ANTIQUE RECEIVING VALVES

Unused and boxed In large quantity

Tsutom Yoshihara C1-105, Deguchi-cho 34 Suita-shi, Osaka 564 JAPAN (2055)

LINSLEY HOOD DESIGNS

75Watt and 100W amps Audio Signal Generators

75Watt amp p.c.b. £2.30

100Watt Mosfet p.c.b. £4.00

p&p 50p

S.A.E. for leaflets

TELERADIO ELECTRONICS 325 Fore Street, London N9 0PE (1762)

EX WD Radio equipment and test equipment. Over 500 sets in stock from £8. Send 50p for illustrated catalogue (including £1 voucher). Weirhead Ltd, 129 St. Albans Road, Watford, Herts. Tel: Watford (0923) 49456. (1974)

CAPACITY AVAILABLE

QUAD VALVE AMPLIFIERS. Garrard 301 & 401, all types of valve equipment, please ask for "Wanted List". All valve amplifiers repaired. The Vintage Wireless Company, 64 Broad Street, Staple Hill, Bristol BS16 5NL. (0272) 565472. (2149)

P.C.B.'s

Printed Circuit Boards to your specification from artwork through to finished board.

QUICK DELIVERY - COMPETITIVE PRICES

CROFTON ELECTRONICS LIMITED 35 Grosvenor Road, Twickenham, Middlesex TEL: 01-891 1923/1513 Telex: 295093

PCB/ELECTRONIC ASSEMBLY

★ Circuit Design & Development
★ Prototyping
★ Pre-production Consultancy
★ Full Production Capability
★ Component Sourcing & Stocking
★ Complete Test Facilities

STAGECRAFT (ELECTRONICS) LTD 3 Churchfield Road Acton Central, W3 6BH Tel: 01-993 1852/3660 (2203)

PCB/ELECTRONIC ASSEMBLY

★ Circuit Design & Development
★ Prototyping
★ Pre-production Consultancy
★ Full Production Capability
★ Component Sourcing & Stocking
★ Complete Test Facilities

STAGECRAFT (ELECTRONICS) LTD 3 Churchfield Road Acton Central, W3 6BH Tel: 01-993 1852/3660 (2203)

PCB/ELECTRONIC ASSEMBLY

★ Circuit Design & Development
★ Prototyping
★ Pre-production Consultancy
★ Full Production Capability
★ Component Sourcing & Stocking
★ Complete Test Facilities

STAGECRAFT (ELECTRONICS) LTD 3 Churchfield Road Acton Central, W3 6BH Tel: 01-993 1852/3660 (2203)

PCB/ELECTRONIC ASSEMBLY

★ Circuit Design & Development
★ Prototyping
★ Pre-production Consultancy
★ Full Production Capability
★ Component Sourcing & Stocking
★ Complete Test Facilities

STAGECRAFT (ELECTRONICS) LTD 3 Churchfield Road Acton Central, W3 6BH Tel: 01-993 1852/3660 (2203)

WIRELESS WORLD AUGUST 1983

SERVICES

CIRCOLEC THE COMPLETE ELECTRONIC SERVICE

Artwork, Circuit Design, PCB Assembly, Test & Repair Service, Q.A. Consultancy, Prototypes, Final Assembly.

Quality workmanship by professionals at economic prices.

Please telephone 01-646 5686 for advice or further details.

Unit 4, Windmill Trading Estate Commonside East, Mitcham (1391)

FOR THE BEST PCB SERVICE AVAILABLE

★ Circuit Design & Development Digital and Analogue

★ Artwork Layout Work of the highest standard by experienced draughtsmen. No minimum charge.

★ Board Manufacture Prototype to semi-production, excellent rates. 24-hour prototype service from filmwork.

★ Wiring & Assembly PCB assembly, wiring and cable forming by qualified staff.

★ Test Full test facilities available.

One or all services available, no order too small. Please telephone Chelmsford (0245) 357355, or write to HCR Electronics, The Industrial Unit, Parker Road, Chelmsford. (1169)

PRINTED CIRCUIT BOARDS

Manufacturers from A/W or film, small or large quantities, average turnaround two weeks.

MAYLAND PCB CO. LTD. Maylandes Chelmsford, Essex CM3 6AB Tel: (0621) 741560 (2051)

EPROM PROGRAMMING

From list and/or existing EPROM for most 5v N.MOS types. Charge £2.50 + 12 pence per 32 words manually entered. Erasing and EPROMS also available.

Bandley Chipware 28 Boroughgate Appleby Cumbria CA16 6AG Tel: 0930 51027 (2202)

TURN YOUR SURPLUS

Capacitors, transistors, etc. into cash. Contact COLES-HARDING & Co., 103 South Brink, Wisbech

COMPUTER APPRECIATION

will shortly be moving to Oxford

Prior to our move we shall be selling by auction our entire stock on August 15th. Lots (many without reserve) will include: Complete systems (by DEC, Hewlett Packard, NCR, Texas Instruments); VDU Terminals (by Newbury Labs, Hazeltine and others); Hard and Floppy disc drives; DEC peripherals; Microscopes; Lasers; Printers (daisy wheel golfball and matrix) by DIABLO, TALLY, IBM; Mag tapes; NAGRA Sound Recorder; TEKTRONICS Model 335 oscilloscope; Word processors; paper tape equipment by FACIT, CLARY, TALLY; plotters, cardreaders, monitors, modems

Catalogues available (price £1 incl. postage) from:

Computer Appreciation, 86 High Street, Bletchingley, Redhill, Surrey RH1 4PA
Tel: Godstone (0883) 843221

Lawrences, Norfolk House, High Street, Bletchingley, Surrey

INDEX TO ADVERTISERS

Appointments Vacant Advertisements appear on pages 94-103

PAGE	PAGE	PAGE
Aero Electronics (AEL) Ltd..... 4	Farnell Instruments Ltd. Cover ii, 20	Pantechnic 77
Ambit International 8	Ferranti Electronics Cover iv	PM Components 18, 19
Armon Electronics Ltd. 14	Fieldtech Heathrow Ltd. 20, 77	P&R Computer Shop 83
Aspen Electronics Ltd. 88		
Audio Electronics (Cubegate) Ltd 9		
Avel Lindberg (Cotswold Electronics) 14		
	G.P. Industrial Electronics Ltd..... 10, 11	
	Griftronic Emission Ltd..... 4	
Bamber, B. Electronics 80		Racom Ltd. 91
Barrie Electronics Ltd. 89	Harris Electronics (London) 7	Radford Audio Ltd. 80
Black Star Ltd. 91	Harrison Bros. Electronic Distributors 3	Radio Component Specialists 81
Branson, S. J. 91	Hart Electronic Kits Ltd. 6	RST Valves 13
Broadfields & Mayco Disposals 6	Hemmings Electronics and Microcomputers 77	
	Henry's Computer Shop 18	
	Hilomast Ltd. 5	
	House of Instruments 15	
	H.W. International Cover iii	
Cherry Electrical Products 2		Samsons (Electronics) 92
Circuit Services 89		Service Trading Co. Ltd. 91
Clark Masts Ltd. 83		Skyleader 92
Clef Products (Electronics) Ltd. 80		South Midland Communications Ltd. 2
Colomor (Electronics Ltd.) 83		Sowter, E. A. Ltd. 7
Computer Appreciation 104	Integrex Ltd. 8	Special Products (Distributors) Ltd. 3
Control Universal Ltd. 4	ILP Electronics Ltd. 12, 16, 17	Stewart of Reading 88
Cricklewood 85		Strumech Engineering Ltd. 15
		Surrey Electronics Ltd. 14
	Langrex Supplies Ltd. 13	
Delph Electronics 6		
Display Electronics 93	Midwich Computer Co. Ltd. 7	Technomatic Ltd. 78, 79
	Micro Concept 84	Techtest Ltd. 2
		Thandar Electronics Ltd. 84
		Thanet Electronics Ltd. 4
		Thomas Business Systems 2
		Thurlby Electronics (Reltech) 12
		Timebase Ltd. 80
Eddystone Radio 88	Northern Computer Fair 86	
Electrical Review Shock Cards 83	Nova Products (APB) Ltd. 88	
Electronic Brokers Ltd. 3, 5		
Electrostatic Ltd. 18		
Electrovalue Ltd. 92	Opus Supplies 87	
Essex Electronics Centre 9	Orion Scientific Products Ltd. 14	Wireless World Circards 90

OVERSEAS ADVERTISEMENT AGENTS
France & Belgium: Norbert Hellin, 50 Rue de Chemin Veat, F-9100, Boulogne, Paris.

Hungary: Ms Edit, Bajusz, Hungexpo Advertising Agency, Budapest XIV, Varosliget.
Telephone: 225 008 - Telex: Budapest 22-4525 INTFOIRE

Italy: Sig C. Epis, Etas-Kompass, S.p.a. - Servizio Estero, Via Mantegna 6, 20154 Milan.
Telephone: 347051 - Telex: 37342 Kompass.

Japan: Mr. Inatsuki, Trade Media - IBPA (Japan), B.212, Azabu Heights, 1-5-10 Roppongi, Minato-ku, Tokyo 106.
Telephone: (03) 585 0581.

United States of America: Ray Barnes, Business Press International Ltd, 205 East 42nd Street, New York, NY 10017 - Telephone (212) 867-2080 - Telex: 238327.

Jack Farley Jr., The Farley Co., Suite 1584, 35 East Walker Drive, Chicago, Illinois 60601 - Telephone (312) 63074.
Victor A. Jauch, Elmatex International, P.O. Box 34807, Los Angeles, Calif. 90034, USA - Telephone (213) 821-8581 - Telex: 18-1059.

Jack Mantel, The Farley Co., Suite 650, Ranna Building, Cleveland, Ohio 44115 - Telephone (216) 621 1919.
Ray Rickles, Ray Rickles & Co., P.O. Box 2028, Miami Beach, Florida 33140 - Telephone (305) 532 7301.
Tim Parks, Ray Rickles & Co., 3116 Maple Drive N.E., Atlanta, Georgia 30305. Telephone (404) 237 7432.
Mike Loughlin Business Press International, 15055, Memorial Ste 119, Houston, Texas 77079 - Telephone (713) 783 8673.

Canada: Colin H. MacCulloch, International Advertising Consultants Ltd., 915 Carlton Tower, 2 Carlton Street, Toronto 2 - Telephone (416) 364 2269.
* Also subscription agents.

Printed in Great Britain by QB Ltd, Sheepen Place, Colchester, for the proprietors, Business Press International Ltd, Quadrant House, The Quadrant, Sutton, Surrey SM2 5AS.
© Business Press International Ltd 1983. Wireless World can be obtained abroad from the following: AUSTRALIA and NEW ZEALAND: Gordon & Gotch Ltd. INDIA: A. H. Wheeler & Co. CANADA: The Wm. Dawson Subscription Services Ltd; Gordon & Gotch Ltd. SOUTH AFRICA: Central News Agency Ltd; William Dawson & Son (SA) Ltd.
UNITED STATES: Eastern News Distribution Inc., 14th Floor, 111 Eighth Avenue, New York, NY 10011.

THE WORLD'S FIRST AND ONLY AUTOMATIC MICROPHONE SYSTEM - FROM SHURE.



(Actual size)

Whenever someone has something to say in public, it's often the microphone system that makes or breaks their speech.

Clicks. Pops. Crackles. Background noises and missed syllables. Just a handful of the hazards that can turn a speaker's finest hour into a fiasco.

Which is why we'd like to introduce you to something completely new - the Shure AMS. Microphone, mixer and advanced logic technology, combined in a totally dedicated system.

In short - a sound revolution.

At the heart of the AMS are angle-sensitive microphones. Speak into any one of them within its own 120° 'window of acceptance' and it turns on; change the surrounding audio conditions

IT'S SO SMART IT CAN

'MAKE' SPEECHES

and it compensates. Quickly. Quietly. Automatically.

The rear panel of every AMS mixer features logic terminals that not only give unprecedented flexibility but also eliminate many of the usual adjustments and controls.

As a result no other unit sets up as quickly; handles as easily. And for larger gatherings, AMS mixers combine simply to effectively control over 200 mics.

The new Shure Automatic Microphone System. It makes speeches not mistakes.

SHURE

You simply can't make it any clearer.

WW - 018 FOR FURTHER DETAILS

FERRANTI ZN451 EVALUATION KIT

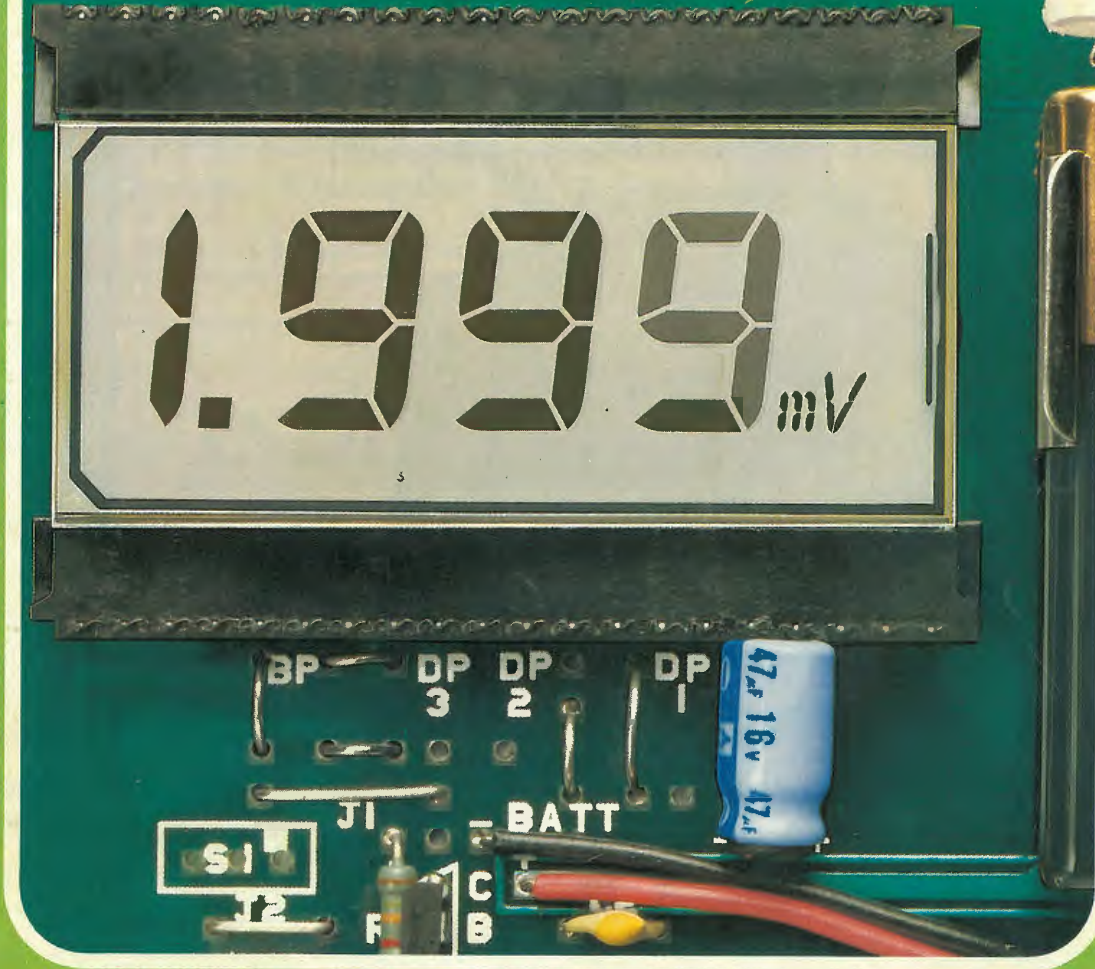

Better by design

If you're the sensitive type, check out the new ZN451 DVM.

Measuring microvolt signal levels is easy with the new ZN451 DVM IC. It's the first DVM that auto-zeroes external signal conditioning circuits to give full-scale readings as low as ± 1.999 mV with no zero adjustment.

Two logic outputs are provided to control external analogue switches, allowing op-amps and other circuits to be put inside the auto-zero loop and have their offsets cancelled by the ZN451's digital auto-zero system.

Use the ZN451 with pressure transducers, thermocouples, strain gauges or any low output transducer.

To make it even easier there's the ZN451 Evaluation Kit, which contains everything* you need to make a 2mV DVM, available from your Ferranti distributor price £29.50 inc. VAT.

Distributors:

Celdis, Reading, Tel: 0734 585171
Farnell Electronic Comps., Leeds,
Tel: 0532-636311
Intel Electronics, Henlow,
Tel: 0462 812505
STC Electronic Services, Harlow,
Tel: 0279 26777
Midwich Computer Co., Bickingham,
Tel: 0379 898751
Semicomps, Keighley, Tel: 0535 65191
Semicomps, Kelso, Tel: 0573 24366
Swift-Sasco, Crawley, Tel: 0293 28700

Ferranti Electronics Limited,
Fields New Road, Chadderton,
Oldham OL9 8NP, England.
Tel: 061-624 0515 and 061-624 6661
Telex: 668038

FERRANTI

Semiconductors

WW-003 FOR FURTHER DETAILS



1980

*Batteries not included